

KROSS

MUSIC WORKSTATION

Parameter Guide

KORG

EDS-i Enhanced Definition
Synthesis - integrated

REMS

GENERAL
MIDI

About this manual

The manuals and how to use them

The KROSS comes with the following manuals.

- Quick Start Guide (printed)

The manuals listed below can be downloaded from the Korg website.

- Operation Guide (PDF)
- Parameter Guide (PDF) (this document)
- Voice Name List (PDF)

You can also watch video manuals on the Korg website.

- Video manual

<http://www.korg.co.jp/English/Distributors/> or
<http://www.korg.com/>

Quick Start Guide

This provides a simple explanation of the KROSS's functions. To begin, please read the Quick Start Guide.

Video Manual

This video illustrates the main functionality of the KROSS.

Operation Guide

Put simply, the Operation Guide is designed to answer the question, "How do I do this?"

It explains the names and functions of each part of the KROSS, basic operation, an overview of each mode, how to edit sounds, record on the sequencer, and so on. This guide also explains the basics of effects, the Arpeggiator, Drum Track, and Drum Kits.

Finally, it also contains a troubleshooting guide as well as supplemental information such as a list of specifications.

Parameter Guide (this document)

The Parameter Guide is designed to answer the question, "What does this do?"

Organized by mode and page, the Parameter Guide includes information on each and every parameter in the KROSS.

Voice Name List

The **Voice Name List** lists all of the sounds and setups that are in the KROSS when it is shipped from the factory, including Programs, Combinations, Multisamples, Drumsamples, Drum Kits, Arpeggio Patterns, Drum Track Patterns, Demo Songs, and Template Songs.

PDF versions

The KROSS PDF manuals are designed for easy navigation and searching. They include extensive PDF contents information, which generally appears on the side of the window in your PDF reader and lets you jump quickly to a specific section. All cross-references are hyper-links, so that clicking on them automatically takes you to the source of the reference.

Conventions in this manual

References to the KROSS

The KROSS is available in 88-key, and 61-key models. The manuals refer to all models without distinction as "the KROSS."

Symbols , , Note, Tips

These symbols respectively indicate a caution, a MIDI-related explanation, a supplementary note, or a tip.

Example screen displays

The parameter values shown in the example screens of this manual are only for explanatory purposes, and may not necessarily match the values that appear on the LCD screen of your instrument.

MIDI-related explanations

CC# is an abbreviation for Control Change Number.

In explanations of MIDI messages, numbers in square brackets [] always indicate hexadecimal numbers.

What is REMs * ?

REMS (Resonant structure and Electronic circuit Modeling System) is Korg's proprietary technology for digitally recreating the numerous factors that produce and influence a sound, ranging from the sound-production mechanisms of acoustic instruments and electric/electronic musical instruments, to the resonances of an instrument body or speaker cabinet, the sound field in which the instrument is played, the propagation route of the sound, the electrical and acoustic response of mics and speakers, and the changes produced by vacuum tubes and transistors.

* All other product and company names are trademarks or registered trademarks of their respective holders.

Table of contents

About this manual	ii	9: P-AMP EG (Amp Envelope)	36
Program mode	1	9-1: ENVELOPE	36
PROG Page Select	1	9-2: L-MOD (Level Modulation)	37
0: PROG (Program)	2	9-3: T-MOD (Time Modulation)	38
0-1: MAIN	2	10: P-OSC LFO	39
0-2: TONE (Play Tone Adjust)	3	10-1: 1. WAV (LFO1 Waveform)	39
0-3: MIXER (Play Mixer)	4	10-2: 1. FRQ (LFO1 Frequency)	41
0-4: ARP (Arpeggiator)	4	10-3: 2. WAV (LFO2 Waveform)	42
1: P-INPUT/CTRLS (Input/Controllers)	5	10-4: 2. FREQ (LFO2 Frequency)	42
1-1: AUDIO IN	5	11: P-CMN LFO/KT	42
1-2: CONTROLLERS (Controllers Setup)	6	11-1: LFO.W (Common LFO Waveform)	42
2: P-BASIC	7	11-2: LFO.F (Common LFO Frequency)	43
2-1: VOICE (Voice Mode)	7	11-3: KT.1 (Common Keyboard Track 1)	44
2-2: Note-On (Note-On Control)	8	11-4: KT.2 (Common Keyboard Track 2)	45
2-3: SCALE	10	12: P-AMS MIXER	45
3: P-OSC	11	12-1: 1 (AMS Mixer1)	45
3-1: MS 1 (Multisample 1)	11	12-2: 2 (AMS Mixer2)	50
3-2: MS 2 (Multisample 2), 3-3: MS 3 (Multisample 3),		13: P-ARP (Arpeggiator)	51
3-4: MS 4 (Multisample 4)	13	13-1: SETUP	51
3-5: VEL (Velocity Zone)	13	13-2: SCAN ZONE	52
4: P-PITCH	14	14: P-DRUM TRACK	53
4-1: BASIC	14	14-1: PATTERN	53
4-2: MOD (Modulation)	15	14-2: PROGRAM	54
4-3: PORTA (Portamento)	17	15: P-STEP SEQ (Step Sequencer)	55
5: P-PITCH EG (Pitch Envelope)	18	15-1: BASIC	55
5-1: ENVELOPE	18	15-2: EDIT	56
5-2: L-MOD (Level Modulation)	19	15-3: INST (Instrument)	57
5-3: T-MOD (Time Modulation)	20	15-4: MOD (Modulation)	57
6: P-FILTER	21	15-5: MIX (Mixer)	58
6-1: BASIC	21	16: P-FX ROUTING	59
6-2: MOD (Modulation)	23	16-1: BUS	59
6-3: EG-I (EG Intensity)	24	16-2: SEND	59
6-4: LFO-I (LFO Intensity)	25	16-3: Insert FX Setup	60
6-5: KTRK (Keyboard Track)	26	16-4: MIXER	61
7: P-FILTER EG (Filter Envelope)	28	17: P-IFX	61
7-1: ENVELOPE	28	17-1: IFX1 (Insert Effect1)	61
7-2: L-MOD (Level Modulation)	29	17-2: IFX2 (Insert Effect2), 17-3: IFX3 (Insert Effect3),	
7-3: T-MOD (Time Modulation)	30	17-4: IFX4 (Insert Effect4), 17-5: IFX5 (Insert Effect5),	61
8: P-Amp	32	18: P-MFX (Master Effect)	62
8-1: BASIC	32	18-1: SETUP	62
8-2: MOD (Amp Modulation)	33	18-2: MFX1 (Master Effect 1)	62
8-3: KEYTRK (Keyboard Track)	34	18-3: MFX2 (Master Effect 2)	62
		Program: Function	63
		Extended program functions	67

Combination mode	69	11: MFX (Master)	93
COMBI Page Select	69	11-1: SETUP	93
0: COMBI (Combination)	70	11-2: MFX1 (Master Effect1)	94
0-1: MAIN	70	11-3: MFX2 (Master Effect2)	94
0-2: PROG (Program).....	71	Combination: FUNCTION	94
0-3: MIXER.....	72	Extended combination functions	97
0-4: ARP (Arpeggiator)	73		
1: C-INPUT/CTRL (INPUT/Controllers)	74		
1-1: AUDIO IN	74		
1-2: CONTROLLERS (Controllers Setup)	74		
2: C-TONE ADJ (Tone Adjust)	75		
2-1: TONE ADJUST	75		
2-2: EG ADJUST	76		
3: C-TIMBRE (Timbre Parameters)	77		
3-1: MIDI	77		
3-2: OSC.....	77		
3-3: PITCH	78		
3-4: SCALE.....	78		
4: C-ZONE/DELAY	79		
4-1: KEY ZONE (Keyboard Zone)	79		
4-2: VEL ZONE (Velocity Zone)	80		
4-3: DELAY	81		
5: C-MIDI FILTER	82		
5-1: 1 (MIDI Filter1)	82		
5-2: 2 (MIDI Filter2)	82		
5-3: 3 (MIDI Filter3)	83		
5-4: 4 (MIDI Filter4)	83		
6: C-ARP (Arpeggiator)	84		
6-1: ASSIGN	84		
6-2: A (Setup-A), 6-3: B (Setup-B)	85		
6-4: SCAN ZONE	85		
7: C-DRUM TRACK	86		
7-1: PATTERN	86		
7-2: CHANNEL (MIDI Channel)	87		
8: C-STEP SEQ (Step Sequencer)	88		
8-1: BASIC	88		
8-2: EDIT	88		
8-3: INST (Instruments)	89		
8-4: MOD (Modulation)	89		
9: C-FX ROUTING	90		
9-1: BUS	90		
9-2: SEND	91		
9-3: IFX (Insert Effect Setup)	91		
9-4: MIXER	92		
10: C-IFX	92		
10-1: IFX1 (Insert Effect1)	92		
10-2: IFX2 (Insert Effect2), 10-3: IFX3 (Insert Effect3),			
10-4: IFX4 (Insert Effect4), 10-5: IFX5 (Insert Effect5)	93		

Sequencer mode	99
An overview of Sequencer mode	99
SEQ Page Select	102
0: SEQ	103
0-1: MAIN	103
0-2: PROG (Track Program)	105
0-3: MIX (Track Mixer)	106
0-4: REC (Recording Setup)	107
0-5: ARP (Arpeggiator)	111
1: S-INPUT/CTRL (Input/Controllers)	112
1-1: AUDIO IN	112
1-2: CONTROLLERS	112
2: S-LOOP/TONE	113
2-1: LOOP (Track Play Loop)	113
2-2: TONE ADJ (Tone Adjust)	114
2-3: EG ADJ (EG Adjust)	115
3: S-TRACK (Track Parameters)	116
3-1: MIDI	116
3-2: OSC	116
3-3: PITCH	117
3-4: SCALE	118
4: S-ZONE/DELAY (Zones/Delay)	118
4-1: KEY ZONE (Keyboard Zones)	118
4-2: VEL ZONE (Velocity Zones)	119
4-3: DELAY	120
5: S-MIDI FILTER	122
5-1: 1 (MIDI Filter1)	122
5-2: 2 (MIDI Filter2)	122
5-3: 3 (MIDI Filter3)	123
5-4: 4 (MIDI Filter4)	123
6: S-TRACK EDIT (Track Edit)	124
6-1: SELECT MEASURE TO EDIT	124
7: S-ARP (Arpeggiator)	125
7-1: ASSIGN	125
7-2: A (Arpeggiator-A),	
7-3: B (Arpeggiator-B)	126
7-4: SCAN ZONE	127
8: S-DRUM TRACK (Drum Track)	127
8-1: PATTERN	127
8-2: CHANNEL (MIDI Channel)	128
9: S-STEP SEQ (Step Sequencer)	130
9-1: BASIC	130
9-2: EDIT	130
9-3: INST (Instruments)	131
9-4: MOD (Modulation)	131
10: S-FX ROUTING (Effect Routing)	132
10-1: BUS	132
10-2: SEND	132
10-3: IFX (Insert FX Setup)	133
10-4: MIXER	134
11: S-IFX	134
11-1: IFX1 (Insert Effect1)	134
11-2: IFX2 (Insert Effect2), 11-3: IFX3 (Insert Effect3),	
11-4: IFX4 (Insert Effect4), 11-5: IFX5 (Insert Effect5)	134
12: S-MFX (Master Effect)	135
12-1: SETUP	135
12-2: MFX1 (Master Effect1)	136
12-3: MFX2 (Master Effect2)	136
Sequencer: FUNCTION	137
System Exclusive events supported in Sequencer mode	152
KROSS sequencer file formats	153

Global/Media mode	155
Global/Media Page Select	155
Global mode	156
0: GLOBAL	156
0-1: BASIC	156
0-2: SYSTEM	157
0-3: PREF (System Preference)	158
1: G-MIDI	159
1-1: BASIC (MIDI Basic)	159
1-2: OUT	161
1-3 FILTER	162
2: G-INPUT/CTRL	163
2-1: AUDIO IN	163
2-2: FOOT	164
2-3: CC (MIDI CC# Assign)	165
3: G-USER SCALE	165
3-1: OCTAVE	165
3-2: ALL	166
4: ARP PATTERN (Arpeggio Pattern)	166
4-1: SETUP (Pattern Setup)	167
4-2: EDIT (Pattern Edit)	167
4-3: MODE	168
5: DRUM KIT	169
5-1: DS 1 (Drumsample 1)	170
5-2...4: DS2...DS4 (Drumsample2...4)	172
5-5: VOICE	172
Media mode	
6: MEDIA	174
6-1: FILE	175
6-2: UTILITY	175
6-3: INFO	175
Global, Media: FUNCTION	176
Favorites	187
About the Favorites function	187
FAVORITES-A, B, C, D	188
0-1: 1-4, 5-8, 9-12, 13-16	188
Favorites: Function	189
Audio Recorder	191
Overview of the audio recorder function	191
Recording control	192
Audio Recorder Setup	193
Audio Recorder: Function	195

Effect Guide	197
Overview	197
Effects in each mode	197
Dynamic modulation (Dmod) and Tempo Synchronization	198
FX Control Bus	199
Effect I/O	199
Insert Effects (IFX1-IFX5)	200
In/Out	200
Routing	200
Mixer	202
Controlling the Insert Effects via MIDI	203
Master Effects (MF1, 2)	203
In/Out	203
Routing	204
Mixer	205
Controlling the Master Effects via MIDI	205
Effect/Mixer Block Diagram	206
Single size effects	207
000: No Effect	207
001: Stereo Compressor	207
002: Red Comp	207
003: Stereo Limiter	208
004: Multiband Limiter	209
005: St.MasteringLimiter (Stereo Mastering Limiter)	209
006: Stereo Gate	209
007: St.Parametric 4EQ (Stereo Parametric 4EQ)	210
008: St.Graphic 7EQ (Stereo Graphic 7 Band EQ)	211
009: Stereo Exciter	212
010: Stereo Isolator	212
011: St. Wah/Auto Wah (Stereo Wah/Auto Wah)	213
012: St.Vintage Wah (Stereo Vintage Wah)	214
013: VOX Wah	215
014: St. Random Filter (Stereo Random Filter)	215
015: St.MultiModeFitr (Stereo Multi Mode Filter)	216
016: St. Sub Oscillator (Stereo Sub Oscillator)	217
017: Talking Modulator	217
018: St. Decimator (Stereo Decimator)	218
019: St. Analog Record (Stereo Analog Record)	219
020: OD/Hi.Gain Wah (Overdrive/Hi.Gain Wah)	220
021: St. Guitar Cabinet (Stereo Guitar Cabinet)	221
022: St. Bass Cabinet (Stereo Bass Cabinet)	221
023: Bass Amp Model	222
024: Bass Amp+Cabine (Bass Amp Model+Cabinet)	222
025: Treble Booster	223
026: Tube PreAmp Model (Tube PreAmp Modeling)	223
027: St.TubePreAmp (Stereo Tube PreAmp Modeling)	224
028: Mic Model+PreAmp (Mic Modeling + PreAmp)	224
029: Stereo Phaser	224
030: SmallPHASE (Small Phaser)	225
031: Orange PHASE (Orange Phaser)	225
032: Black PHASE (Black Phaser)	225

033: U-VIBE	225
034: St. Random Phaser (Stereo Random Phaser)	226
035: St. Env Phaser (Stereo Envelope Phaser)	226
036: 2Voice Resonator	227
037: Stereo Tremolo	228
038: TEXTREM (TEX Tremolo)	228
039: St. Env. Tremolo (Stereo Envelope Tremolo)	228
040: Stereo Auto Pan	229
041: St. Phaser+Trml (Stereo Phaser + Tremolo)	230
042: St. Ring Modulator (Stereo Ring Modulator)	231
043: P4EQ - Exciter (Parametric 4-Band EQ - Exciter)	231
044: P4EQ - Wah (Parametric 4-Band EQ - Wah/Auto Wah)	232
045: P4EQ - Phaser (Parametric 4-Band EQ - Phaser)	233
046: Comp - Wah (Compressor - Wah/Auto Wah)	233
047: Comp - Amp Sim (Compressor - Amp Simulation)	234
048: Comp - OD/HiGain (Compressor - Overdrive/Hi.Gain)	234
049: Comp - P4EQ (Compressor - Parametric 4-Band EQ)	235
050: Comp - Phaser (Compressor - Phaser)	235
051: Limiter - P4EQ (Limiter - Parametric 4-Band EQ)	236
052: Limiter - Phaser	236
053: Exciter - Comp (Exciter - Compressor)	237
054: Exciter - Limiter	237
055: Exciter - Phaser	238
056: OD/HG - Amp Sim (Overdrive/Hi.Gain - Amp Simulation)	238
057: OD/HG - Phaser (Overdrive/Hi.Gain - Phaser)	239
058: Wah - Amp Sim (Wah - Amp Simulation)	239
059: Decimator - Amp (Decimator - Amp Simulation)	240
060: Decimator - Comp (Decimator - Compressor)	240
061: AmpSim - Tremolo (Amp Simulation- Tremolo)	240
062: Organ Vib/Chorus (Organ Vibrato/Chorus)	241
063: Rotary Speaker	241
064: Stereo Chorus	242
065: Vintage Chorus	243
066: Black Chorus	243
067: St.HarmonicChorus (Stereo Harmonic Chorus)	244
068: St. Biphase Mod. (Stereo Biphase Modulation)	244
069: Multitap Cho/Delay (Multitap Chorus/Delay)	245
070: Ensemble	245
071: Polysix Ensemble	246
072: Stereo Flanger	246
073: Vintage Flanger	246
074: St. Random Flanger (Stereo Random Flanger)	247
075: St. Env. Flanger (Stereo Envelope Flanger)	247
076: Stereo Vibrato	248
077: St. Auto Fade Mod. (Stereo Auto Fade Modulation)	249
078: Doppler	249
079: Detune	250
080: Pitch Shifter	250
081: Pitch Shift Mod. (Pitch Shift Modulation)	251
082: P4EQ - Cho/Flng (Parametric 4-Band EQ - Chorus/Flanger)	252
083: Comp - Cho/Flng (Compressor - Chorus/Flanger)	252
084: Limiter - Cho/Flng (Limiter - Chorus/Flanger)	253

085: Exciter - Cho/Flng (Exciter - Chorus/Flanger)	253
086: OD/HG - Cho/Flng (Overdrive/Hi.Gain - Chorus/Flanger)	254
087: Phaser - Cho/Flng (Phaser - Chorus/Flanger)	254
088: GrainSftr (Grain Shifter)	255
089: L/C/R Delay	255
090: Stereo/CrossDelay	256
091: St. Multitap Delay (Stereo Multitap Delay)	256
092: St. Mod Delay (Stereo Modulation Delay)	257
093: St. Dynamic Delay (Stereo Dynamic Delay)	258
094: St. Auto PanningDly (Stereo Auto Panning Delay)	258
095: Tape Echo	259
096: Echo Plus	260
097: Auto Reverse	260
098: Sequence BPM Dly (Sequence BPM Delay)	261
099: L/C/R BPM Delay	261
100: Stereo BPM Delay	262
101: St.BPM Mtap Delay (Stereo BPM Multitap Delay)	263
102: St. BPM Mod. Delay (Stereo BPM Modulation Delay)	264
103: St.BPMAutoPanDly (Stereo BPM Auto Panning Delay)	264
104: Tape Echo BPM	265
105: Reverb Hall	266
106: Reverb Plate	266
107: Reverb Room	267
108: ReverbBrightRoom	267
109: Reverb2 Spring	267
110: Reverb2 Hall	267
111: Reverb2 Plate	267
112: Reverb2 Room	267
113: Early Reflections	268
114: P4EQ - Mt.Delay (Parametric 4-Band EQ - Multitap Delay)	268
115: Comp - Mt.Delay (Compressor - Multitap Delay)	269
116: Limiter - Mt.Delay (Limiter - Multitap Delay)	269
117: Exciter - Mt.Delay (Exciter - Multitap Delay)	270
118: OD/HG - Mt.Delay (Overdrive/Hi.Gain - Multitap Delay)	270
119: Cho/Flng - Mt.Dly (Chorus/Flanger - Multitap Delay)	271
120: Reverb - Gate	271
Double Size effects	273
D00: St.Multiband Limiter (Stereo Multiband Limiter)	273
D01: OD/HyperGain Wah (Overdrive/Hyper Gain Wah)	273
D02: GuitarAmp + P4EQ (Guitar Amp Model + Parametric 4-Band EQ)	274
D03: G.Amp Clean Combo	275
D04: G.Amp California	275
D05: G.AmpTweed	275
D06: G.Amp Modded OD	275
D07: Bass.TubeAmp + Cab (Bass Tube Amp Model + Cabinet)	275
D08: St. Mic + PreAmp (Stereo Mic Modeling + PreAmp)	276
D09: Vocoder	276
D10: Rotary SpeakerOD (Rotary Speaker Overdrive)	277
D11: Multitap Cho/Delay (Multitap Chorus/Delay)	278
D12: St. Pitch Shifter (Stereo Pitch Shifter)	279
D13: Early Reflections	279

Appendices	281
Alternate Modulation Sources (AMS)	281
Alternate Modulation Overview	281
AMS (Alternate Modulation Source) List	282
Alternate Modulation settings	284
Dynamic Modulation Sources (Dmod)	288
Dynamic Modulation Source List	288
SW1/2 Assign	290
Foot Switch Assign	291
Foot Pedal Assign	292
MIDI transmission when the KROSS's controllers are used ..	293
KROSS and MIDI CCs	295
Responses to standard MIDI controllers	295
Parameters controlled by MIDI CCs #70-79	297
MIDI applications	298
About MIDI	298
Settings when connected to a MIDI device or computer	298
Messages transmitted and received by the KROSS	299
File compatibility with the microSTATION	308
MIDI Implementation	309

Program mode

PROG Page Select

Here's how you can select each page.

- Use the PAGE+/- buttons.
- Press the MENU button to access the page menu, use the PAGE+/- buttons to select a page, and press the MENU (OK) button or the ENTER button.
- While the above page menu is displayed, press the FUNCTION (TABS) button, then use the PAGE+/- buttons to select a page by its tab, and then press the MENU (OK) button or the ENTER button.
- Hold down the MENU button and press the PAGE- or PAGE+ buttons.

For details, see “Selecting pages and tabs” on page 11 of the Operation Guide.

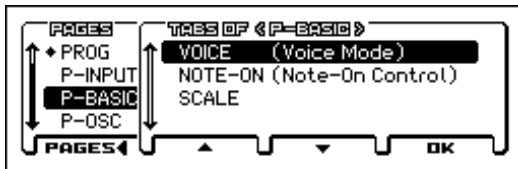

Page	Tabs	Main content
PROG	MAIN	Select and play programs (see page 2)
	TONE	Easy sound editing (see page 3)
	MIXER	OSC1, 2, Drum Track, and step sequencer volume adjustment and mute settings (see page 4)
	ARP	Simple arpeggiator editing (see page 4)
P-INPUT/ CTRL	AUDIO IN	External audio input settings (see page 5)
	CONTROLLERS	SW1 and 2 function assignments (see page 6)
P-BASIC	VOICE	Basic program settings, such as Oscillator mode (see page 7)
	NOTE-ON	Key zone, and timing settings following note-on (see page 8)
	SCALE	Scale settings (see page 10)
P-OSC	MS1...MS4	Multisample and drum kit settings (see page 11)
	VEL	Oscillator velocity zone settings (see page 13)
P-PITCH	BASIC	Oscillator 1 and 2 pitch settings (see page 14)
	MOD	Pitch modulation settings (see page 15)
	PORTA	Portamento settings (see page 17)
P-PITCH EG	ENVELOPE	Pitch EG settings (see page 18)
	L-MOD	Pitch EG level modulation settings (see page 19)
	T-MOD	Pitch EG time modulation settings (see page 20)
P-FILTER	BASIC	Oscillator 1 and 2 filter settings (see page 21)
	MOD	Filter modulation settings (see page 23)
	EG-I	Filter EG intensity settings (see page 24)
	LFO-I	Filter LFO intensity settings (see page 25)
	KTRK	Filter keyboard tracking settings (see page 26)
P-FILTER EG	ENVELOPE	Oscillator 1 and 2 filter EG settings (see page 28)
	L-MOD	Filter EG level modulation settings (see page 29)
	T-MOD	Filter EG time modulation settings (see page 30)
P-AMP	BASIC	Oscillator 1 and 2 amp (volume) and pan settings (see page 32)
	MOD	Amp modulation settings (see page 33)
	KEYTRK	Amp keyboard tracking settings (see page 34)
P-AMP EG	ENVELOPE	Oscillator 1 and 2 amp EG settings (see page 36)
	L-MOD	Amp EG level modulation settings (see page 37)
	T-MOD	Amp EG time modulation settings (see page 38)

Page	Tabs	Main content
P-OSC LFO	1. WAV	Oscillator 1 and 2 LFO1 waveform settings (see page 39)
	1. FRQ	LFO1 frequency and modulation settings (see page 41)
	2. WAV	Oscillator 1 and 2 LFO2 waveform settings (see page 42)
	2. FRQ	LFO2 frequency and modulation settings (see page 42)
P-CMN LFO/ KT	LFO.W	Common LFO waveform settings (see page 42)
	LFO.F	Common LFO frequency and modulation settings (see page 43)
	KT.1	Common keyboard tracking 1 settings (see page 44)
	KT.2	Common keyboard tracking 2 settings (see page 45)
P-AMS MIXER	1	Oscillator 1 and 2 AMS mixer 1 settings (see page 45)
	2	Oscillator 1 and 2 AMS mixer 2 settings (see page 50)
P-ARP	SETUP	Arpeggiator settings (see page 50)
	SCAN ZONE	Arpeggiator trigger region settings (see page 50)
P-DRUM TRACK	PATTERN	Drum Track pattern selection and trigger region settings (see page 50)
	PROGRAM	Drum Track program selection (see page 50)
P-STEP SEQ	BASIC	Step sequencer program selection and length settings (see page 55)
	EDIT	Step on/off entry (see page 56)
	INST	Instrument settings (see page 57)
	MOD	Step sequencer effects such as accent and swing (see page 57)
	MIX	Drum program selection (see page 58)
P-FX ROUTING	BUS	Oscillator 1 and 2 insert effect bus settings (see page 59)
	SEND	Oscillator 1 and 2 master effect send level settings (see page 59)
	IFX	Insert effect type selection and chain settings (see page 60)
	MIXER	Post-insert effect routing settings (see page 61)
P-IFX	IFX1, 2, 3, 4, 5	Insert effect 1-5 settings (see page 61)
P-MFX	SETUP	Master effect type selection and chain settings (see page 62)
	MFX1, 2	Master effect 1 and 2 settings (see page 62)

0: PROG (Program)

This is the main Program mode page. Here you can:

MIDI In the PROG page, MIDI data is transmitted and received on the global MIDI channel that's specified by MIDI Channel (G-MIDI> BASIC). However, MIDI data for the Drum Track and the step sequencer is transmitted and received on the Drum Track Prog MIDI Ch and the Step Seq Prog MIDI Ch (G-MIDI> OUT) respectively.

0-1: MAIN

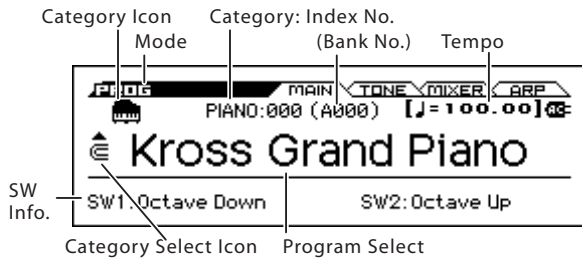

Category Icon [USE/GM, PIANO...DRUM/SFX]

This shows the program's category icon. For the USER category and the GM bank, the icon is shown at the left of the PIANO-DRUM/SFX icon.

Category [PIANO...USER]

This is the program category name.

All programs are organized into 11 preset categories and 1 user category.

PIANO, E.PIANO, ORGAN, BELL, STRINGS, BRASS, SYNTH LEAD, SYNTH PAD, GUITAR, BASS, DRUM/SFX, USER

Index No. (Bank No.) [000... (A...D, U: 0...127, G, g1...g9, gd: 1...128)]

The index number sorts the programs of the A-D, U, and GM banks, starting from number 000.

The index number is the number that is used to transmit or receive MIDI program changes; it ranges from 0-127 for banks A-D and U, and from 1-128 for the GM banks. Of the GM banks g1-g9, programs that have no variation sound are indicated by *, and GM basic sounds will be recalled for these.

Note: Each bank has limitations on saving. (see page 63)

Category Select Icon

Where this icon appears, you can use the sound selector (CATEGORY dial, SELECT dial) to select a program.

Program Select

This is the name of the selected program.

Sound select list

This lists the programs in each category. Select a program and play it. Here's how to access this list and play a program.

1. In the PROG> MAIN page, the list will appear when you turn the CATEGORY dial or SELECT dial, or press the ENTER button.

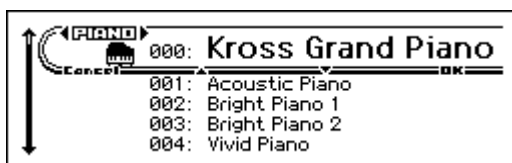

2. If you want to switch to a different category, use the CATEGORY dial or the cursor buttons ◀▶.
3. To select sounds, use the SELECT dial, the value dial, or the cursor buttons ▲▼.
4. If you return to the PROG> MAIN page by pressing the OK (MENU) button, the sound you selected in step 3 will be selected. If you press the Cancel (FUNCTION) button, your selection will be cancelled, and the sound that had been selected before you opened the list will be selected.

Note: To change the category assignment of each program, use the Write Program dialog box.

To switch programs

- Turn the value dial, or use the cursor buttons ▲▼.
- Use the sound selector list (see "Sound select list")
- You can use a foot switch to select programs. (See "Foot Switch Assign" on page 164 and "Foot Switch Assign List" on page 291)
- You can select programs by transmitting a MIDI Program Change from a connected external MIDI device.

Note: MIDI program changes are transmitted using the Bank No. shown in the screen.

♩ (Tempo) [40.00... 300.00, EXT]

This is the tempo for the current Program, which applies to the arpeggiator, drum track, step sequencer, tempo-synced LFOs, and tempo-synced effects.

040.00...300.00: Indicates the tempo

In this page, you can adjust the tempo by turning the TEMPO knob or by pressing the TAP button at the desired interval. In the P-INPUT/CTRL> Controllers page you can enter a numeric value.

EXT is displayed if the **MIDI Clock** (G-MIDI> BASIC) is set to **External MIDI** or **External USB**. This is also shown if the **MIDI Clock** setting is **Auto** and MIDI clock data is being received from an external device. If the tempo source is **EXT**, the arpeggiator etc. will synchronize to MIDI clock data from an external MIDI device.

Battery/AC Icon [AC, BATT, SW]

AC: Indicates that the AC adapter is being used.

BATT, **SW**: Indicates that batteries are being used. The approximate amount remaining is shown.

⚠ If **SW** is flashing, the batteries are almost exhausted. Immediately save any important data, and either install fresh batteries or switch to using the AC adapter.

⚠ If the batteries are exhausted, remove them immediately. Leaving exhausted batteries installed may cause malfunctions such as battery leakage. You should also remove the batteries if you won't be using the unit for an extended period of time.

SW Info.

SW1, SW2: Indicates the functions that are assigned to the SW1 and SW2 buttons.

0-2: TONE (Play Tone Adjust)

PROG	MAIN	TONE	MIXER	ARP
PIANO:000	Kross Grand Piano			
TONE ADJUST	-Cutoff: +00	EG-Attack: +00		
	Resonance: +00	Decay: +00		
	EG Intensity: +00	Sustain: +00		
	Vel.Intensity: +00	Release: +00		

The Tone Adjust function lets you make simple changes to the sound by adjusting the program's main parameters, such as the filter or the filter and amp EG.

Tip: In Combination and Sequencer modes, Tone Adjust also lets you edit Program parameters without the need to save a different version of the original Program. For more information on Tone Adjust in these modes, please see page 75 and 114.

Using and saving the Tone Adjust settings

Your editing will affect the sound immediately, but the values of the original program parameters will not change until you save the program. When you save the program, the result of your Tone Adjust settings will be saved in the program parameters. At that point, all of the Tone Adjust parameter values will be reset to 0.

How parameters and MIDI control changes (CC) affect each other

Most parameters will also affect the parameters that are controlled via MIDI control changes.

Tone Adjust and control changes work independently. For example, you can use the Tone Adjust function to reduce the value of a parameter, and then use a control change to increase it.

The MIDI control change numbers (CC#) corresponding to each Tone Adjust parameter are shown below.

Cutoff: CC#74

Resonance: CC#71

EG Intensity: CC#79

Vel. Intensity: Not supported

Attack: CC#75

Decay: CC#75

Sustain: CC#70

Release: CC#72

See page 297, 303



The compare function is not available for any editing that uses the Tone Adjust parameters.

Category: Index No. , Category Select Icon, Program Select

Select the program.

TONE ADJUST

Cutoff (Filter Cut Off) [-99...+99]

This scales the cutoff frequency of all of the filters at once. It affects both Filters A and B.

Resonance (Filter Resonance) [-99...+99, CC#71]

This scales the resonance of all of the filters at once. It affects both Filters A and B.

EG Intensity (Filter EG Intensity) [-99...+99, CC#79]

This scales the effect of the Filter EG on the cutoff frequency. It affects Filters A and B simultaneously.

If this is set to -99, the filter EG will have no effect. +99 means maximum. Modulation is in the same direction, positive or negative, as the original Program. For instance, if the original Program's EG Intensity was set to -25, then setting the Tone Adjust to +99 moves the EG Intensity to -99.

Vel. Intensity (Amp Velocity Intensity) [-99...+99]

This scales the effect of velocity on the Amp level.

-99 removes the velocity modulation entirely. +99 means maximum modulation in the same direction, positive or negative, as the original Program.

EG

Attack (Filter/Amp EG Attack Time) [-99...+99]

This adjusts the attack time and other related parameters of all filter EGs and amp EGs in a single action.

When the value is +1 or more, this also affects the Amp EG's Start and Attack Levels, Start Level AMS, and Attack Time AMS, as described below:

Between values of +1 and +25, the Start Level, Start Level AMS, and Attack Time AMS will change from their programmed values to 0. Over the same range, the Attack Level will change from its programmed value to 99.

Decay (Filter/Amp EG Decay Time) [-99...+99]

This scales the decay and slope times of the Filter and Amp EGs. It interacts with CC# 75.

Sustain (Filter/Amp EG Sustain Level) [-99...+99]

This scales the sustain levels of the Filter and Amp EGs.

Release (Filter/Amp EG Release Time) [-99...+99]

This scales the release times of the Filter and Amp EGs.

0-3: MIXER (Play Mixer)



Here is where you can adjust the volume of oscillators 1 and 2, the Drum Track and the step sequencer, and mute or solo them. Use the Solo Setting function to turn solo on/off. (see page 63)

Tip: You can use the Hold Balance function to adjust these four volume settings simultaneously. This function is a convenient way to make adjustments while preserving the volume balance.

Category: Index No. , Program Select

Select the program.

OSC1

Play/Mute [Play, Mute]

Play: Oscillator 1 will sound.

Mute: Oscillator 1 will be muted (silent).

Vol (Volume) [000...127]

Adjusts the volume of Oscillator 1.

OSC2

Play/Mute [Play, Mute]

Play: Oscillator 2 will sound.

Mute: Oscillator 2 will be muted (silent).

Note: OSC2 Play/Mute cannot be set for a program whose **Oscillator Mode** is Single or Drums.

Vol (Volume) [000...127]

Adjusts the volume of Oscillator 2.

DRUM TRACK

Play/Mute 1 [Play, Mute]

Play: The drum track will sound.

Mute: The drum track will be muted (silent).

Vol (Volume) [000...127]

Adjusts the volume of the drum track.

STEP SEQ

Play/Mute [Play, Mute]

Play: Step sequencer will sound.

Mute: Step sequencer will be muted (silent).

Vol (Volume) [000...127]

Adjusts the volume of step sequencer.

0-4: ARP (Arpeggiator)



Pattern

This is the easy edit page for the arpeggiator. For more detailed editing, use the P-ARP page.

Category: Index No. , Program Select

Select the program.

MOD (Modulation)

[GATE] [-64...+00...+63]

Specifies the length (gate time) of each note in the arpeggio(see page 51).

[VEL] (VELOCITY) [-64...+00...+63]

Specifies the velocity of the notes in the arpeggio (see page 51).

{SWING} [-64...+00...+63]

This parameter shifts the timing of the odd-numbered notes of the arpeggio (see page 52).

When each MOD parameter is at +00, the effect will be as specified by the Gate, Velocity, and Swing parameters of the P-ARP> SETUP page.

Pattern [Preset: UP...RANDOM, 0000...1027]

Octave [1oct, 2oct, 3oct, 4oct]

Resolution [1/3, 1/2, 2/3, 1, 3/2, 2, 3, 4]

Sort [Off, On]

Latch [Off, On]

Key Sync. [Off, On]

Keyboard [Off, On]

Note: These parameters can also be set from P13: P-ARP (see page 51).

0-1...4: FUNCTION

- 0: **Write Program, Write/Initialize Program** see page 63
- 1: **Solo Setting** see page 63
- 2: **Compare** see page 64
- 3: **Auto Song Setup** see page 64
- 4: **Add to Favorite** see page 64
- 5: **Hold Balance** see page 64 (only MIXER page)
- 6: **Copy Arpeggiator** see page 65 (only ARP page)

For more information, please see the "Program: Function" section on page 63.

1: P-INPUT/CTRLS (Input/Controllers

1-1: AUDIO IN

About the AUDIO IN button

Settings found in this page are active when the front panel AUDIO IN button is on, allowing an external audio signal to be input.



Input Level Meter

G-SET (Use Global Setting)

[Off, On]

On (checked): The general settings in the GLOBAL mode G-INPUT/CTRL page will be used as the external audio input settings. If you want to use the same external input for multiple programs, it is convenient to turn this On (checked) for each program, and make adjustments in GLOBAL mode.

Off (unchecked): The Line or Mic settings you make in this page will be used.

Since this allows you to save external audio input settings that are appropriate for a specific program, it is convenient to use this setting in conjunction with the appropriate audio input settings, for example when you're saving a program as a vocoder effect program. ("Example: Vocoder (Program)" on page 199)

Select

[Line, Mic]

Selects the external input jack that will be used.

Line: LINE IN jack (line level, stereo)

Mic: MIC IN jack (mic level, monaural)

You can adjust the following parameters individually for LINE and MIC.

You can't use the Line input and Mic input simultaneously.

Pan

[L000...L063, C064, R065...R127]

If the Select parameter is set to Mic, this lets you adjust the pan settings of the external audio signal that's being input from the MIC IN jack. C064 pans the sound to the center.

You can't specify this for the Line input. Its stereo panning is fixed.

Input Level Meter

Indicates the level of the external audio that's being input to the KROSS.

If the input is overloaded, the [LINE] or [MIC] indicators in the middle of the level meter will be highlighted. Adjust the Gain of the input stage or the Level parameter that follows the AD converter.

Level

[000...127]

This specifies the level of the external audio signal that's being input. Normally you'll leave this at 127.

The analog audio signal from the LINE IN or MIC IN jack is converted into a digital signal by the AD converter. This Level parameter adjusts the amount of signal immediately after it is converted into digital; if the audio input is distorted, see "Solving distortion caused by input overload."

Solving distortion caused by input overload

If the audio input is too loud, the sound may be distorted.

If the [LINE] or [mic] indication in the Input Level Meter is highlighted, distortion is occurring in the input stage. Adjust the Gain parameter or the volume of your connected device so that this indication is not highlighted.

If there is distortion even though this indication is not highlighted, it may be that an effect of the KROSS is causing the distortion. Adjust the Level parameter to lower the signal level, or adjust the effect settings (such as the Input Trim parameter).

Mute/Play

[Mute, Play]

This specifies whether the external audio input signal will be silenced (muted) or audible.

Mute: The audio input will be silenced (muted).

Play: The audio input will be heard.

Note: Even if this is set to Play, the audio input will not be heard if the AUDIO IN button is off (unlit).

Gain

[00...82, MAX]

This adjusts the level of the external audio input signal at the input stage. See "Solving distortion caused by input overload."

The input gain setting (Gain) is shared by the global setting (G-SET on) and the individual setting (G-SET off). To save the setting, select the setting in Global mode and then use the Write Global Setting function to save it. Although you can edit this in the AUDIO IN page or the QUICK SETTING dialog box of each mode, you can't save it as an individual setting (G-SET off) for a program, combination, or song.

Bus (Bus Select)

[L/R, IFX1...5, Off]

Specifies the output bus for the external audio signal.

L/R: The external audio input signal is output to the L/R bus.

IFX1...5: The external audio input signal is output to the IFX1-5 bus. Use this setting if you want to apply insert effects to the input signal.

Off: The external audio signal is not output to any bus.

Send1

[000...127]

Send2

[000...127]

Specify the send levels where the external audio input signal is sent to the master effects. Use these when you want to apply chorus or delay/reverb to the Mic input sound.

Send1 sends the signal to master effect 1.

Send2 sends the signal to master effect 2.

If **Bus (Bus Select)** is set to IFX1-5, the send levels to the master effects are set by the **Send1** and **Send2** parameters (see page 58) after the signal passes through IFX1-5. (see page 61)

FX Control Bus

[Off, FC1, FC2]

This outputs the external audio input signal to the FX Control bus (stereo two-channel FX Ctrl1, 2). (see page 199)

AUDIO IN – QUICK SETTING

If you hold down the EXIT button and press the AUDIO IN button, the current audio in setting will appear. This is referred to as the audio in quick setting. When a different page is open, this provides a convenient way to quickly access the settings without having to open the AUDIO IN page.

The following illustration shows the case when G-SET is Off.



If G-SET is ON, the GLOBAL setting AUDIO IN is shown and can be edited. When you press the WRITE G-SET (PAGE+) button, the WRITE GLOBAL SETTING dialog box will appear, allowing you to save the setting.



1-2: CONTROLLERS (Controllers Setup)

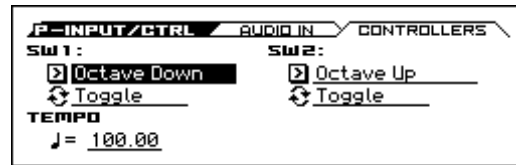

Here you can specify the functions of the front panel SW1 and SW2 buttons, and set the tempo.

SW1

Assign [Off, ..., Pitch Bend Lock]

Selects the function that's used by SW1. This assigns the function of SW1 (see "SW1, SW2 Assign List" on page 290).

Note: If you change the function setting, the status is reset to off.

Note: The on/off status of the SW1, SW2 switches is memorized when you save the program.

Mode [Toggle, Momentary]

This specifies the on/off function when you press the SW1 switch.

Toggle: The state will alternate between On and Off each time you press the SW1 switch.

Momentary: The state will remain On only while you continue holding down the SW1 switch.

SW2

Assign [Off, ..., Pitch Bend Lock]

Mode (SW2 Mode) [Toggle, Momentary]

This assigns the function of SW2. The functions that can be assigned to SW2 are the same as for SW1, with the substitution of SW2 Mod. (CC#81) instead of the SW1's SW1 Mod. (CC#80).

TEMPO

J (Tempo) [40.00... 300.00, EXT]

This is the tempo for the current Program, which applies to the arpeggiator, drum track, step sequencer, tempo-synced LFOs, and tempo-synced effects (see "J (Tempo)" on page 2).

✓ 1-1, 2: FUNCTION

- 0: **Write Program, Write/Initialize Program** see page 63
- 1: **Solo Setting** see page 63
- 2: **Compare** see page 64
- 3: **Auto Song Setup** see page 64
- 4: **Add to Favorite** see page 64

For more information, please see the "Program: Function" section on page 63.

2: P-BASIC

2-1: VOICE (Voice Mode)



Input Level Meter

This page contains all of the basic settings for the Program. Among other things, you can:

- Set up the Program to be a Single, a Double, or a Drum Kit.
- Set the Program to play polyphonically or monophonically.

OSC (Oscillator Mode) [Single, Double, Drums]

Specifies the Program's oscillator assignment; whether it will use one or two oscillators, or a drum kit.

Single: The program will use **one oscillator** (Oscillator 1, Filter 1, Amplifier 1). In this case, the program will normally have a **maximum of 80-note polyphony**.

Double: The program will use **two oscillators** (Oscillator 1/2, Filter 1/2, Amplifier 1/2). In this case the program will normally have a **maximum of 40-note polyphony**.

Drums: The program will use **one oscillator** (as when Single is selected), but Oscillator 1 will be assigned a drum kit instead of a multisample. In this case the program will normally have a **maximum of 80-note polyphony**.

Voice Assign Mode [Poly, Mono]

Select the basic voice allocation mode. Depending on which one you select, various other options will appear, such as **Poly Legato** (Poly mode only) and **Unison** (Mono mode only).

Poly: The program will play polyphonically, allowing you play chords.

Mono: The program will play monophonically, producing only one note at a time.

Poly

These parameters are available when the **Voice Assign Mode** is set to **Poly**.

Legato (Poly Legato) [Off, On]

Legato means to play notes in a smooth and connected manner; the next note is played before the last note is released. This is the opposite of playing detached.

On (checked): When you play a legato phrase, only the first note of that phrase (and within approximately the first 30 msec) will use the normal multisample start point specified by **Start Offset** (P-OSC); all subsequent notes will use the legato start point specified for each multisample.

Note: This is a useful way to simulate the percussive attack of a tonewheel-type organ.

Off (unchecked): Notes will always use the setting of the **Start Offset**, regardless of whether you play legato or detached.

With some Multisamples, **Poly Legato** may not have any effect.

Single Trigger [Off, On]

Single Trigger is available when the **Voice Assign Mode** is set to **Poly**.

On (checked): When you play the same note repeatedly, the previous note will be silenced before the next note is sounded, so that the two do not overlap.

Off (unchecked): When you play the same note repeatedly, the notes will overlap.

MONO

These parameters are available when the **Voice Assign Mode** is set to **Mono**.

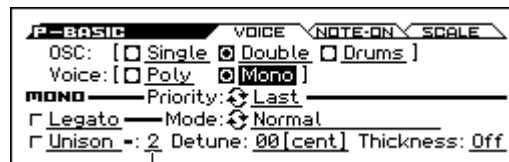

Number of Voices

Legato (Mono Legato) [Off, On]

Legato means to play notes in a smooth and connected manner; the next note is played before the last note is released. This is the opposite of playing detached.

When **Mono Legato** is On, the first note in a legato phrase will sound normally, and then subsequent notes will have a smoother sound, for more gentle transitions between the notes.

The **Mode** parameter, below, switches between two different Mono Legato effects, each of which achieves this smoothness in a different way. See the description of that parameter for more details.

On (checked): When you play with legato phrasing, the notes within a legato phrase will sound smoother, according to the setting of the **Mode** parameter, below.

Off (unchecked): Legato phrasing will produce the same sound as detached playing.

Mode [Normal, Use Legato Offset]

Normal: When you play legato, the multisample, envelopes, and LFOs will not be reset; only the pitch of the oscillator will change. This setting is particularly effective for wind instruments and analog synth sounds.

With this option, the pitch may occasionally be incorrect, depending on which multisample you play, and where on the keyboard you play.

Use Legato Offset: When you play legato, the second and subsequent notes will use the legato start point specified for each multisample, rather than the **Start Offset** (P-OSC) setting.

This is effective when used with a multisample where you've assigned a specific legato offset point. For example, you might use it to control the attack of a breathy, slow-attack sax sound. On some multisamples, this will have no effect.

Envelopes and LFOs will still be reset, as they are with detached playing.

Priority [Low, High, Last]

This parameter determines what happens when more than one note is being held down.

Low: The lowest note will sound. Many vintage, monophonic analog synths work this way

High: The highest note will sound.

Last: The most recently played note will sound.

Unison [On, Off]

On (checked): When Unison is on, the Program uses two or more stacked, detuned voices to create a thick sound.

Use the **Number of Voices** and **Detune** parameters to set the number of voices and amount of detuning, and the **Thickness** parameter to control the character of the detuning.

Off (unchecked): The Program plays normally.

Number of Voices [2...6]

Number of Voices is available when **Unison** is **On**.

This controls the number of detuned voices that will be played for each note when using **Unison**. It applies only when **Unison** is **On**.

Detune [00...99 cents]

Detune is available when **Unison** is **On**.

This parameter sets the tuning spread for the Unison voices, in cents (1/100 of a semitone). The **Thickness** parameter, below, controls how the voices are distributed across the detune amount. When **Thickness** is **Off**, the voices are distributed evenly, centered around the basic pitch.

For instance, let's say that the **Number of voices** parameter is set to **3**, **Detune** is set to **24**, and **Thickness** is **Off**:

Voice one will be detuned down by 12 cents, voice two will not be detuned, and voice three will be detuned up by 12 cents.

Voice	Detune
1	-12
2	0
3	+12

As another example, let's say that **Detune** is still set to **24** and **Thickness** is still **Off**, but the **Number of voices** is set to **4**:

Voice one will still be detuned down by 12 cents, voice two will be detuned down by 4 cents, voice three will be detuned up by 4 cents, and voice 4 will be detuned up by 12 cents.

Voice	Detune
1	-12
2	-4
3	+4
4	+12

Thickness [Off, 01...09]

Thickness is available when **Unison** is **On**.

This parameter controls the character of the detuning for the unison voices.

Off: Unison voices will be evenly distributed across the Detune range, as shown above.

01-09: Unison voices will be detuned in an asymmetric way, increasing the complexity of the detune amount, and changing the way that the different pitches beat against one another. This creates an effect similar to vintage analog synthesizers, where oscillators would frequently drift slightly out of tune. Higher numbers increase the effect.

2-2: Note-On (Note-On Control)

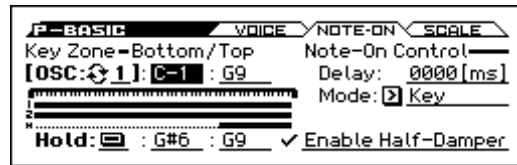

Here you can adjust the following settings.

- Make keyboard split settings for OSC1, OSC2, and Hold.
- Enable/disable the half-damper function.
- Specify the timing of the notes played from the keyboard.

OSC (Oscillator Select) [1, 2]

Select the oscillator (1 or 2) that you want to edit.

Note: Oscillator 2 can be selected if Oscillator Mode is set to Double.

To edit parameters such as the pitch, filter, or amp of oscillator 1 or oscillator 2, use the cursor buttons to select [OSC: 1/2], and use the ENTER button or the VALUE dial to select the oscillator that you want to edit.

Key Zone – Bottom/Top

You can create keyboard splits by setting top and bottom key limits for Oscillators 1 and 2. Also, you can control the keyboard range where the **Hold** parameter takes effect.

Note values and velocity values can also be entered using the keyboard. (see page 12 of the Operation Guide)

Key Zone Bottom [C-1...G9]

This sets the lowest key where the Oscillator will play.

Key Zone Top [C-1...G9]

This sets the highest key where the Oscillator will play.

Zone Graphic

Note-On Control

Delay [0000ms...5000ms, KeyOff]

This specifies the amount of time from when you press a key until the oscillator actually begins to sound.

This is most useful in Double Programs, for delaying one oscillator in relation to the other.

KeyOff is a special setting. Instead of delaying the sound by a particular amount of time, the sound will play as soon as you release the key.

You can use this to produce the “click” sound that is heard each time you release a key of a harpsichord.

In general, when you use the **KeyOff** setting, it's also best to set the oscillator's Amp EG **Sustain Level** to **0**.

Mode [Key, Key + Damper]

Normally, you play notes simply by pressing keys on the keyboard. In special cases, however, you can set this parameter so that you must first be holding down the damper pedal, and then press a key, in order to play a note. For instance, this can be useful when modeling the behavior of a piano soundboard.

Key is the normal mode.

When you select **Key + Damper**, notes will only sound if the damper pedal is being held down. When the damper pedal is released, all notes will be stopped even if they are still being held down.

Hold

Hold [On, Off]

Hold is like permanently pressing down on the sustain pedal. In other words, notes continue to sound as if you were holding down the key - even after you lift your fingers from the keyboard.

Unless the **Sustain Level** is set to **0** in Amp EG 1 (and Amp EG 2 in a Double Program), the sound will play for the entire length of the multisample(s).

On (checked): The **Hold** function is enabled for the range set by the **Hold Bottom** and **Hold Top** parameters, below.

Off (unchecked): Notes will play normally. This is the default setting.

Using Hold with Drum Kits

Hold can be especially useful for drum programs, since it lets the drum samples ring out naturally. In general, when you set the **Oscillator Mode to Drums**, it's good to set **Hold** to **On**.

Once you've turned on **Hold** for a drum program, the function is controlled on a note-by-note basis according to settings within the selected Drum Kit.

If a key's **Enable Note Off Receive** parameter (see page 172) is unchecked, the note will be held.

If the key's **Enable Note Off Receive** parameter is checked, it will not be held.

If you turn off **Hold** in the Program, no keys will be held - regardless of their **Enable Note Off Receive** setting.

Using Hold with Acoustic Pianos

Hold is also useful for simulating the top octaves of an acoustic piano, in where notes always sustain until they fade out naturally, regardless of how long you hold the key.

The **Hold Bottom** and **Hold Top** parameters are designed for exactly this purpose. They let you limit the effect of the Hold parameter to a specific range of the keyboard.

Hold Bottom [C-1...G9]

This sets the lowest key affected by the Hold function.

Hold Top [C-1...G9]

This sets the highest key affected by the Hold function.

Enable Half-Damper [On, Off]

When this is **On** (checked), Half-Damper pedals, normal sustain pedals, and MIDI CC# 64 will all modulate the Amp EG, as described below.

When this is **Off** (un-checked), the pedals and MIDI CC#64 will still hold notes as usual, but will not modulate the Amp EG.

A half-damper pedal is a special type of continuous foot pedal, such as the Korg DS-1H. In comparison to a standard footswitch, half-damper pedals offer more subtle control of sustain, which can be especially useful for piano sounds.

The KROSS will automatically sense when a half-damper is connected to the rear-panel DAMPER input. For proper operation, you will also need to calibrate the pedal, using the **Half Damper Calibration** function in the Global menu.

The off and full-on positions of the half-damper work just like a standard footswitch. In conjunction with the **Enable Half-Damper** parameter, below, intermediate positions allow a graduated control of sustain, similar to the damper pedal of an acoustic piano.

Half-Damper Pedal and Release Time

The amount of modulation depends on whether the Amp EG **Sustain Level** is set to **0** (as is the case with most acoustic piano sounds), or set to **1** or more. The modulation is continuous, from 1x (no change) to 55 times longer; the table below shows a selection of representative points.

Half-Damper modulation of Amp EG Release Time

CC#64 Value	Multiply Amp EG Release Time by...	
	If Sustain = 0	If Sustain = 1 or more
0	1x	1x
32	2.1x	2.1x
64	3.2x	3.2x
80	5.9x	
96	22.3x	
127	55x	

2-3: SCALE



Selects the basic scale for the Program.

Scale Type [Equal Temperament...User Octave 15]

Selects the basic scale.

Note that for many of the scales, the setting of the **Key** parameter, below, is very important.

Equal Temperament: This is the most widely used scale by far, in which each semitone step is spaced at equal pitch intervals.

Equal Temperament allows easy modulation, so that a chord progression played in the key of C sounds roughly the same as the same progression played in F#. Sacrificed, however, is some of the purity of individual intervals offered by the scales below.

Pure Major: In this temperament, major chords of the selected key will be perfectly in tune.

Pure Minor: In this temperament, minor chords of the selected key will be perfectly in tune.

Arabic: This scale includes the quarter-tone intervals used in Arabic music.

Pythagoras: This scale is based on ancient Greek music theory, and is especially effective for playing melodies. It produces completely pure fifths, with one exception, at the expense of detuning other intervals— thirds in particular.

As much as Pythagoras might have liked to do so, it's not possible to make all the fifths pure while also keeping the octave in tune. For the sake of the octave, one of the fifths, the interval from the sharp fourth degree to the sharp first degree is made quite flat.

Werkmeister (Werkmeister III): This scale was one of the many temperament systems developed towards the end of the Baroque period. These "Well-Tempered" tunings were aimed at allowing relatively free transposition although you'll still notice that the different keys maintain their own distinct characteristics, unlike Equal Temperament.

J.S. Bach was referring to these new scales in his title, "The Well-Tempered Clavier." As such, this group are particularly appropriate for late baroque organ and harpsichord music.

Kirnberger (Kirnberger III): This is a second "Well-Tempered" tuning, dating from the early 18th century.

Slendro: This is an Indonesian gamelan scale, with five notes per octave.

When **Key** is set to C, use the C, D, F, G and A notes. Other keys will play the normal equal-tempered pitches.

Pelog: This is another Indonesian gamelan scale, with seven notes per octave.

When **Key** is set to C, use the white keys. The black keys will play the equal tempered pitches.

Stretch: This tuning is used for acoustic pianos.

User All Notes Scale: This is a user-programmed scale with different settings for all 128 MIDI notes. You can set up this scale in Global mode (G-USER SCALE> ALL).

User Octave Scale 00-15: These are user-programmed scales with settings for each of the 12 notes in an octave. You can set them up in Global mode (G-USER SCALE> OCTAVE).

Key (Scale Key)

[C...B]

Selects the key of the specified scale.

This setting does not apply to the **Equal Temperament**, **Stretch**, and **User All Notes** scales.

⚠ If you're using a scale other than Equal Temperament, the combination of the selected scale and the **Key** setting may skew the tuning of the note. For example, A above middle C might become 442 Hz, instead of the normal 440 Hz. You can use the Global Mode's **Master Tune** (GLOBAL> BASIC) parameter to correct this, if necessary.

Random

[0...7]

This parameter creates random variations in pitch for each note. At the default value of 0, pitch will be completely stable; higher values create more randomization.

This parameter is handy for simulating instruments that have natural pitch instabilities, such as analog synths, tape-mechanism organs or acoustic instruments.

✓ 2-1: FUNCTION

- 0: **Write Program, Write/Initialize Program** see page 63
- 1: **Solo Setting** see page 63
- 2: **Compare** see page 64
- 3: **Auto Song Setup** see page 64
- 4: **Add to Favorite** see page 64
- 5: **Copy Oscillator** see page 64
- 6: **Swap Oscillator** see page 64

For more information, please see the "Program: Function" section on page 63.

3: P-OSC

These pages control the first and most basic elements of sounds: the Multisamples that the oscillators play, and the pitch where it plays them. For instance, you can:

- Select Multisamples for Single and Double Programs, or Drum Kits for Drum Program.
- Set up velocity splits, crossfades, and layers for Single and Double Programs.
- Set the basic pitch of the sound, including the octave, transpose, and so on.

Note that when the **Oscillator Mode** is set to **Single** or **Drums**, only Oscillator 1's filters are active; the pages for Oscillator 2's filters will be grayed out.

Multisamples, and Drum Kits

Multisamples and Drum Kits allow you to play samples in different ways.

- Multisamples lay out one or more samples across the keyboard. For instance, a very simple guitar Multisample might have six samples one for each string.
- As the name suggests, Drum Kits are optimized for playing drum samples.

Velocity splits, crossfades, and layers

Each oscillator has eight velocity zones that allow different keyboard velocities to switch the multisample or drum sample that is actually sounded.

For each zone, you can specify the threshold (boundary value) and crossfade (how velocity will smoothly fade between the samples of adjacent zones). This allows you to create velocity-switched or layered sounds, such as the following examples.

- Velocity splits where the zones are cleanly separated at their threshold
- Velocity crossfades where the zones will smoothly crossfade beyond their threshold.
- Velocity layers where additional sounds are added for a velocity region above a specified threshold.

Note: If the **Oscillator Mode** is Drums, the velocity zone settings already specified for the drum kit will be applied, and will not be shown on the screen. The velocity zones for a drum kit can be edited in Global Drum Kit (see page 169).

3-1: MS 1 (Multisample 1)

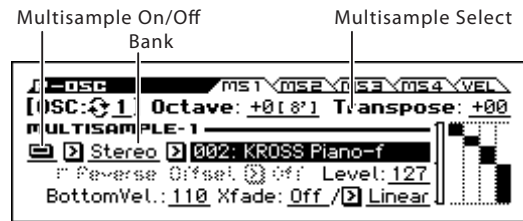

Program's sounds are based on multisamples, and this page lets you set up all of the basic multisample-related settings. Among other things, you can:

- Select Multisamples for the Oscillator (in a Single or Double Program), or select the Drum Kit for a Drum Program
- Set the Oscillator's basic pitch
- Set up velocity switching, crossfades, and layers for multisamples.

OSC (Oscillator Select) [1, 2]

Select the oscillator (1 or 2) that you want to edit.

Note: Oscillator 2 can be selected if Oscillator Mode is set to Double.

Octave [-2[32'], -1[16'], +0[8'], +1[4']]

This sets the basic pitch of the Oscillator, in octaves. The default is +0[8']. The standard octave of a multisample is +0 [8'].

Transpose [-12...+12]

This adjusts the pitch in semitones, over a range of ± 1 octave.

MULTISAMPLE-1

If you want to create a simple setup with only a single Multisample, just set up Multisample1 as desired, and then set the **Threshold Velocity** to 1 and the **Crossfade (Crossfade Range)** to Off.

Multisample On/Off [Off, On]

Specifies whether multisample 1 will sound.

It will sound if this is On.

Bank [Mono, Stereo]

This is displayed if **Multisample On/Off** is On.

You can choose between looking at mono and stereo Multisamples.

Mono, Stereo: Conventional monaural or stereo multisamples.

Note that stereo Multisamples will require twice as many voices as mono Multisamples.

Multisample select [List of Multisample]

This specifies a multisample.

 Some multisamples have an upper limit; notes played above that limit will not sound.

Use the Multisample Select popup button to open the multisample list. You can choose a multisample from the list.

Use the cursor buttons \blacktriangleleft \blacktriangleright to select a category, use the cursor buttons \blacktriangleup \blacktriangledown to select a multisample within that category, and press the ENTER button to confirm your choice. If you press cursor buttons \blacktriangleleft \blacktriangleright simultaneously, the first multisample in the selected category will be selected. An " \blackrightarrow " symbol is shown to the left of the first multisample.

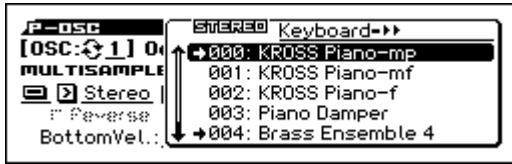

Reverse [Off, On]

This plays the selected multisample in reverse without looping it.
Note: If an individual sample within the multisample is already set to reverse, it will play in reverse without this setting.

On (checked): The multisample will play in reverse.
Off (unchecked): The multisample will play normally.

⚠ For some multisamples, this setting is not available.

Offset (Start Offset) [Off, 1st...4th]

In addition to simply starting playback from the beginning, Multisamples can have up to 4 different pre-programmed alternate starting points.

The **Start Offset** option specifies whether to use the normal start point (**Off**), or to use one of the alternate start points (**1st-4th**).

Some Multisamples may have fewer than 4 pre-programmed points, in which case only the available points can be selected.

Level [000...127]

This sets the basic volume level of the multisample. The Amp section can modify this basic level extensively with envelopes, LFOs, keyboard tracking, and other modulation; for more information, please see “8: P-Amp” on page 32.

⚠ Depending on the multisample, high **Level** settings may cause distortion when playing many notes at a time. If this occurs, lower the **Level**.

Bottom Vel. (Bottom Velocity) [001...127]

This sets the lowest velocity where the Multisample will sound. Multisample1’s **Bottom Vel.** can be equal to, but not lower than, that of Multisample2.

Xfade (Crossfade Range) [Off, 001...127]

This sets the range of velocities where Multisample1 will fade into Multisample2, going up from the **Bottom Vel.**

For instance, if the **Bottom Vel.** is set to 64, and the **Xfade** is set to 20, MS2 will start to fade in at velocities of 84 and below.

When velocities are within the **Xfade**, the Oscillator will use twice as much polyphony as it would normally.

Note: You can only fade between two zones at once.

This shows the velocity zone.

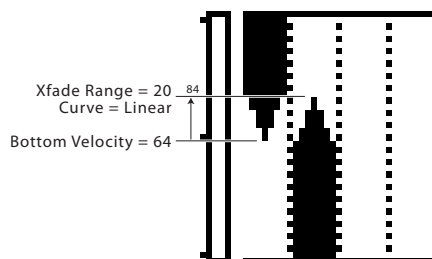

Curve [Linear, Power, Layer]

This controls the volume curve of the crossfade. **Linear** and **Power** (short for Equal Power) let you fine-tune the way that the two Multisamples mix together; one or the other may be more appropriate for a given pair of Multisamples. **Layer**, true to its name, lets you layer the two Multisamples together without any crossfading.

Linear means that the two samples will each be at 50% of their full volume in the middle of the crossfade. Sometimes, this may create a dip in the volume level; if so, try using **Power** instead.

Power, short for Equal Power, means that the two samples will each be at around 70% of their full volume in the middle of the crossfade. Sometimes, this may create a bump in the volume level, in which case you might try selecting **Linear** instead.

Layer means that the two Multisamples will be layered together, both at full volume, for the entire range of the crossfade.

Crossfade Curves

Linear

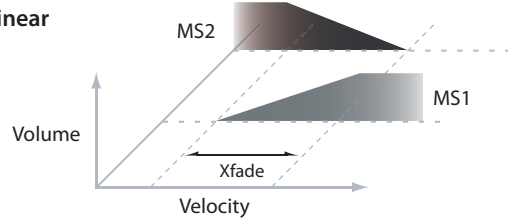

Power

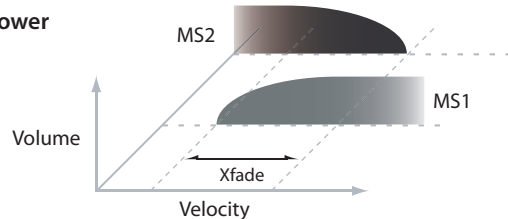

Layer

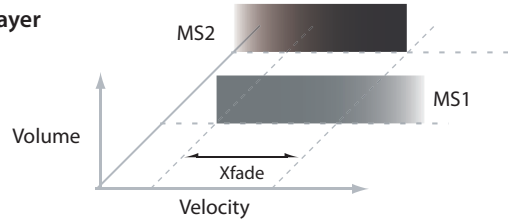

Velocity Split

This shows the velocity zones for the oscillator’s four multisamples and for each oscillator.

The meter on the left indicates the note-on velocity. This allows you to verify the multisamples that will sound at each velocity.

Oscillator Mode Drums

This parameter appears when the **Oscillator Mode** is set to Drums or Double Drums.



Drum Kit [000...031 (INT), 032...047 (USER), 048...056 (GM)]

This selects a drum kit.

3-2: MS 2 (Multisample 2)

3-3: MS 3 (Multisample 3)

3-4: MS 4 (Multisample 4)

These are the multisample settings for Multisamples 2-4. The parameters for Multisample 2 and 3 are exactly the same as those for Multisample 1.

The parameters for Multisample 4 are also similar to those for Multisample 1, except that Multisample 4 has no settings for **Bottom Vel. (Bottom Velocity)** (which is always fixed at 1) and **Xfade (Crossfade Range)**.

3-5: VEL (Velocity Zone)

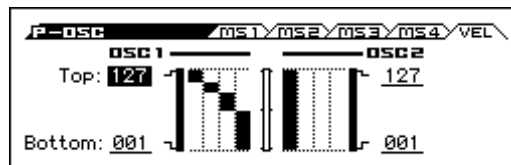

Here you can adjust the velocity zone for oscillators.

OSC1

Velocity can be used to switch between sounding oscillators 1 and 2. Here you can specify the velocity zone for oscillator 1.

This velocity zone setting takes priority over the velocity settings of multisamples 1-8. The status of the settings is indicated by the graph on the right side of the screen. This lets you adjust settings while comparing them with the velocity split graph.

Top [001...127]

This sets the highest velocity where the Oscillator 1 will sound.

Note: The **OSC1 Top** velocity must be greater than the **OSC1 Bottom** velocity.

Bottom [001...127]

This sets the lowest velocity where the Oscillator 1 will sound.

Tips: You can also set the note value and velocity value by the keyboard (see page 12 of the Operation Guide).

OSC2

Top [001...127]

This sets the highest velocity where the Oscillator 1 will sound.

Note: The **OSC1 Top** velocity must be greater than the **OSC1 Bottom** velocity.

Bottom [001...127]

This sets the lowest velocity where the Oscillator 1 will sound.

Tips: You can also set the note value and velocity value by the keyboard (see page 12 of the Operation Guide).

Oscillator Mode Drums

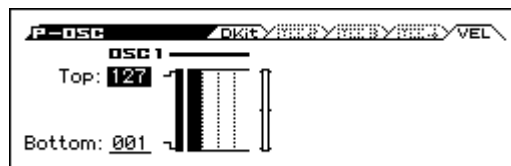

Here you can specify the velocity zone for oscillator 1.

Top [001...127]

This sets the highest velocity where the Oscillator 1 will sound.

Note: The **Top** velocity must be greater than the **Bottom** velocity.

Tips: You can also set the note value and velocity value by the keyboard (see page 12 of the Operation Guide).

Bottom [001...127]

This sets the lowest velocity where the Oscillator 1 will sound.

✓ 3-1...5: FUNCTION

- 0: Write Program, Write/Initialize Program see page 63
- 1: Solo Setting see page 63
- 2: Compare see page 64
- 3: Auto Song Setup see page 64
- 4: Add to Favorite see page 64
- 5: Copy Oscillator see page 64
- 6: Swap Oscillator see page 64

For more information, please see the “Program: Function” section on page 63.

4: P-PITCH

This page contains all of the settings for Oscillator 1’s pitch modulation.

4-1: BASIC

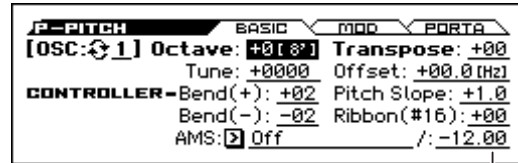

AMS Intensity

Here, you can:

- Specify pitch bend being controlled by the pitch bend wheel (or an incoming pitch bend message) set to independent Bend Up and Bend Down, or controlled by an incoming message CC#16 (the ribbon control message etc).
- Use Pitch Slope to control how the pitch changes when you play up and down the keyboard.
- Assign AMS modulation for pitch.

OSC (Oscillator Select) [1, 2]

Select the oscillator (1 or 2) that you want to edit.

Note: Oscillator 2 can be selected if Oscillator Mode is set to Double.

Octave [-2[32'], -1[16'], +0[8'], +1[4']]

This sets the basic pitch of the Oscillator, in octaves. The default is +0[8']. The standard octave of a multisample is +0 [8'].

Transpose [-12...+12]

This adjusts the pitch in semitones, over a range of ±1 octave.

Tune [-1200...+1200]

This adjusts the pitch in cents, over a range of ±1 octave. A cent is 1/100 of a semitone.

Offset (Frequency Offset) [-10.0Hz ... +10Hz]

This adjusts the pitch by increments of 0.1 Hz. **Frequency Offset** is different from **Tune** in that, when used to detune the two oscillators, it can create a constant beat frequency across the range of the keyboard.

CONTROLLERS

Bend (+) [-60...+12]

Specifies the amount of pitch change in semitone units that occurs when you move the pitch bend wheel away from yourself (or when a pitch bend message with a value of 1 or higher is received). For normal pitch bend, set this to a positive value.

For example with a setting of +12, moving the pitch bend wheel away from yourself will raise the pitch of the notes you’ve played, by up to one octave.

Bend (-) [-60...+12]

Specifies the amount of pitch change in semitone units that occurs when you move the pitch bend wheel toward yourself (or when a pitch bend message with a value of -1 or lower is received). For normal pitch bend, set this to a negative value.

For example with a setting of -60, moving the pitch bend wheel toward yourself will lower the pitch of the notes you've played, by up to five octaves.

Pitch Slope [-1.0...+2.0]

Normally, this should be set to the default of +1.0.

Pitch Slope, pitch, and note

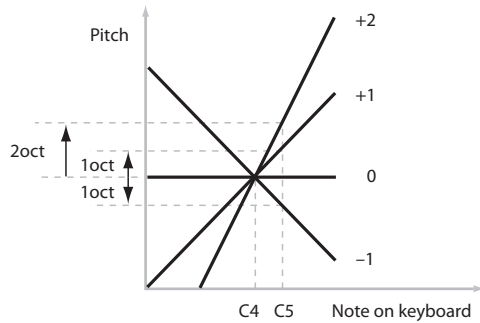

Positive (+) values cause the pitch to rise as you play higher on the keyboard, and **negative (-)** values cause the pitch to fall as you play higher on the keyboard.

When this is set to **0**, playing different notes on the keyboard won't change the pitch at all; it will be as if you're always playing C4. This can be useful for special effects sounds, for instance.

Ribbon (#16) [-12...+12]

Specify in semitones how the pitch will change when CC#16 is received.

With a positive (+) setting, the pitch will rise when the value of CC#16 is higher than the center value of 64. With a negative (-) setting, the pitch will fall.

AMS (Pitch) [List of AMS Sources]

This selects an AMS source to control the pitch. For a list of AMS sources, please see "AMS (Alternate Modulation Source) List" on page 282.

Intensity [-12.00...+12.00]

This controls the depth and direction of the pitch modulation, in semitones.

For example if you set **AMS (Pitch)** to **M.Wheel #01** and then move the modulation wheel away from yourself, the pitch will rise if this parameter is set to a **positive (+)** value, or fall if this parameter is set to a **negative (-)** value.

4-2: MOD (Modulation)

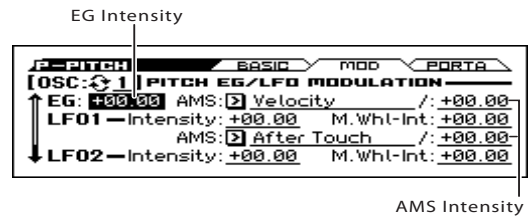

You can set up initial amounts of pitch modulation from the Pitch EG and LFO1/2, as well as AMS modulation of LFO and EG amounts.

OSC (Oscillator Select) [1, 2]

Select the oscillator (1 or 2) that you want to edit.

Note: Oscillator 2 can be selected if Oscillator Mode is set to Double.

EG

EG Intensity [-12.00...+12.00]

This controls the initial effect of the Pitch EG on Oscillator 1's frequency, in half-steps, before any AMS modulation.

The Pitch EG's shape can swing all the way from +99 to -99. When the **Intensity** is set to a **positive (+)** value, positive values from the EG raise the pitch, and negative values lower the pitch.

When the **Intensity** is set to a **negative (-)** value, the effect of the EG is reversed; positive EG values mean lower pitches, and negative EG values mean higher pitches.

AMS (Pitch EG) [List of AMS Sources]

This selects any AMS modulation source to scale the amount of the Pitch EG.

For a list of AMS sources, please see "AMS (Alternate Modulation Source) List" on page 282.

AMS Intensity [-12.00...+12.00]

This controls the depth and direction of the pitch EG AMS modulation. The AMS modulation and the initial Intensity are added together to determine the Pitch EG's final effect.

With **positive (+) values**, greater modulation will increase the effect of the Pitch EG, as shown in example **B** below.

With **negative (-) values**, greater modulation will introduce the opposite effect of the Pitch EG—like inverting the polarity of the envelope. You can use this in several different ways:

- You can set an initial positive amount with the Intensity parameter, and then reduce this amount with AMS. In this case, the final effect of the EG is simply diminished, and not actually inverted, as shown in example **C**.
- You can also set the AMS Intensity amount to be greater than the initial Intensity. In this case, the EG will have a positive effect with low modulation amounts, and an inverted effect at higher modulation amounts as shown in example **D**.

Pitch EG AMS

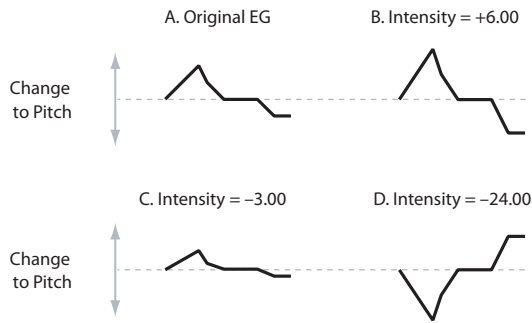

LFO1 Int., **M.Whl-Int**, and **AMS (LFO1)** settings are summed to determine the depth and direction of pitch modulation produced by OSC1 LFO1.

LFO2

The parameters for LFO2 are identical to those for LFO1. For more information, please see the descriptions under LFO1, above.

LFO1

LFO1 and LFO2 can both control the pitch. You can control the strength of each LFO's modulation in three different ways:

- Set an initial amount of LFO modulation, using the **LFO1 Int.**, **LFO2 Int.** parameters.
- Use **M.Whl-Int** to adjust the amount of LFO that is applied when you use the modulation wheel.
- Use any AMS source to scale the amount of the LFO.

The results are added together to produce the total LFO effect.

LFO1 Intensity **[-12.00...+12.00]**

This controls the initial effect of the LFO on the pitch, in semitones, before any **M.Whl-Int** or AMS modulation.

Negative (-) settings will invert the phase of the LFO.

M.Whl-Int (Modulation Wheel Intensity) **[-12.00...+12.00]**

Specify the depth of pitch modulation produced by OSC1 LFO1 when the modulation wheel is moved away from yourself (or when CC#1 is received).

This parameter sets the maximum amount of LFO modulation added by **M.Whl-Int**, in semitones.

As this value is **increased**, moving the modulation wheel away from yourself will cause the OSC1 LFO1 to produce deeper pitch modulation.

Negative (-) settings will invert the phase of the LFO. You can also use this to reduce the initial amount of the LFO, as set by **LFO1 Int.**, above.

For example:

1. **Set LFO1 Int. to +7.00.**

The LFO will now have a fairly strong effect on the pitch, bending it by a perfect 5th.

2. **Set M.Whl-Int to -7.00.**

Moving the modulation wheel away from yourself will decrease the effect of the LFO. If you move the wheel all the way, the LFO will be cancelled, and no modulation will be applied.

AMS (LFO1) **[List of AMS Sources]**

This selects any AMS modulation source to scale the amount of the LFO applied to pitch.

For a list of AMS sources, please see "AMS (Alternate Modulation Source) List" on page 282.

AMS Intensity **[-12.00...+12.00]**

This controls the depth and direction of the **AMS (LFO1)** modulation for pitch.

With a setting of **0**, modulation will not be applied. With a setting of **12.00**, the OSC1 LFO1 will apply a maximum of +/-1 octave of pitch modulation.

For example if you play the keyboard with AMS (LFO1) set to Filter EG, pitch modulation will be stronger when the Filter envelope value is higher. If this has a positive ("+") value, pitch modulation via OSC1 LFO1 is applied at normal phase; if it has a negative ("-") value, the phase is inverted.

4-3: PORTA (Portamento)

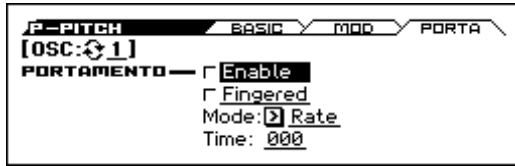

Here you can set up Portamento.

OSC (Oscillator Select) [1, 2]

Select the oscillator (1 or 2) that you want to edit.

Note: Oscillator 2 can be selected if Oscillator Mode is set to Double.

PORTAMENTO

Portamento lets the pitch glide smoothly between notes, instead of changing abruptly.

Enable [Off, On]

On (checked): Turns on Portamento, so that pitch glides smoothly between notes.

Off (unchecked): Turns off Portamento. This is the default state.

Fingered [Off, On]

This parameter allows you to control Portamento through your playing style. When it's enabled, playing legato will turn on Portamento, and playing detached will turn it off again.

This option is only available when Portamento **Enable** is turned on.

On (checked): Turns on Fingered Portamento.

Off (unchecked): Turns off Fingered Portamento.

Mode [Rate, Time]

Rate means that Portamento will always take the same amount of time to glide a given distance in pitch - for instance, one second per octave. Put another way, gliding several octaves will take much longer than gliding a half-step.

Time means that Portamento will always take the same amount of time to glide from one note to another, regardless of the difference in pitch. This is especially useful when playing chords, since it ensures that each note in the chord will end its glide at the same time.

Time [000...127]

This controls the portamento time. Higher values mean longer times, for slower changes in pitch.

This option is only available when Portamento **Enable** is turned on.

Assigning SW1 or SW2 to Portamento On/Off

You can turn portamento on/off by using the two assignable switches SW1 and SW2.

To do so:

1. Go to the **P-INPUT/CTRL>CONTROLLERS** page.
2. Under **Panel Switch Assign**, set either SW1 or SW2 to **Porta.SW (CC#65)**.

Now, the selected switch will enable and disable Portamento.

MIDI If you assign portamento to SW1/2, MIDI portamento controller #65 will be transmitted each time you use the switch. You can also turn portamento on/off by receiving MIDI controller #65.

4-1...3: FUNCTION

- 0: **Write Program, Write/Initialize Program** see page 63
- 1: **Solo Setting** see page 63
- 2: **Compare** see page 64
- 3: **Auto Song Setup** see page 64
- 4: **Add to Favorite** see page 64
- 5: **Copy Oscillator** see page 64
- 6: **Swap Oscillator** see page 64

For more information, please see the "Program: Function" section on page 63.

5: P-PITCH EG (Pitch Envelope) AMSource

The Pitch EG, or Envelope Generator, lets you create complex, time-varying changes to the pitch of Oscillators 1 and 2. The parameters on this page control the shape of the EG. For instance, you can:

- Create the basic EG shape by setting the levels and times of each segment.
- Control the curvature of each EG segment, for subtle control over the modulation time of the EG.
- Set up complex modulation of EG levels and times.
- Set up an AMS source, such as an LFO, to restart the EG.

To control how much effect the EG has on the pitch, use the Pitch EG parameters on the P-PITCH>MOD page, as described under “4-2: MOD (Modulation)” on page 15.

Differences from the other EGs

The Pitch EG is different from the Filter and Amp EGs in several ways:

- The single Pitch EG is shared by both Oscillator 1 and Oscillator 2.
- The Sustain level is always 0.
- The Level modulation has two AMS sources instead of one, and the Time modulation has one AMS source instead of three.

Pitch EG is also an AMS source

You can use the Pitch EG as an AMS source to modulate other parameters, just like the keyboard tracking and LFOs. Simply select the Pitch EG in the AMS list for the desired parameter.

5-1: ENVELOPE

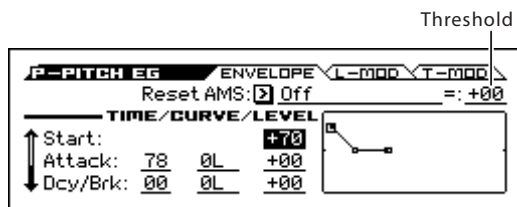

Reset AMS (EG Reset AMS)

[List of AMS Sources]

This selects an AMS source to reset the EG to the start point. For instance, you can use a tempo-synced LFO to trigger the EG in a repeating rhythm. This reset is in addition to the initial note-on, which always causes the EG to start.

For a list of AMS sources, please see “AMS (Alternate Modulation Source) List” on page 282.

Threshold

[-99...+99]

This sets the AMS level which will trigger the EG reset. Among other things, you can use this to adjust the exact point in an LFO’s phase where the EG will be reset, effectively controlling its “groove” against other rhythmic effects.

When the threshold is **positive**, the EG triggers when passing through the threshold moving upwards. When the threshold is **negative**, the EG triggers when passing through the threshold moving downwards.

Note: For several LFO waveform types, or if the LFO cycle is fast, the LFO output may not always keep up with high values such as +99 or -99.

TIME/CURVE/LEVEL

Pitch EG

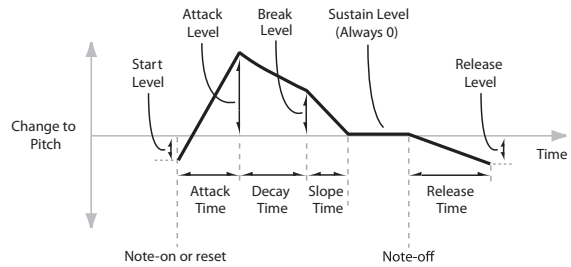

The envelope moves to a specified level over the specified time, and then moves to the next specified level over the specified time. It produces a modulation signal corresponding to this movement.

The parameters below let you set four levels, the amount of time it takes to go from each of the levels to the next, and the shape (from linear to curved) of each transition.

Time

Higher values mean longer times, as shown below:

EG Value	Actual Time
10	10 ms
20	44 ms
30	104 ms
40	224 ms
50	464 ms
60	944 ms
70	1.8 seconds
80	3.8 seconds
90	10.9 seconds
99	87.3 seconds

Attack

[00...99]

This sets how long the EG takes to move from the Start level to the Attack level.

For the fastest possible attack time, you can set the Start level to +99; in this case, the EG will start instantaneously at its maximum value.

Dcy/Brk (Decay)

[00...99]

This sets the time it takes to move from the Attack level to the Break level.

Slope

[00...99]

This sets how long the EG takes to move from the Break level to the Sustain level (which for the Pitch EG is always 0). Once it reaches the Sustain level, the EG will stay there until note-off, unless it is reset via AMS.

Release

[00...99]

This sets how long it takes the EG to move from the Sustain level to the Release level.

Curve

For the sake of simplicity, most of the diagrams in this manual show envelopes as being made out of straight lines. In actuality, though, envelopes are more likely to be made out of curves.

In other words, each segment’s level will change quickly at first, and then slow down as it approaches the next point. This tends to sound better than straight, linear segments.

Classic analog synth envelopes made these curved shapes naturally. The KROSS goes a step further than vintage synths, however, and lets you control the amount of curvature separately for each of the four envelope segments.

Pitch EG Curve

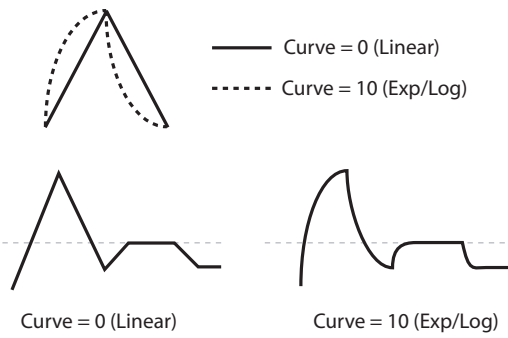

When you change the curvature, the EG times remain the same. However, greater curvature will tend to sound faster, because the value changes more quickly at the beginning.

Different curve settings for up and down

You may find that different amounts of curvature are suitable for segments which go up and segments which go down.

For instance, a curve of 3 is a good default setting for upward segments, such as Attack. On the other hand, a curve of 6 or more is good for downward segments, such as Decay and Release.

Attack [0L (Linear), 1...9, 10E (Exp/Log)]

This sets the curvature of the Attack segment - the transition from the Start level to the Attack level.

Dcy/Brk (Decay) [0L (Linear), 1...9, 10E (Exp/Log)]

This sets the curvature of the Decay segment - the transition from the Attack level to the Break level.

Slope [0L (Linear), 1...9, 10E (Exp/Log)]

This sets the curvature of the Slope segment - the transition from the Break level to the Sustain level (which for the Pitch EG is always 0).

Release [0L (Linear), 1...9, 10E (Exp/Log)]

This sets the curvature of the Release segment - the transition from the Sustain level to the Release level.

Level

Each of the four levels can be either positive or negative.

Positive levels will make the pitch (or other AMS destination) go up from its programmed value; **negative** levels will make it go down.

Note that, unlike the Filter and Amp EGs, the Pitch EG's Sustain Level is always 0.

Start [-99...+99]

This sets the initial level at note-on.

Attack [-99...+99]

This sets the level at the end of the Attack time.

Dcy/Brk (Break) [-99...+99]

Break, short for Break Point, sets the level at the end of the Decay time.

Release [-99...+99]

This sets the level at the end of the Release time.

5-2: L-MOD (Level Modulation)

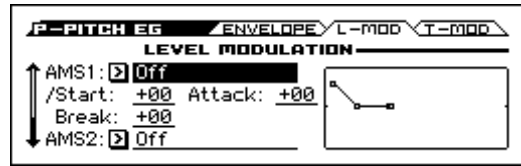

These settings let you use two different AMS sources to control the Level parameters of the EG. For each of the two AMS sources, the Start, Attack, Decay, and Break levels each have their own modulation intensities.

By using different settings for each of the three levels, you can cause both subtle and dramatic changes to the EG shape, as shown below.

Note: Once the EG has started a segment between two points, that segment can no longer be modulated. This includes both the time of the segment, and the level reached at the end of the segment.

For instance, if the EG is in the middle of the Decay time, you can no longer modulate either the Decay time or the Break level.

This also means that modulating the Start level, Attack level, or Attack time will not affect notes that are already sounding, unless the EG is then re-started via EG Reset.

Pitch EG Level Modulation

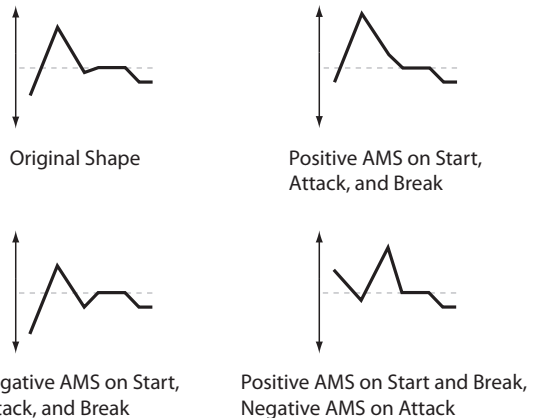

AMS1

AMS1 [List of AMS Sources]

This selects the first AMS source to control the EG's Level parameters.

For a list of AMS sources, please see "AMS (Alternate Modulation Source) List" on page 282.

Start [-99...+99]

This controls the depth and direction of the AMS modulation for the Start level.

For example, if you set the AMS1 source to Velocity and set St to +99, the Start level will increase as you play harder. If you instead set St to -99, the Start level will decrease as you play harder.

Attack [-99...+99]

This controls the depth and direction of the AMS modulation for the Attack level.

Break [-99...+99]

This controls the depth and direction of the AMS modulation for the Break level.

AMS2

This selects the second AMS source for controlling the EG's Level parameters. The parameters of AMS2 are identical to those of AMS1, above.

5-3: T-MOD (Time Modulation)

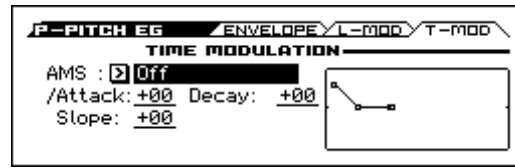

These settings let you use an AMS source to control the Time parameters of the EG. The Attack, Decay, and Slope times share this AMS source, but each has its own modulation intensity.

Pitch EG Time Modulation

AMS=Velocity, Intensity = a positive (+) value

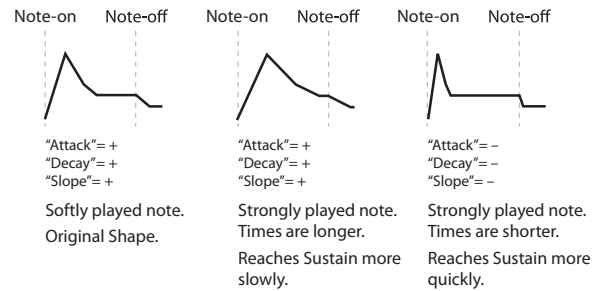

AMS1

AMS

[List of AMS Sources]

This selects the AMS source to control the EG's Time parameters. Velocity and Keyboard Track can both be useful here for instance.

For a list of AMS sources, please see "AMS (Alternate Modulation Source) List" on page 282.

Attack

[-99...+99]

This controls the depth and direction of the AMS modulation for the Attack time.

For example, if you set the **AMS** source to Velocity and set **Attack** to +99, the Attack time will get much longer at higher velocities. If you instead set **Attack** to -99, the Attack time will get much shorter at higher velocities.

When the AMS source is at its maximum value for instance, when **Velocity** is at 127 a setting of +8 will make the Attack time almost twice as long, and a setting of -8 will cut the Attack time almost in half.

Decay

[-99...+99]

This controls the depth and direction of the AMS modulation for the Decay time.

Slope

[-99...+99]

This controls the depth and direction of the AMS modulation for the Slope time.

5-1...3: FUNCTION

- 0: **Write Program, Write/Initialize Program** see page 63
- 1: **Solo Setting** see page 63
- 2: **Compare** see page 64
- 3: **Auto Song Setup** see page 64
- 4: **Add to Favorite** see page 64
- 5: **Copy Oscillator** see page 64
- 6: **Swap Oscillator** see page 64

For more information, please see the "Program: Function" section on page 63.

6: P-FILTER

Filtering can make subtle or dramatic changes to the oscillator's timbre. Each oscillator has two multimode resonant filters, A and B, as well as a dedicated filter envelope and keyboard tracking generator.

These pages let you control all aspects of the filters. Among other things, you can:

- Adjust basic settings for each oscillator's filters, including routing, modes, cutoff, resonance, etc.
- Set up filter modulation, including keyboard tracking, the filter envelope, LFO modulation, and AMS control.

Note that when the **Oscillator Mode** is set to **Single**, only Oscillator 1's filters are active; the pages for Oscillator 2's filters will be grayed out.

6-1: BASIC

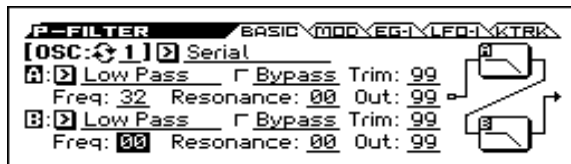

This page contains all of the basic settings for Oscillator 1's Filter A and Filter B. For example, you can:

- Set up the filters to produce a single 12 dB/oct filter, dual 12 dB/oct filters in either serial or parallel routing, or a single 24 dB/oct filter.
- Set each of the two filters to Low Pass, High Pass, Band Pass, or Band Reject modes.
- Set the cutoff, resonance, and input and output levels of each filter, including modulation of resonance and output level.

OSC (Oscillator Select) [1, 2]

Select the oscillator (1 or 2) that you want to edit.

Note: Oscillator 2 can be selected if Oscillator Mode is set to Double.

Filter Routing [Single, Serial, Parallel, 24dB(4Pole)]

Each oscillator has two filters, Filter A and Filter B. This parameter controls whether one or both of the filters are used, and if both are used, it controls how they are connected to each other.

Single. This uses only Filter A as a single 2-pole, 12 dB/octave filter (6 dB/oct for Band Pass and Band Reject). When this option is selected, the controls for Filter B will be grayed out.

Serial. This uses both Filter A and Filter B. The oscillator first goes through Filter A, and then the output of Filter A is processed through Filter B.

Parallel. This also uses both Filter A and Filter B. The oscillator feeds both filters directly, and the outputs of the two filters are then summed together.

24dB/oct. This merges both filters to create a single 4-pole, 24 dB/octave filter (12 dB/oct for Band Pass and Band Reject). In comparison to Single, this option produces a sharper roll-off beyond the cutoff frequency, as well as a slightly more delicate resonance. Many classic analog synths used this general type of filter.

When 24 dB/oct is selected, only the controls for Filter A are active; the controls for Filter B will be grayed out.

Serial and Parallel Routing

Serial

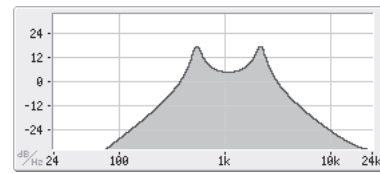
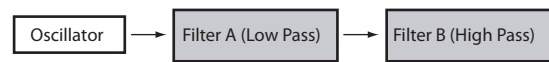

Parallel

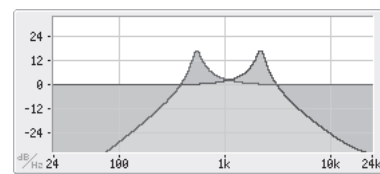
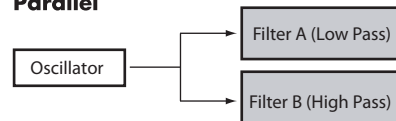

12db/oct / 24db/oct

Low Pass:
12dB/oct

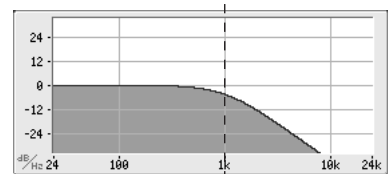

Low Pass:
24dB/oct

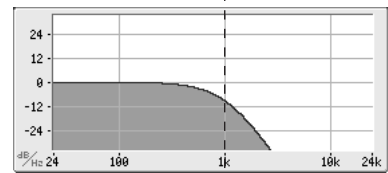

A (Filter A)

Type (Filter Type) [Low Pass (12dB/oct), High Pass (12dB/oct), Band Pass (6dB/oct), Band Reject (6dB/oct)]

The filter will produce very different results depending on the selected filter type. The selections will change slightly according to the selected **Filter Routing**, to show the correct cutoff slope in dB per octave.

Low Pass (12dB/oct). This cuts out the parts of the sound which are **higher** than the cutoff frequency. Low Pass is the most common type of filter, and is used to make bright timbres sound darker.

High Pass (12dB/oct). This cuts out the parts of the sound which are **lower** than the cutoff frequency. You can use this to make timbres sound thinner or more buzzy.

Band Pass (6dB/oct). This cuts out all parts of the sound, both highs and lows, except for the region around the cutoff frequency. Since this filter cuts out both high and low frequencies, its effect can change dramatically depending on the cutoff setting and the oscillator's multisample.

With low resonance settings, you can use the Band Pass filter to create telephone or vintage phonograph sounds. With higher resonance settings, it can create buzzy or nasal timbres.

Band Reject (6dB/oct). This filter type also called a notch filter—cuts only the parts of the sound directly around the cutoff frequency. Try modulating the cutoff with an LFO to create phaser-like effects.

Filter Types and Cutoff Frequency

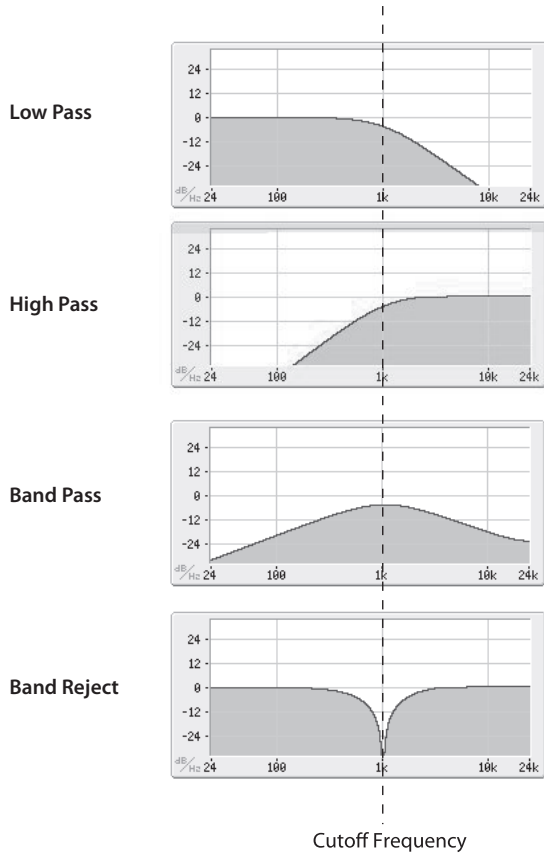

To make the resonance track the keyboard pitch, please see “Key Follow” on page 27.

Out (Output) [00...99]

This controls the output level of Filter A. You can use this to balance the volumes of Filters A and B when the **Routing** is set to **Parallel**, or to turn down the volume to avoid clipping later in the signal chain.

B (Filter B)

Filter B is available when the **Filter Routing** is set to **Serial** or **Parallel**. Otherwise, the parameters in this section will be grayed out.

The parameters for Filter B are identical to those for Filter A. For more information, please see the descriptions under Filter A, above.

Bypass [Off, On]

This lets you bypass Filter A completely.

If **Bypass** is **Off**, Filter A functions normally.

When **Bypass** is **On**, Filter A will have no effect.

Trim (Input Trim) [00...99]

This adjusts the volume level at the input to the filter. If you notice that the sound is distorting, especially with high **Resonance** settings, you can turn the level down here or at the **Output**.

Freq (Cutoff Frequency) [00...99]

This controls the cutoff frequency of Filter A, in increments of 1/10 of an octave. The specific effect of the cutoff frequency will change depending on the selected **Filter Type**.

Resonance [00...99]

Resonance emphasizes the frequencies around the cutoff frequency.

When this is set to 0, there is no emphasis, and frequencies beyond the cutoff will simply diminish smoothly.

At medium settings, the resonance will alter the timbre of the filter, making it sound more nasal, or more extreme.

At very high settings, the resonance can be heard as a separate, whistling pitch.

Resonance

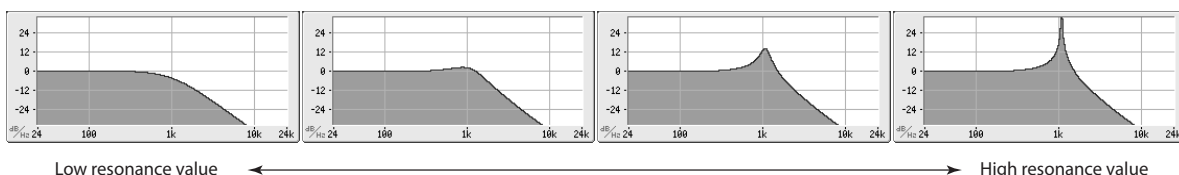

6-2: MOD (Modulation)

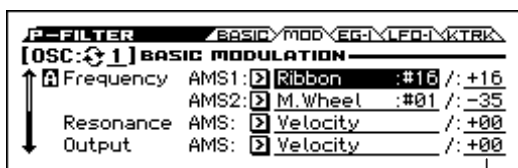

AMS Intensity

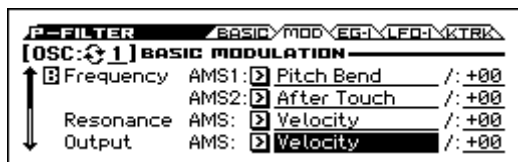

Here you can adjust settings for the modulation that controls the filter. You can use any AMS source to control the cutoff frequency and resonance of each filter.

OSC (Oscillator Select) [1, 2]

Select the oscillator (1 or 2) that you want to edit.

Note: Oscillator 2 can be selected if Oscillator Mode is set to Double.

A (Filter A)

Frequency

AMS1 [List of AMS Sources]

This selects the first modulation source for controlling Filter A's cutoff frequency. For a list of AMS sources, please see "AMS (Alternate Modulation Source) List" on page 282.

AMS Intensity (Cutoff AMS1 Intensity) [-99...+99]

This controls the depth and direction of AMS1.

AMS2 [List of AMS Sources]

This selects the second modulation source for controlling Filter A's cutoff frequency. For a list of AMS sources, please see "AMS (Alternate Modulation Source) List" on page 282.

AMS Intensity (Cutoff AMS2 Intensity) [-99...+99]

This controls the depth and direction of AMS2.

Resonance

AMS [List of AMS Sources]

This selects a AMS source to control the Resonance amount. For a list of AMS sources, please see "AMS (Alternate Modulation Source) List" on page 282.

AMS Intensity [-99...+99]

This controls the depth and direction of the Resonance modulation.

For example, if Velocity has been selected, changes in keyboard velocity will affect the resonance. With positive (+) values, the resonance will increase as you play more strongly, and as you play more softly the resonance will approach the level specified by the **Resonance** setting. With negative (-) values, the resonance will decrease as you play more strongly, and as you play more softly the resonance will approach the level specified by the **Resonance** setting.

The resonance level is determined by adding the **Resonance** and **AMS Int.** values.

Output

AMS [List of AMS Sources]

This selects a modulation source to control the output level of Filter A. For a list of AMS sources, please see "AMS (Alternate Modulation Source) List" on page 282.

AMS Int. [-99...+99]

This controls the depth and direction of the output level modulation.

B (Filter B)

The parameters for Filter B are identical to those for Filter A. For more information, please see the descriptions under Filter A, above.

6-3: EG-I (EG Intensity)

Here you can specify the modulation that controls the amount of effect that the filter EG has on the cutoff frequency. For example you can specify how velocity controls the way that the EG changes the cutoff frequency.

The total modulation that's specified on this page will be the amount of EG that's actually applied to the cutoff frequency.

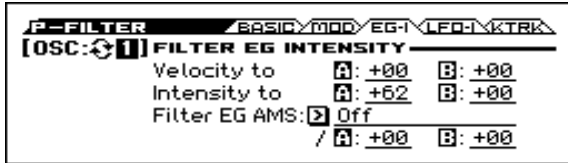

Note: To set up the EG itself, including attack and release times, levels, and so on, please see “7: P-FILTER EG (Filter Envelope)” on page 28.

OSC (Oscillator Select) [1, 2]

Select the oscillator (1 or 2) that you want to edit.

Note: Oscillator 2 can be selected if Oscillator Mode is set to Double.

Velocity to A [-99...+99]

This lets you use velocity to scale the amount of the Filter EG applied to Filter A.

Velocity control of Filter EG

In all examples below, Intensity to A = +50

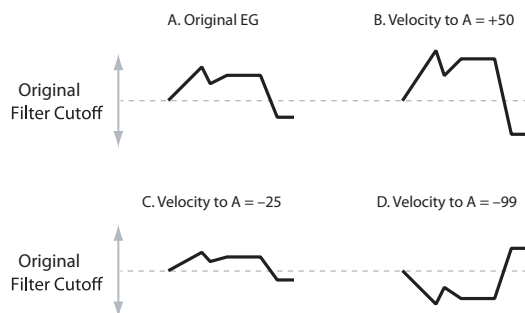

With **positive (+) values**, playing more strongly will increase the effect of the Filter EG, as shown in example **B** above.

With **negative (-) values**, playing more strongly will introduce the opposite effect of the Filter EG—like inverting the polarity of the envelope. You can use this in several different ways:

- You can set an initial positive amount with the Intensity to A/B parameters, and then reduce this amount with velocity. In this case, the final effect of the EG is simply diminished, and not actually inverted, as shown in example **C** above.
- You can also set the Velocity to A/B amounts so that they are greater than the initial amounts of Intensity to A/B. In this case, the EG will have a positive effect at low velocities, and an inverted effect at high velocities as shown in example **D**.

Velocity to B [-99...+99]

This lets you use velocity to scale the amount of the Filter EG that's applied to Filter B. For more information, please see “Velocity to A” above.

Intensity to A [-99...+99]

This controls the initial effect of the Filter EG on Filter A's cutoff frequency, before any velocity or AMS modulation.

The Filter EG's shape can swing all the way from +99 to -99. Positive values increase the cutoff frequency, and negative values decrease the cutoff frequency. For instance, please see the graphic “Velocity control of Filter EG” above. The EG shape in example **A** rises up at first, and then falls below 0 towards the end.

When **Intensity to A** is set to a **positive (+)** value, the EG's effect will match its shape. When the EG rises above 0, the cutoff frequency will increase.

With **negative (-)** values, the effect will be in the opposite direction; when the EG rises above 0, the filter cutoff will decrease.

Intensity to B [-99...+99]

This controls the initial effect of the Filter EG on Filter B's cutoff frequency, before any velocity or AMS modulation. For more information, please see “Intensity to A” above.

AMS (Filter EG AMS) [List of AMS Sources]

This selects any AMS modulation source to scale the amount of the Filter EG that's applied to Filters A and B. The two filters share a single AMS source, with separate intensity settings. Otherwise, the AMS modulation will work in the same way as the **Velocity to A** parameter, described above.

For a list of AMS sources, please see “AMS (Alternate Modulation Source) List” on page 282.

Int to A (AMS Intensity to A) [-99...+99]

This controls the depth and direction of the EG AMS modulation for Filter A.

Int to B (AMS Intensity to B) [-99...+99]

This controls the depth and direction of the EG AMS modulation for Filter B.

6-4: LFO-I (LFO Intensity)

LFO1, LFO2, and the Common LFO can all modulate Filter A and B's cutoff frequencies. You can control the strength of each LFO's modulation independently for each filter, in three different ways:

- Set an initial amount of LFO modulation, using the **Intensity to A** and **B** parameters.
- Use JS-Y to scale the amount of the LFO.
- Use any AMS source to scale the amount the LFO.

You can use each of these methods for each of the three LFOs, and do so separately for both Filter A and Filter B. The results are added together to produce the total LFO effect.



OSC (Oscillator Select) [1, 2]

Select the oscillator (1 or 2) that you want to edit.

Note: Oscillator 2 can be selected if Oscillator Mode is set to Double.

LFO1

Intensity to A [-99...+99]

This controls the initial effect of LFO1 on Filter A's cutoff frequency, before any JS-Y or AMS modulation.

Negative (-) settings will invert the phase of the LFO. You can produce interesting effects by using the same LFO to modulate two different parameters (such as Filter A and Filter B), but with one set to a positive intensity, and the other set to a negative intensity.

LFO modulation of Filter Cutoff

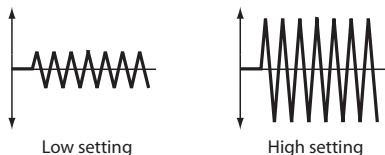

Intensity to B [-99...+99]

This controls the initial effect of the LFO on Filter B's cutoff frequency, before any JS-Y or AMS modulation.

JS-Y Intensity to A [-99...+99]

This adjusts the depth by which the LFO will modulate the cutoff frequency of filter A when CC#2 is received.

Note: The -Y direction of joystick control is called "JS-Y." Although a joystick is a controller that's provided on many Korg instruments, the KROSS is not equipped with a joystick.

Negative (-) settings will invert the phase of the LFO. You can also use this to reduce the initial amount of the LFO, as set by **Intensity to A**, above. For example:

1. Set Intensity to A to +50.

The LFO will now have a fairly strong effect on the filter cutoff.

2. Set JS-Y Intensity to A to -50.

Now, if you move the joystick down, the effect of the LFO will fade away. When the joystick is all the way at the bottom of its range, the LFO will be completely cancelled out.

JS-Y Intensity to B (LFO1) [-99...+99]

This lets you use JS-Y to scale the amount of the LFO applied to Filter B.

AMS (LFO1) [List of AMS Sources]

This selects any AMS modulation source to scale the amount of the LFO applied to Filters A and B. The two filters share a single AMS source, but with separate intensity settings.

For a list of AMS sources, please see "AMS (Alternate Modulation Source) List" on page 282.

AMS Intensity to A (LFO1) [-99...+99]

This controls the depth and direction of the LFO1 AMS modulation for Filter A.

For example, if AMS is set to **M.Wheel: #01**, **positive** settings mean that YS+Y will increase the amount of LFO1 applied to Filter A.

AMS Intensity to B (LFO1) [-99...+99]

This controls the depth and direction of the LFO1 AMS modulation for Filter B.

LFO 2

The parameters for LFO2 are identical to those for LFO1. For more information, please see the descriptions under LFO1, above.

Common LFO

The parameters for the Common LFO are identical to those for LFO1. For more information, please see the descriptions under LFO1, above.

Note that while LFO1 and LFO2 are separate for each voice, the Common LFO is shared by all voices in the Program. This makes it useful when you want all of the voices to have an identical LFO effect.

6-5: KTRK (Keyboard Track)

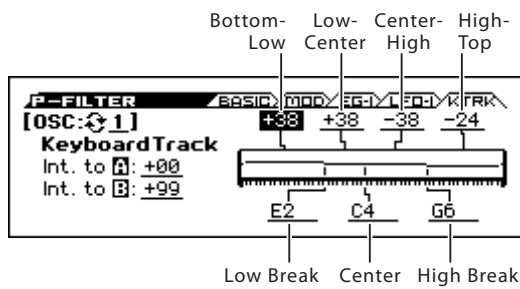

This page contains the settings for Oscillators 1 and 2's filter keyboard track. Among other things, you can set up complex keyboard tracking shapes, and control how the tracking affects filter cutoff.

Filter B is available when the **Filter Routing** is set to **Serial** or **Parallel**. Otherwise, the parameters for Filter B will be grayed out.

Most acoustic instruments get brighter as you play higher pitches. At its most basic, keyboard tracking re-creates this effect by raising the lowpass filter cutoff frequency as you play higher on the keyboard. Usually, some amount of key tracking is necessary in order to make the timbre consistent across the entire range.

The KROSS keyboard tracking can also be much more complex, since it allows you to create different rates of change over up to four different parts of the keyboard. For instance, you can:

- Make the filter cutoff increase very quickly over the middle of the keyboard, and then open more slowly or not at all in the higher octaves.
- Make the cutoff increase as you play lower on the keyboard.
- Create abrupt changes at certain keys, for split-like effects.

How it works: Keys and Ramps

The keyboard tracking works by creating four ramps, or slopes, between five keys on the keyboard. The bottom and top keys are fixed at the bottom and top of the MIDI range, respectively. You can set the other three keys named **Key Low**, **Center**, and **Key High** to be anywhere in between.

The four Ramp values control the rate of change between each pair of keys. For instance, if the **Low-Center** Ramp is set to 0, the value will stay the same between the **Key Low** key and the **Center** key.

The **Key** value will be the break point, and the slope of the lower and higher regions on the keyboard is specified by the Ramp.

At the **Center** key (the main hinge), the keyboard tracking has no effect.

OSC (Oscillator Select) [1, 2]

Select the oscillator (1 or 2) that you want to edit.

Note: Oscillator 2 can be selected if Oscillator Mode is set to Double.

Int. to A (Intensity to A) [-99...+99]

This controls how much the keyboard tracking will affect Filter A's cutoff frequency. The overall effect of the Keyboard Track is a combination of this Intensity value and the overall Keyboard Track shape.

With **positive values (+)**, the effect will be in the direction specified by keyboard tracking; if the ramp goes up, the filter cutoff will **increase**.

With **negative values (-)**, the effect will be in the opposite direction; if the ramp goes up, the filter cutoff will **decrease**.

Keyboard Track Shape and Intensity

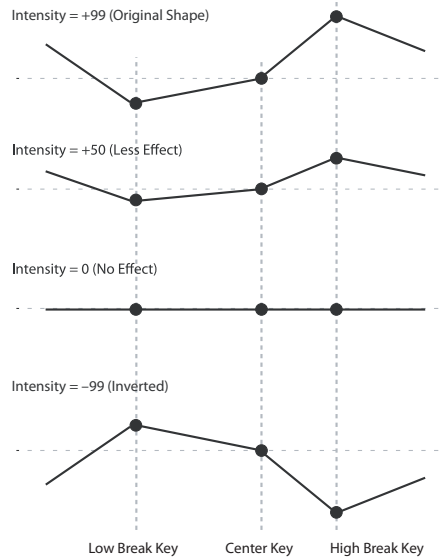

Int. to B (Intensity to B) [-99...+99]

This controls how much the keyboard tracking will affect Filter B's cutoff frequency.

Key

Low Break [C-1...G9]

This specifies the note where the two sloped lines in the lower range will be connected.

Center [C-1...G9]

This specifies the note that will be the break point for the center of keyboard tracking. At this key, the keyboard tracking has no effect on the filter cutoff, or on any AMS destinations.

High Break [C-1...G9]

This specifies the note where the two sloped lines in the upper range will be connected.

Tip: You can also set the note value and velocity value by the keyboard (see page 12 of the Operation Guide).

Ramp

Positive ramp values mean that the keyboard tracking output increases as you play farther from the **Center**; negative ramp values mean that it decreases.

Because of this, the meanings of positive and negative ramp settings will change depending on whether the ramp is to the left or right of the **Center**.

Bottom-Low and Low-Center: negative ramps make the keyboard tracking's output go down as you play lower on the keyboard, and positive ramps make the output go higher.

Center-High and High-Top: negative ramps make the keyboard tracking's output go down as you play higher on the keyboard, and positive ramps make the output go up.

The effect on the filter cutoff is a combination of the ramp values, as set below, and the **Intensity to A (B)** parameters. When **Intensity to A (B)** is set to +99, a ramp of 50 changes the filter frequency by 1 octave for every octave of the keyboard, and a ramp of +99 changes the frequency by 2 octaves for every octave of the keyboard.

Bottom-Low [-Inf, -99...+99, +Inf]

This sets the slope between the bottom of the MIDI note range and the **Low Break**. For normal key track, use negative values.

Low-Center [–Inf, –99...+99, +Inf]

This sets the slope between the **Low Break** and **Center**. For normal key track, use negative values.

Center-High [–Inf, –99...+99, +Inf]

This sets the slope between the **Center** and **High Break**. For normal key track, use positive values.

High-Top [–Inf, –99...+99, +Inf]

This sets the slope between the **High Break** and the top of the MIDI note range. For normal key track, use positive values.

+Inf and –Inf ramps

+Inf and –Inf are special settings which create abrupt changes for split-like effects. When a ramp is set to +Inf or –Inf, the keyboard tracking will go to its extreme highest or lowest value over the span of a single key.

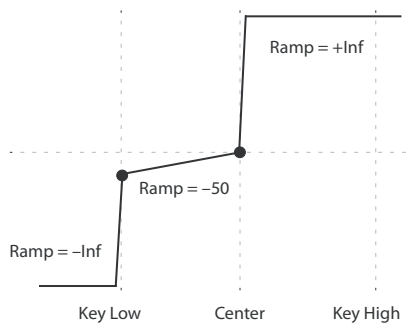
+Inf and –Inf Ramps

Note: if you set the **Center-High** ramp to +Inf or –Inf, the **High-Top** parameter will be grayed out. Similarly, if you set the **Low-Center** ramp to +Inf or –Inf, the **Bottom-Low** ramp will be grayed out.

Key Follow

To create the classic Key Follow effect, in which the filter frequency tracks the pitch of the keyboard:

1. Set the **Filter Freq (Frequency)** to 30.
2. Set the **Keyboard Track Int. to A (Intensity to A)** to +99.
3. Set the **Bottom-Low** and **Low-Center** ramps to –50.
4. Set the **Center-High** and **High-Top** ramps to +50.
5. Set the **Center** to C4.

The settings for the **Low Break** and **High Break** keys don't matter in this case.

Filter Keyboard Track is also an AMS source

You can use the filter keyboard tracking as an AMS source to modulate other parameters, just like the envelopes and LFOs. Simply select **Filter KTrk** in the AMS list for the desired parameter.

✓ 6-1...5: FUNCTION

- 0: **Write Program, Write/Initialize Program** see page 63
- 1: **Solo Setting** see page 63
- 2: **Compare** see page 64
- 3: **Auto Song Setup** see page 64
- 4: **Add to Favorite** see page 64
- 5: **Copy Oscillator** see page 64
- 6: **Swap Oscillator** see page 64

For more information, please see the “Program: Function” section on page 63.

7: P-FILTER EG (Filter Envelope)

AMSource

The Filter EG, or Envelope Generator, lets you create complex, time-varying changes to the cutoff frequencies of Filters A and B. The parameters on this page control the shape of the EG. Among other things, you can:

- Create the basic EG shape by setting the levels and times of each segment.
- Control the curvature of each EG segment, for subtle control over the modulation shape of the EG.
- Set up complex modulation of EG levels and times.
- Set up an AMS source, such as an LFO, to restart the EG.

To control how much effect the EG has on the filters, use the Filter EG parameters on the P-FILTER> EG-I page, as described under “6-3: EG-I (EG Intensity)” on page 24.

Filter EG is also an AMS source

You can use the Filter EG as an AMS source to modulate other parameters, just like the keyboard tracking and LFOs. Simply select the Filter EG in the AMS list for the desired parameter.

7-1: ENVELOPE

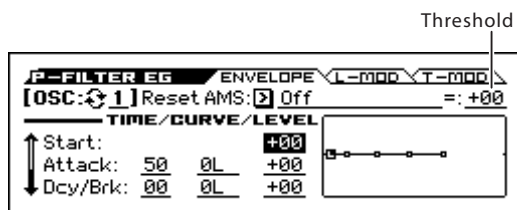

OSC (Oscillator Select)

[1, 2]

Select the oscillator (1 or 2) that you want to edit.

Note: Oscillator 2 can be selected if Oscillator Mode is set to Double.

Reset AMS

[List of AMS Sources]

This selects an AMS source to reset the EG to the start point. For instance, you can use a tempo-synced LFO to trigger the EG in a repeating rhythm. This reset is in addition to the initial note-on, which always causes the EG to start.

For a list of AMS sources, please see “AMS (Alternate Modulation Source) List” on page 282.

Threshold

[-99...+99]

This sets the AMS level which will trigger the EG reset. Among other things, you can use this to adjust the exact point in an LFO’s phase where the EG will be reset, effectively controlling its “groove” against other rhythmic effects.

When the threshold is **positive**, the EG triggers when passing through the threshold moving upwards. When the threshold is **negative**, the EG triggers when passing through the threshold moving downwards.

Note: With some LFO shapes, and with faster LFO speeds, the LFO may not always reach the extreme values of +99 or -99. In this case, setting the **Threshold** to these values may cause inconsistent behavior, or may mean that the EG doesn’t reset at all. If this happens, reduce the **Threshold** until the EG triggers consistently.

Filter EG

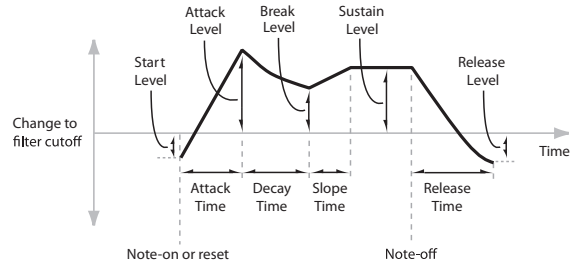

An envelope creates a modulation signal by moving from one level to another over a specified time, and then moving to another level over another period of time, and so on.

The parameters below let you set five levels, the amount of time it takes to go from each of the levels to the next, and the shape (from linear to curved) of each transition.

Time

Higher values mean longer times, as shown below:

EG Value	Actual Time
10	10 ms
20	44 ms
30	104 ms
40	224 ms
50	464 ms
60	944 ms
70	1.8 seconds
80	3.8 seconds
90	10.9 seconds
99	87.3 seconds

Attack

[00...99]

This sets how long the EG takes to move from the Start level to the Attack level.

For the fastest possible attack time, you can set the Start level to +99; in this case, the EG will start instantaneously at its maximum value.

Dcy/Brk (Decay)

[00...99]

This sets the time it takes to move from the Attack level to the Break level.

Slp/Sus (Slope)

[00...99]

This sets how long the EG takes to move from the Break level to the Sustain level. Once it reaches the Sustain level, the EG will stay there until note-off (unless it is reset via AMS).

Release

[00...99]

This sets how long it takes the EG to move from the Sustain level to the Release level.

Curve

For the sake of simplicity, most of the diagrams in this manual show envelopes as being made out of straight lines. In actuality, though, envelopes are more likely to be made out of curves.

In other words, each segment’s level will change quickly at first, and then slow down as it approaches the next point. This tends to sound better than straight, linear segments.

Classic analog synth envelopes made these curved shapes naturally. The KROSS goes a step further than vintage synths, however, and lets you control the amount of curvature separately for each of the four envelope segments.

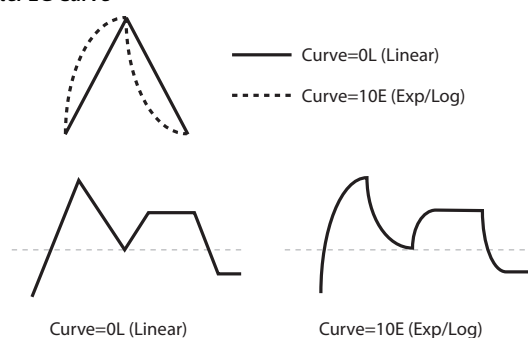
Filter EG Curve

When you change the curvature, the EG times remain the same. However, greater curvature will tend to sound faster, because the value changes more quickly at the beginning.

Different curve settings for up and down

You may find that different amounts of curvature are suitable for segments which go up and segments which go down.

For instance, a curve of 3 is a good default setting for upward segments, such as Attack. On the other hand, a curve of 6 or more is good for downward segments, such as Decay and Release.

Attack [0L (Linear), 1...9, 10E (Exp/Log)]

This sets the curvature of the Attack segment - the transition from the Start level to the Attack level.

Dcy/Brk (Decay) [0L (Linear), 1...9, 10E (Exp/Log)]

This sets the curvature of the Decay segment - the transition from the Attack level to the Break level.

Slp/Sus (Slope) [0L (Linear), 1...9, 10E (Exp/Log)]

This sets the curvature of the Slope segment - the transition from the Break level to the Sustain level.

Release [0L (Linear), 1...9, 10E (Exp/Log)]

This sets the curvature of the Release segment - the transition from the Sustain level to the Release level.

Level

Each of the five levels can be either positive or negative.

Positive levels will make the cutoff frequency (or other AMS destination) go up from its programmed value; **negative** levels will make it go down.

Start [-99...+99]

This sets the initial EG level at note-on.

Attack [-99...+99]

This sets the level at the end of the Attack time.

Dcy/Brk (Break) [-99...+99]

Break, short for Break Point, sets the level at the end of the Decay time.

Slp/Sus (Sustain) [-99...+99]

This sets the level at the end of the Slope time. Once it reaches the Sustain level, the EG will stay there until note-off, unless it is reset via AMS.

Release [-99...+99]

This sets the level at the end of the Release time.

EG Display

This shows the shape of the EG that's specified by the P-FILTER EG settings. The location of the selected parameter is shown.

7-2: L-MOD (Level Modulation)

These settings let you use any AMS source to control the Level parameters of the EG. The Start, Attack, and Break levels share a single AMS source, but can each have different modulation intensities.

By using different settings for each of the three levels, you can cause both subtle and dramatic changes to the EG shape, as shown below.

Once the EG has started a segment between two points, that segment can no longer be modulated. This includes both the time of the segment, and the level reached at the end of the segment.

For instance, if the EG is in the middle of the Decay time, you can no longer modulate either the Decay time or the Break level.

As another example, let's say that you've assigned the Common LFO to modulate the Break Level. The LFO may be moving all the time, but the Break Level is only affected by the LFO's value at the instant that the Decay segment starts. After that, the level is fixed.

Finally, this also means that modulating the Start level, Attack level, or Attack time will not affect notes that are already sounding, unless the EG is then reset via AMS.

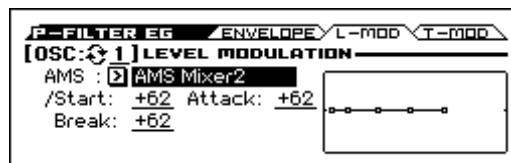
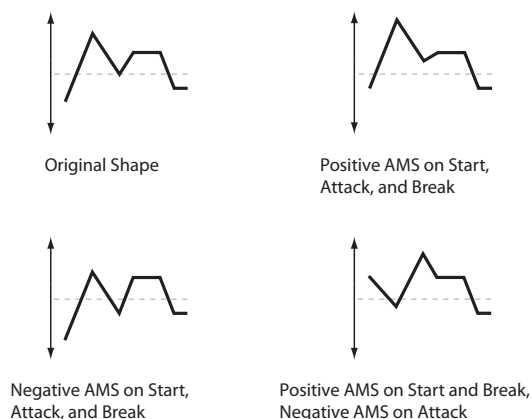
Filter EG Level Modulation**OSC (Oscillator Select)** [1, 2]

Select the oscillator (1 or 2) that you want to edit.

Note: Oscillator 2 can be selected if Oscillator Mode is set to Double.

AMS [List of AMS Sources]

Selects an AMS source to control the EG's Level parameters.

For a list of AMS sources, please see "AMS (Alternate Modulation Source) List" on page 282.

Start [-99...+99]

This controls the depth and direction of the AMS modulation for the Start level.

For example, if you set the AMS source to Velocity and set **St (Start)** to +99, the Start level will increase as you play harder. If you instead set **St (Start)** to -99, the Start level will decrease as you play harder.

Attack [-99...+99]

This controls the depth and direction of the AMS modulation for the Attack level.

Break [-99...+99]

This controls the depth and direction of the AMS modulation for the Break level.

EG Display

This shows the shape of the EG that's specified by the P-FILTER EG settings. The location of the selected parameter is also shown.

7-3: T-MOD (Time Modulation)

These settings let you use three different AMS sources to control the Time parameters of the EG. For each of the three AMS sources, the Attack, Decay, Slope, and Release times each have their own modulation intensities.

Filter EG Time Modulation

AMS=Velocity, Intensity = a positive (+) value

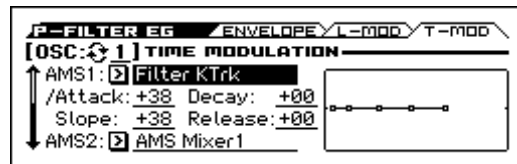
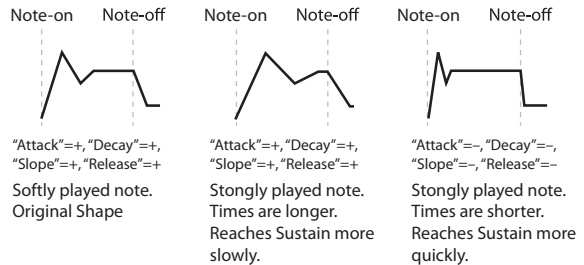

OSC (Oscillator Select) [1, 2]

Select the oscillator (1 or 2) that you want to edit.

Note: Oscillator 2 can be selected if Oscillator Mode is set to Double.

AMS1

AMS1 [List of AMS Sources]

Selects the first AMS source to control the EG's Time parameters. Velocity and Keyboard Track can both be useful here for instance.

For a list of AMS sources, please see "AMS (Alternate Modulation Source) List" on page 282.

Attack [-99...+99]

This controls the depth and direction of the AMS modulation for the Attack time.

For example, if you set the AMS source to Velocity and set **At (Attack)** to +99, the Attack time will get much longer at higher velocities. If you instead set **At (Attack)** to -99, the Attack time will get much shorter at higher velocities.

When the AMS source is at its maximum value for instance, when **Velocity** is at 127 a setting of +8 will make the Attack time almost twice as long, and a setting of -8 will cut the Attack time almost in half. (see page 284)

Decay [-99...+99]

This controls the depth and direction of the AMS modulation for the Decay time.

Slope [-99...+99]

This controls the depth and direction of the AMS modulation for the Slope time.

Release [-99...+99]

This controls the depth and direction of the AMS modulation for the Release time.

AMS2 and AMS3

These select the second and third AMS sources, respectively, for controlling the EG's Time parameters. Each has its own intensities

for Attack, Decay, Slope, and Release. The parameters of both AMS2 and AMS3 are identical to those of AMS1, above.

EG Display

This shows the shape of the EG that's specified by the P-FILTER EG settings. The location of the selected parameter is also shown.

✓ **7-1...3: FUNCTION**

- 0: **Write Program, Write/Initialize Program** see page 63
- 1: **Solo Setting** see page 63
- 2: **Compare** see page 64
- 3: **Auto Song Setup** see page 64
- 4: **Add to Favorite** see page 64
- 5: **Copy Oscillator** see page 64
- 6: **Swap Oscillator** see page 64
- 7: **Sync Both EGs** see page 65 (only ENVELOPE page)

For more information, please see the “Program: Function” section on page 63.

8: P–Amp

Oscillators 1 and 2 have separate controls for volume (also called “amplitude,” or “amp” for short), pan, dedicated amp envelopes and keyboard tracking generators.

These pages let you control all of these related parameters. Among other things, you can:

- Set the pan position and pan modulation.
- Control amp level and modulation, including keyboard tracking, the amp envelope, LFO modulation, and AMS control.

Note that when the **Oscillator Mode** is set to **Single**, only Oscillator 1’s amp and pan parameters are active; the pages for Oscillator 2 will be grayed out.

8–1: BASIC



AMS Intensity

This page controls the basic settings for the Amp section. Here you can:

- Set the initial volume level.
- Control the pan position and pan modulation.

OSC (Oscillator Select) [1, 2]

Select the oscillator (1 or 2) that you want to edit.

Note: Oscillator 2 can be selected if Oscillator Mode is set to Double.

Amp Level [000...127]

This controls the basic volume level of Oscillator 1, before keyboard tracking, velocity, and other modulation.

Mixer, DrumTrack and volume

You can control the Oscillator volume directly from the sliders in the 0–3 Mixer page. This is a separate parameter, in addition to **Amp Level**.

MIDI and volume

MIDI You can control the Program’s overall volume via MIDI using both Volume (CC#7) and Expression (CC#11). When used one at a time, the two controllers work in exactly the same way: a MIDI value of 127 is equal to the **Amp Level** setting, and lower values reduce the volume.

If both CC#7 and CC#11 are used simultaneously, the one with the lower value determines the maximum volume, and the one with the higher value scales down from that maximum. This is controlled on the global MIDI channel (see page 159).

Pan [Random, L001...C064...R127]

This controls the stereo pan of Oscillator 1. A setting of **L001** places the sound at the far left, **C064** in the center, and **R127** to the far right.

When this is set to **Random**, the pan position will be different for each note-on.

MIDI You can also control pan via MIDI Pan (CC#10). A CC#10 value of 0 or 1 places the sound at the far left, 64 places the sound at the location specified by the **Pan** parameter, and 127 places the sound at the far right. This is controlled on the global MIDI channel (see page 159).

Note: Random cannot be selected via a MIDI control change. You’ll need to select it here.

AMS (Pan) [List of AMS Sources]

This selects an AMS source to modulate Pan.

For a list of AMS sources, please see “AMS (Alternate Modulation Source) List” on page 282.

AMS Intensity [–99...+99]

This controls the depth and direction of the AMS modulation for Pan settings.

For example, if **Pan** is set to C064 and **AMS** is set to Note Number, **positive (+)** intensities will cause the sound to move toward the right as you play higher than C4, and toward the left as you play lower than C4. **Negative (–)** intensities will have the opposite effect.

DKIT-SET (Use DKit Setting) [Off, On]

This option is available only when the **Oscillator Mode** is set to **Drums**.

Unlike standard Programs, Drum Kits can have a different pan setting for every note. This parameter lets you choose whether to use the Drum Kit pan settings, or to use the Program’s pan setting instead.

On (checked): The Program will use the Drum Kit’s per-note pan settings; pan AMS will still apply (see page 172). This is the default setting.

Off (unchecked): The Program will ignore the Drum Kit’s settings, and use the Program pan instead.

All keys of the drum kit will use the **Pan** setting.

8-2: MOD (Amp Modulation)

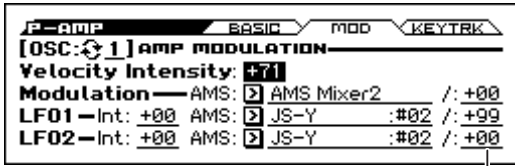

AMS Intensity

This page contains the settings for Oscillators 1 and 2's Amp level modulation. Among other things, you can:

- Assign AMS modulation for the Amp level.
- Control the effect of the LFOs on the Amp level.

You can modulate the Amp level by both velocity and an AMS source.

This modulation scales the basic Amp level and Amp EG level parameters. The resulting volume is determined by multiplying the volume changes of the amp EG by other values such as AMS. If these original levels are low, the maximum volume available with modulation will also be reduced.

OSC (Oscillator Select) [1, 2]

Select the oscillator (1 or 2) that you want to edit.

Note: Oscillator 2 can be selected if Oscillator Mode is set to Double.

Velocity to EG

Velocity Intensity [-99...+99]

With **positive (+)** values, the volume will increase as you play harder.

With **negative (-)** values, the volume will decrease as you play harder.

Velocity modulation of the Amp level, with Amp EG

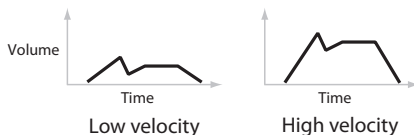

Modulation

AMS [List of AMS Sources]

This selects any AMS modulation source to control the Amp1 level. For a list of AMS sources, please see “AMS (Alternate Modulation Source) List” on page 282.

AMS Intensity [-99...+99]

This controls the depth and direction of the modulation.

For example, if **AMS** is set to **M.Wheel:#01**, **positive (+)** values of this parameter will make the volume increase when you move the modulation wheel away from yourself.

Note that if the other modulation settings have already raised the volume to its maximum level (double the **Amp Level** and Amp EG level settings), the volume cannot be increased any further.

LFO1

Intensity (LFO1) [-99...+99]

This controls the depth and direction of LFO1's effect on the oscillator's volume.

Negative (-) values will invert the LFO waveform.

AMS (LFO1) [List of AMS Sources]

This selects an AMS modulation source to scale the amount of the LFO1 that's applied to the Amp level.

For a list of AMS sources, please see “AMS (Alternate Modulation Source) List” on page 282.

AMS Intensity [-99...+99]

This controls the depth and direction of the LFO1 AMS modulation for the Amp level.

LFO2

The parameters for LFO2 are identical to those for LFO1. For more information, please see the descriptions under LFO1, above.

8-3: KEYTRK (Keyboard Track)

Keyboard tracking lets you vary the volume as you play up and down the keyboard. Usually, some amount of key tracking is necessary in order to make the volume consistent across the entire range.

KROSS's keyboard tracking can be fairly complex, if desired. You can create different rates of change over up to four different parts of the keyboard. For instance, you can:

- Make the volume increase very quickly over the middle of the keyboard, and then increase more slowly or not at all in the higher octaves.
- Make the volume increase as you play lower on the keyboard.
- Create abrupt changes at certain keys, for split-like effects.

For more information, please see the "How it works: Keys and Ramps" section on page 26.

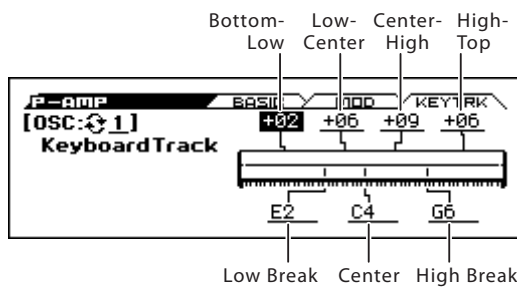

OSC (Oscillator Select) [1, 2]

Select the oscillator (1 or 2) that you want to edit.

Note: Oscillator 2 can be selected if Oscillator Mode is set to Double.

Key

Low Break [C-1...G9]

This specifies the note that will be the break point connecting the two sloped lines in the low region.

Center [C-1...G9]

This specifies the note that will be the break point in the center of keyboard tracking. At this key, the keyboard tracking has no effect on the volume, or on any AMS destinations.

High Break [C-1...G9]

This specifies the note that will be the break point connecting the two sloped lines in the high region.

Note: Tip: You can also set the note value by the keyboard (see page 12 of the Operation Guide).

Ramp

Positive ramp values mean that the keyboard tracking output increases as you play farther from the **Center Key**; negative ramp values mean that it decreases.

Because of this, the meanings of positive and negative ramp settings will change depending on whether the ramp is to the left or right of the **Center Key**.

Bottom-Low and Low-Center: negative ramps make the keyboard tracking's output go down as you play lower, and positive ramps make the output go higher.

Center-High and High-Top: negative ramps make the keyboard tracking's output go down as you play higher, and positive ramps make the output go up.

Differences from other Keyboard Tracks

There are several differences between the Amp keyboard tracking and the Filter and Common keyboard tracking.

For example, the results of the **Ramp** values are different. As shown in the graphic "Amp Keyboard Tracking," below, negative slopes are more steep than positive slopes.

Also, the amp does not have separate control of Intensity. Instead, Intensity is always fixed at the maximum amount, allowing keyboard tracking to change the volume from complete silence to twice as loud as the programmed level.

Bottom-Low [-Inf, -99...+99, +Inf]

This sets the slope between the bottom of the MIDI note range and the **Key Low** key. For normal key track, use negative values.

Low-Center [-Inf, -99...+99, +Inf]

This sets the slope between the **Key Low** and **Center** keys. For normal key track, use negative values.

Center-High [-Inf, -99...+99, +Inf]

This sets the slope between the **Center** and **Key High** keys. For normal key track, use positive values.

Amp Keyboard Tracking

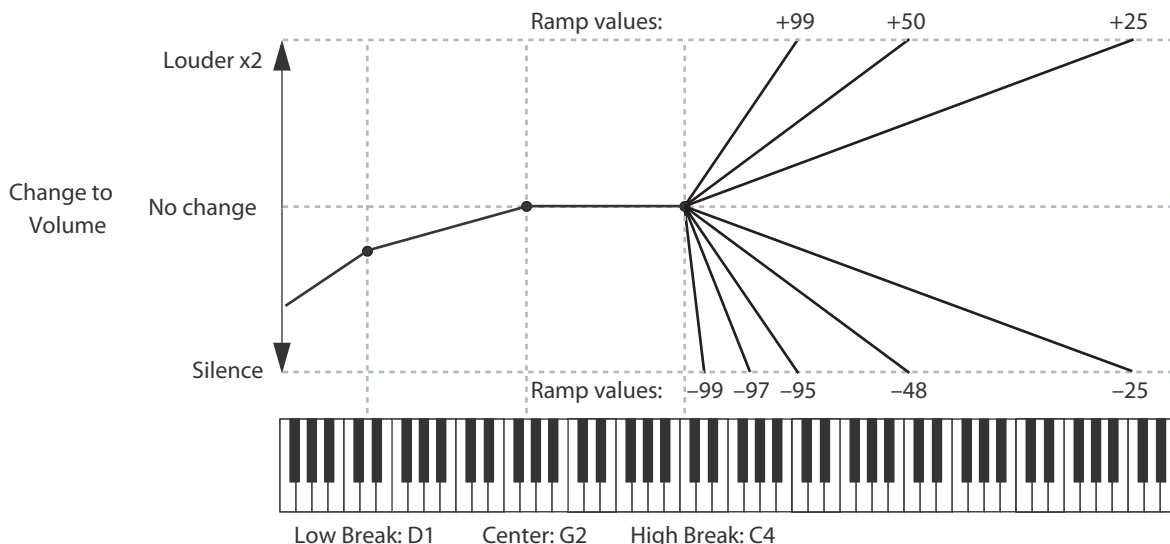

High-Top

[–Inf, –99...+99, +Inf]

This sets the slope between the **Key High** key and the top of the MIDI note range. For normal key track, use positive values.

Ramp	Change in level
–Inf	Silent in one half-step
–99	Silent in one whole-step
–95	Silent in one octave
–48	Silent in two octaves
–25	Silent in four octaves
00	no change
+25	x2 in four octaves
+50	x2 in two octaves
+99	x2 in one octave
+Inf	x2 in one half-step

+Inf and –Inf ramps

+Inf and –Inf are special settings which create abrupt changes for split-like effects. When a ramp is set to +Inf or –Inf, the keyboard tracking will go to its extreme highest or lowest value over the span of a single key.

When a ramp is set to +Inf, the keyboard tracking will go to its highest value (double the programmed volume) over a single half-step.

Similarly, when a ramp is set to –Inf, the keyboard tracking will go to its lowest value (complete silence) over a single half-step.

Note: If you set the **Cent Hi (Center-High)** ramp to +Inf or –Inf, the **Hi Top (High-Top)** parameter will be grayed out. Similarly, if you set the **Lo Cent (Low-Center)** ramp to +Inf or –Inf, the **Btm Lo (Bottom-Low)** ramp will be grayed out.

Amp KTrk is also an AMS source

You can use the keyboard tracking as an AMS source to modulate other parameters, just like the envelopes and LFOs. Simply select **Amp KTrk** in the AMS list for the desired parameter.

✓ 8-1...3: FUNCTION

- 0: **Write Program, Write/Initialize Program** see page 63
- 1: **Solo Setting** see page 63
- 2: **Compare** see page 64
- 3: **Auto Song Setup** see page 64
- 4: **Add to Favorite** see page 64
- 5: **Copy Oscillator** see page 64
- 6: **Swap Oscillator** see page 64

For more information, please see the “Program: Function” section on page 63.

9: P-AMP EG (Amp Envelope) AMS*Source*

9-1: ENVELOPE

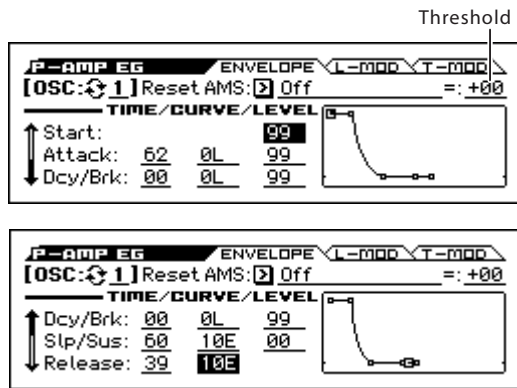

These parameters let you create time-varying changes in the volume of oscillators.

OSC (Oscillator Select) [1, 2]

Select the oscillator (1 or 2) that you want to edit.

Note: Oscillator 2 can be selected if Oscillator Mode is set to Double.

Reset AMS [List of AMS Sources]

This selects an AMS source to reset the EG to the start point. For instance, you can use a tempo-synced LFO to trigger the EG in a repeating rhythm. This reset is in addition to the initial note-on, which always causes the EG to start.

For a list of AMS sources, please see “AMS (Alternate Modulation Source) List” on page 282.

Note: Once the Amp EG is in its Release segment, it cannot be reset. (Otherwise, the sound might keep playing forever!)

Threshold [−99...+99]

This sets the AMS level which will trigger the EG reset.

Among other things, you can use this to adjust the exact point in an LFO’s phase where the EG will be reset, effectively controlling its “groove” against other rhythmic effects. When the threshold is **positive**, the EG triggers when passing through the threshold moving upwards. When the threshold is **negative**, the EG triggers when passing through the threshold moving downwards.

Note: With some LFO shapes, and with faster LFO speeds, the LFO may not always reach the extreme values of +99 or −99. In this case, setting the **Threshold** to these values may cause inconsistent behavior, or may mean that the EG doesn’t reset at all. If this happens, reduce the **Threshold** until the EG triggers consistently.

TIME/CURVE/LEVEL

These parameters specify how the amp 1 EG will change over time.

Amp EG

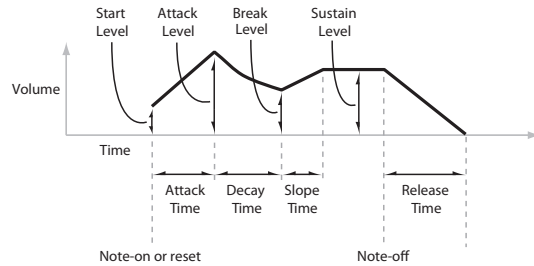

Level

Start [00...99]

This sets the initial volume level at note-on.

Attack [00...99]

This sets the level at the end of the Attack time.

Dcy/Brk (Break) [00...99]

Break, short for the Break Point, sets the level at the end of the Decay time.

Slp/Sus (Sustain) [00...99]

This sets the level at the end of the Slope time. Once it reaches the Sustain level, the EG will stay there until note-off (unless it is reset via AMS).

Time

Higher values mean longer times, as shown below.

EG Value	Actual Time
10	10 ms
20	44 ms
30	104 ms
40	224 ms
50	464 ms
60	944 ms
70	1.8 seconds
80	3.8 seconds
90	10.9 seconds
99	87.3 seconds

Attack [00...99]

This sets how long the EG takes to move from the Start level to the Attack level.

For the fastest possible attack time, you can set the Start level to +99; in this case, the EG will start instantaneously at its maximum value.

Dcy/Brk (Decay) [00...99]

This sets the time it takes to move from the Attack level to the Break level.

Slp/Sus (Slope) [00...99]

This sets how long the EG takes to move from the Break level to the Sustain level. Once it reaches the Sustain level, the EG will stay there until note-off (unless it is reset via AMS).

Release [00...99]

This sets how long it takes the EG to move from the Sustain level to silence.

Curve

For the sake of simplicity, most of the diagrams in this manual show envelopes as being made out of straight lines. In actuality, though, envelopes are more likely to be made out of curves.

In other words, each segment's level will change quickly at first, and then slow down as it approaches the next point. This tends to sound better than straight, linear segments.

Classic analog synth envelopes made these curved shapes naturally. The KROSS goes a step further than vintage synths, however, and lets you control the amount of curvature separately for each of the four envelope segments.

When you change the curvature, the EG times remain the same. However, greater curvature will tend to sound faster, because the value changes more quickly at the beginning.

Amp EG Curve

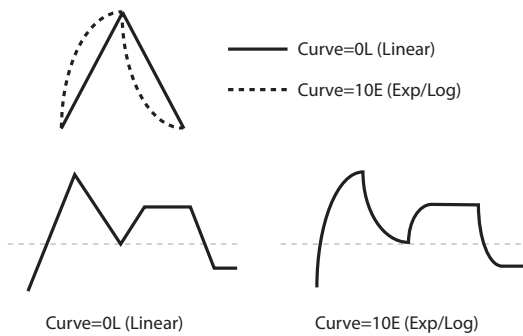

Different curve settings for up and down

You may find that different amounts of curvature are suitable for segments which go up and segments which go down.

For instance, a curve of 3 is a good default setting for upward segments, such as Attack. On the other hand, a curve of 6 or more is good for downward segments, such as Decay and Release.

Attack [0L (Linear), 1...9, 10E (Exp/Log)]

This sets the curvature of the Attack segment - the transition from the Start level to the Attack level.

Dcy/Brk (Decay) [0L (Linear), 1...9, 10E (Exp/Log)]

This sets the curvature of the Decay segment - the transition from the Attack level to the Break level.

Slp/Sus (Slope) [0L (Linear), 1...9, 10E (Exp/Log)]

This sets the curvature of the Slope segment - the transition from the Break level to the Sustain level.

Release [0L (Linear), 1...9, 10E (Exp/Log)]

This sets the curvature of the Release segment - the transition from the Sustain level to the Release level.

EG Display

This shows the shape of the EG that's specified by the P-AMP EG settings. The location of the selected parameter is shown.

9-2: L-MOD (Level Modulation)

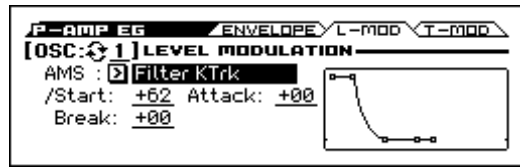

These settings let you use any AMS source to control the Level parameters of the EG. The Start, Attack, and Break levels share a single AMS source, but can each have different modulation intensities.

By using different settings for each of the three levels, you can cause both subtle and dramatic changes to the EG shape, as shown below.

Once the EG has started a segment between two points, that segment can no longer be modulated. This includes both the time of the segment, and the level reached at the end of the segment.

For instance, if the EG is in the middle of the Decay time, you can no longer modulate either the Decay time or the Break level.

As another example, let's say that you've assigned the Common LFO to modulate Break Level. The LFO may be moving all the time, but the Break Level is only affected by the LFO's value at the instant that the Decay segment starts. After that, the level is fixed.

Finally, this also means that modulating the Start level, Attack level, or Attack time will not affect notes that are already sounding, unless the EG is then reset via AMS.

Amp EG Level Modulation

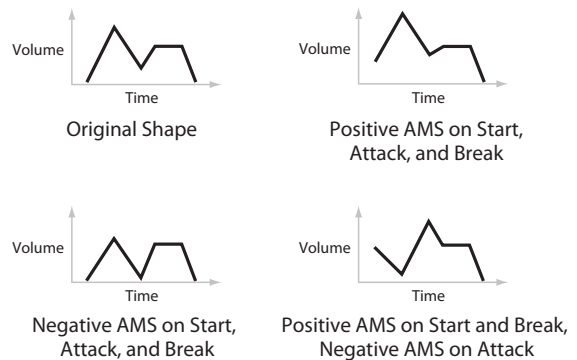

OSC (Oscillator Select) [1, 2]

Select the oscillator (1 or 2) that you want to edit.

Note: Oscillator 2 can be selected if Oscillator Mode is set to Double.

AMS Intensity

AMS [List of AMS Sources]

This selects an AMS source to control the EG's Level parameters.

For a list of AMS sources, please see "AMS (Alternate Modulation Source) List" on page 282.

Start [-99...+99]

This controls the depth and direction of the AMS modulation for the Start level.

For example, if you set the AMS source to Velocity and set **St (Start)** to +99, the Start level will increase as you play harder. If you instead set **St (Start)** to -99, the Start level will decrease as you play harder.

Attack [-99...+99]

This controls the depth and direction of the AMS modulation for the Attack level.

Break [-99...+99]

This controls the depth and direction of the AMS modulation for the Break level.

EG Display

This shows the shape of the EG that's specified by the P-AMP EG settings. The location of the selected parameter is shown.

9-3: T-MOD (Time Modulation)

These settings let you use three different AMS sources to control the Time parameters of the EG. For each of the three AMS sources, the Attack, Decay, Slope, and Release times each have their own modulation intensities.

Amp EG Time Modulation

AMS=Velocity, Intensity = a positive (+) value

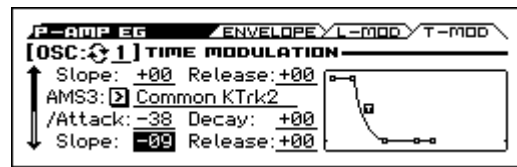
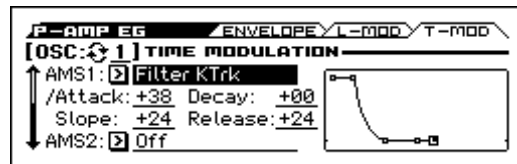
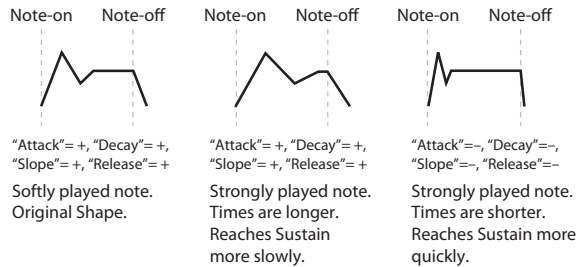

OSC (Oscillator Select) [1, 2]

Select the oscillator (1 or 2) that you want to edit.

Note: Oscillator 2 can be selected if Oscillator Mode is set to Double.

AMS1 Intensity

AMS1 [List of AMS Sources]

Selects the first AMS source to control the EG's Time parameters. Velocity and Keyboard Track can both be useful here for instance.

For a list of AMS sources, please see "AMS (Alternate Modulation Source) List" on page 282.

Attack [-99...+99]

This controls the depth and direction of the AMS modulation for the Attack time.

For example, if you set the AMS source to Velocity and set **At (Attack)** to +99, the Attack time will get much longer at higher velocities. If you instead set **At (Attack)** to -99, the Attack time will get much shorter at higher velocities.

When the AMS source is at its maximum value for instance, when **Velocity** is at 127, a setting of +8 will make the segment time almost twice as long and a setting of -8 will cut the segment time almost in half.

Decay [-99...+99]

This controls the depth and direction of the AMS modulation for the Decay time.

Slope [-99...+99]

This controls the depth and direction of the AMS modulation for the Slope time.

Release [-99...+99]

This controls the depth and direction of the AMS modulation for the Release time.

AMS2 Intensity and AMS3 Intensity

These select the second and third AMS sources, respectively, for controlling the EG's Time parameters. Each has its own intensities for Attack, Decay, Slope, and Release. The parameters of both AMS2 and AMS3 are identical to those of AMS1, above.

EG Display

This shows the shape of the EG that's specified by the P-AMP EG settings. The location of the selected parameter is shown.

✓ **9-1...3: FUNCTION**

- 0: **Write Program, Write/Initialize Program** see page 63
- 1: **Solo Setting** see page 63
- 2: **Compare** see page 64
- 3: **Auto Song Setup** see page 64
- 4: **Add to Favorite** see page 64
- 5: **Copy Oscillator** see page 64
- 6: **Swap Oscillator** see page 64
- 7: **Sync Both EGs** see page 65 (only ENVELOPE page)

For more information, please see the "Program: Function" section on page 63.

10: P-OSC LFO AMSource

Each of the Oscillators has two LFOs, which you can use to modulate the filter, amp, pitch, and many other parameters.

The two Oscillators also share a single Common LFO, similar to the global LFO on some vintage analog synths.

These pages let you set up all of the parameters for all five LFOs.

In the P-OSC LFO page you can adjust settings for the four LFOs of the oscillator; in the P-CMN LFO/KT page you can adjust settings for the common LFO.

10-1: 1.WAV (LFO1 Waveform)

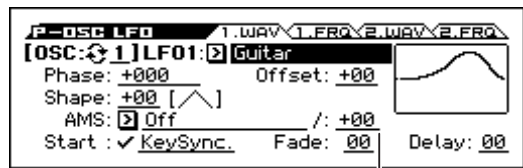

AMS Intensity

This page has all of the controls for the first LFO of Oscillator 1. For instance, you can:

- Select the LFO's basic waveform, and modify it with the **Shape** parameter.
- Control the LFO's frequency, and assign AMS controllers to modulate the frequency.
- Use the **Key Sync** parameter to choose whether the LFO runs separately for each voice, or is synchronized across all of the voices
- Use the **Fade** and **Delay** parameters to control how long the LFO waits to start after note-on, and whether it starts abruptly or fades in slowly.
- Set the LFO to sync to MIDI tempo.

OSC (Oscillator Select) [1, 2]

Select the oscillator (1 or 2) that you want to edit.

Note: Oscillator 2 can be selected if Oscillator Mode is set to Double.

LF01 (LF01) Waveform [Triangle...Random6 (Cont)]

This selects the basic LFO waveform, as shown in the graphic below.

Most of the waveforms should be self-explanatory, but a few will benefit from more details:

Guitar is intended for guitar vibrato, and its shape is specifically tuned for this purpose. The waveform is positive-only, so that when used for pitch, it will only bend up, and not down.

Random1 (S/H) generates traditional sample and hold waveforms, where the level changes randomly at fixed intervals of time.

Random2 (S/H) randomizes both the levels and the timing.

LFO waveform

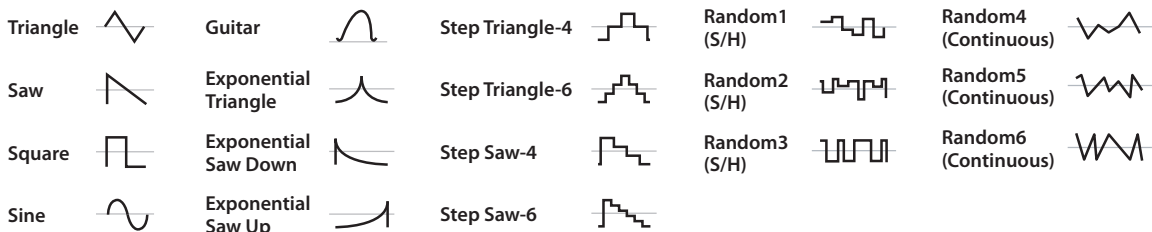

Random3 (S/H) generates a pulse wave with random timing. It's the opposite of traditional sample and hold; the timing varies, but the levels don't.

Random4-6 (Cont=Continuous) are smoothed versions of Random 1-3, with ramps instead of steps. You can use them to create more gentle random variations.

Phase (Start Phase) [-180...+180, Random]

This controls the phase of the waveform at the start of the note, in steps of 5 degrees.

If **Key Sync** is Off, the Start Phase will apply only to the first note of the phrase.

Offset [-99...+99]

By default, almost all of the LFO waveforms are centered around 0, and then swing all the way from -99 to +99. This parameter lets you shift the LFO up and down, so that for instance it's centered on 50, and then swings from -49 to +149.

For example, let's say that you're using an LFO for vibrato. If the **Offset** is 0, the vibrato will be centered on the note's original pitch, bending it both up and down.

If the **Offset** is +99, on the other hand, the vibrato will only raise the pitch above the original note.

Offset settings and pitch change produced by vibrato

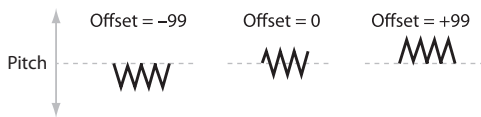

The one exception to this is the Guitar waveform, which is designed to emulate bending a string on a guitar so that the pitch only goes up, and not down. Because of this, the waveform is centered on 50, and not on 0. Of course, you can always use a negative **Offset** to shift it back down below 0 again!

Since the **Offset** affects the output values of the LFO, it's important to note that it affects the signal after the **Shape** function, as shown below:

How the LFO signal is affected by Shape and Offset

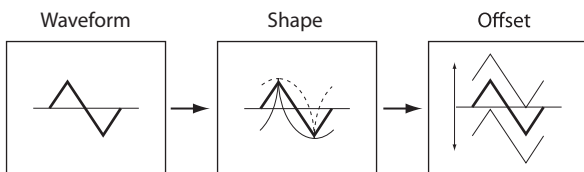

Shape [-99...+99]

Shape adds curvature to the basic waveform. As you can see in the graphic below, this can make the waveforms either more rounded or more extreme. It can also be useful to emphasize certain value ranges, and de-emphasize others.

For example, let's say that you are using a triangle LFO to modulate filter cutoff. If **Shape** emphasizes the high value range, the filter will spend more time at the higher frequencies. If it emphasizes the low range, the filter will spend more time at the lower frequencies.

LFO Shape

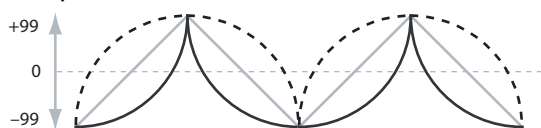

- Shape = 0 (original waveform)
- - - - Shape = +99
- Shape = -99

Note: **Shape** does **not** affect the Square and Random3 waveforms, since their values are always either +99 or -99. When these are selected, **Shape** is grayed out.

AMS (Shape) [List of AMS Sources]

This selects an AMS source for controlling the LFO's **Shape**. Modulating the shape can dramatically alter the effect of the LFO try it out!

For a list of AMS sources, please see "AMS (Alternate Modulation Source) List" on page 282.

AMS Intensity [-99...+99]

This controls the depth and direction of the **AMS (Shape)** modulation.

Start

Key Sync. [Off, On]

On (checked): When **Key Sync** is **On**, the LFO starts each time you press a key, and an independent LFO runs for each note. This is the normal setting.

Off (unchecked): When **Key Sync** is **Off**, the LFO starts from the phase determined by the first note in the phrase, so that the LFOs for all notes being held are synchronized together. The **Fade** and **Delay** settings will only apply to the first note's LFO.

Note that even if **Key Sync** is **Off**, each note's LFO speed may still be different if you modulate the Frequency by note number, velocity, key scaling, or other note-specific AMS sources.

Fade [00...99]

The LFO can fade in gradually, instead of simply starting immediately at full strength. This parameter specifies the time from when the LFO begins to play until it reaches its maximum amplitude.

If the **Delay** parameter is being used, then the fade will begin after the delay is complete.

When **Key Sync** is **Off**, the fade will apply only to the first note in the phrase.

LFO Fade and Delay

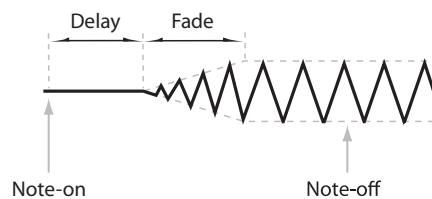

Delay [00...99]

This sets the time from note-on until the LFO starts.

When **Key Sync** is **Off**, the delay applies only to the first note of the phrase.

10-2: 1. FRQ (LFO1 Frequency)



OSC (Oscillator Select) [1, 2]

Select the oscillator (1 or 2) that you want to edit.

Note: Oscillator 2 can be selected if **Oscillator Mode** is set to **Double**.

LF01

Motion [Normal, Stop]

Specifies how the LFO will operate.

Normal: Normal operation. The LFO will operate according to the Frequency and other settings.

Stop: Instead of the LFO operating normally, it will ignore the **Frequency** setting. The LFO will maintain the initial value (determined by the combination of **Waveform**, **Phase**, **Shape**, and **Offset**) until the note-off.

Since the value will change only at note-on, using a Random waveform will produce a fixed value that changes randomly at each note-on (or at the first note-on).

Frequency Type [Manual, MIDI/Tempo Sync.]

Manual: The **Frequency** and **Frequency Modulation** settings will determine the speed of the LFO, and the tempo settings will have no effect.

MIDI/Tempo Sync: The LFO will synchronize to the system tempo, as set by either the TEMPO knob or MIDI Clock. The LFO speed will be controlled by the **Base Note** and **Times** parameters, below. All settings for **Frequency** and **Frequency Modulation** will be ignored.

Frequency Type: Manual

Frequency [00...99]

This controls the speed of the LFO, before any modulation. Higher values mean faster speeds, as shown in the table below.

By using AMS modulation, you can also get speeds much faster and much slower than what are available through this basic setting.

Frequency Value	Frequency in Hz
00	0.014 Hz
10	0.112 Hz
20	0.422 Hz
30	0.979 Hz
40	1.79 Hz
50	2.84 Hz
60	4.14 Hz
70	5.69 Hz
80	7.49 Hz
90	9.53 Hz
99	26.25 Hz
99 + Fine 99	32 Hz

AMS1 (Frequency) [List of AMS Sources]

This selects the first AMS source for the LFO1's frequency. For a list of AMS sources, please see "AMS (Alternate Modulation Source) List" on page 282.

Note that you can use LFO2 to modulate LFO1's frequency.

AMS Intensity [-99...+99]

This sets the initial amount of AMS1 (**Frequency**). The **Int Mod AMS** then adds to this initial amount.

When AMS is at its maximum value (for example by moving the modulation wheel fully away from yourself), the AMS affects the frequency as shown below:

Intensity	Change to LFO Frequency	
+99	64x	Faster
+82	32x	
+66	16x	
+49	8x	
+33	4x	
+16	2x	
-16	1/2x	Slower
-33	1/4x	
-49	1/8x	
-66	1/16x	
-82	1/32x	
-99	1/64x	

IntModAMS (Intensity Mod AMS) [List of AMS Sources]

This selects a secondary AMS source to scale the intensity of AMS1.

For a list of AMS sources, please see "AMS (Alternate Modulation Source) List" on page 282.

AMS Intensity [-99...+99]

This controls the depth and direction of the **IntModAMS**. Even if the main AMS1 Intensity is set to 0, **IntModAMS** can still control the final amount of AMS A over the full +/-99 range.

For example, if **AMS1** is set to the **Pitch EG**, and **IntModAMS** is set to **M.Wheel: #01**, **positive** settings mean that the intensity of the Pitch EG modulation of LFO Frequency will increase by moving the modulation wheel fully away from yourself.

AMS2 (Freq. AMS2) [List of AMS Sources]

This selects the second AMS source for the LFO1's frequency. For a list of AMS sources, please see "AMS (Alternate Modulation Source) List" on page 282.

AMS Intensity [-99...+99]

This controls the amount of modulation from **AMS2 (Freq. AMS2)**.

Frequency Type: MIDI/Tempo Sync.

If you've set the Frequency Type to MIDI/Tempo Sync, use the **Base Note** and **Times** parameters to specify a tempo-synchronized LFO speed.

Base Note (Sync. Base Note) [♩...]

This sets the basic speed of the LFO, relative to the system tempo. The values range from a 32nd note to a whole note, including triplets.

Times (Sync. Times) [x1...x32]

This multiplies the length of the **Base Note**. For instance, if the **Base Note** is set to a sixteenth note, and **Times** is set to **03**, the LFO will cycle over a dotted eighth note.

10-3: 2. WAV (LFO2 Waveform)

see “10-1: 1.WAV (LFO1 Waveform)” on page 39

10-4: 2. FREQ (LFO2 Frequency)

“10-2: 1. FRQ (LFO1 Frequency)” on page 41

✓ 10-1...4: FUNCTION

- 0: **Write Program, Write/Initialize Program** see page 63
- 1: **Solo Setting** see page 63
- 2: **Compare** see page 64
- 3: **Auto Song Setup** see page 64
- 4: **Add to Favorite** see page 64
- 5: **Swap LFO 1&2** see page 65

For more information, please see the “Program: Function” section on page 63.

11: P-CMN LFO/KT AMSSource

This is a single, Common LFO, global for all voices in the Program like the modulation LFOs in some vintage analog synths.

Differences from LFO1/2

The Common LFO starts running as soon as you select the Program, and only resets when you tell it to do so explicitly via the Reset Source control, below. This is different from LFO1/2’s **Key Sync** parameter, which resets whenever all notes are released.

The Common LFO’s persistence can be handy if you want to create a constant rhythm with an LFO, and then play “underneath” that rhythm without re-triggering it. For instance, you can use a MIDI controller in your sequencer to reset the Common LFO every few bars, regardless of what notes are being played.

The Common LFO has most of the same controls as LFO1/2. However, it does not include the **Delay, Fade, and Key Sync** settings, since these only make sense for per-voice LFOs.

11-1: LFO.W (Common LFO Waveform)



AMS Intensity

Common LFO (Common LFO Waveform)

[Triangle...Random6 (Cont)]

This selects the basic LFO waveform. For a complete list of the waveforms and more details, please see the entry under LFO1 “LFO1 (LFO1)Waveform” on page 39.

Phase [-180...+180, Random]

The **Reset AMS**, described above, lets you reset the Common LFO. This is the phase from which the LFO will start when it is reset.

Offset [-99...+99]

By default, almost all of the LFO waveforms are centered around 0, and then swing all the way from -99 to +99. This parameter lets you shift the LFO up and down, so that for instance it’s centered on 50, and then swings from -49 to +149.

For a complete description, please see the entry under LFO1 “Offset” on page 40.

Shape [-99...+99]

Shape adds curvature to the basic waveform. For more details, please see the entry under LFO1 “Shape” on page 40.

Note: Shape does **not** affect the Square and Random3 waveforms, since their values are always either +99 or -99.

AMS (Shape) [List of AMS Sources]

This selects an AMS source for controlling the LFO’s Shape. Modulating the shape can dramatically alter the effect of the LFO, try it out!

For a list of AMS sources, please see “AMS (Alternate Modulation Source) List” on page 282.

AMS Intensity [-99...+99]

This controls the depth and direction of the **AMS (Shape)** modulation.

Reset AMS

[List of AMS Sources]

This selects an AMS source to reset the LFO to the Start Phase. The LFO resets when the AMS value passes the halfway mark: +50 for most AMS sources, or 64 for MIDI controllers.

To create an effect similar to the per-voice LFO's Key Sync. setting, set this to **Gate 2+ Damper**.

11-2: LFO.F (Common LFO Frequency)

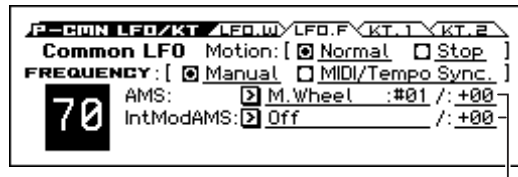

AMS Intensity

Motion

[Normal, Stop]

Specifies how the Common LFO will function.

Normal: Normal operation. The LFO will function according to the Frequency and other settings.

Stop: Instead of the LFO operating normally, it will ignore the **Frequency** setting. The LFO will maintain the initial value (determined by the combination of **Waveform**, **Phase**, **Shape**, and **Offset**) until the note-off.

Since the value will change only at note-on, using a Random waveform will produce a fixed value that changes randomly at each note-on (or at the first note-on).

Frequency Type

[Manual, MIDI/Tempo Sync.]

Manual: The **Frequency** and **Frequency Modulation** settings will determine the speed of the LFO, and the tempo settings will have no effect.

MIDI/Tempo Sync: The LFO will synchronize to the system tempo, as set by either the Tempo knob or MIDI Clock. The LFO speed will be controlled by the **Base Note** and **Times** parameters, below. All settings for **Frequency** and **Frequency Modulation** will be ignored.

Frequency Type: Manual

- Frequency** [00...99]
- AMS1 (Frequency)** [List of AMS Sources]
- AMS Intensity** [-99...+99]
- IntModAMS (Intensity Mod AMS)** [List of AMS Sources]
- AMS Intensity** [-99...+99]
- AMS2 (Freq. AMS2)** [List of AMS Sources]
- AMS Intensity** [-99...+99]

The parameters for the **Frequency type: Manual** are identical to those for LFO1 "Frequency Type:; Manual."

For more information, please see page 41

Frequency Type: MIDI/Tempo Sync.

- Base Note (Sync. Base Note)** [♩ ...]
- Times (Sync. Times)** [x1...x32]

The parameters for the **Frequency type: MIDI/Tempo Sync.** are identical to those for LFO1 "Frequency Type:; MIDI/Tempo Sync."

For more information, please see page 41

11-3: KT.1(Common Keyboard Track 1)

The two Oscillators share two Common keyboard tracking generators, in addition to each Oscillator's dedicated keyboard tracking for the Filter and Amp. You can use these Common keytracks as AMS sources for modulating most AMS destinations. The Common Keyboard Track parameters are shared by the entire Program, but the actual AMS values are calculated individually for each voice.

What does Keyboard Tracking do?

At its most basic, keyboard tracking lets you vary the modulation amount as you play up and down the keyboard. This can be useful for making the timbre consistent across the entire range, or adjusting parameters according to pitch.

The KROSS keyboard tracking can be fairly complex, if desired. You can create different rates of change over up to four different parts of the keyboard. For instance, you can:

- Make the modulation increase very quickly over the middle of the keyboard, and then increase more slowly or not at all in the higher octaves.
- Make the modulation increase as you play lower on the keyboard.
- Create abrupt changes at certain keys, for split-like effects.

Common Keyboard Tracking

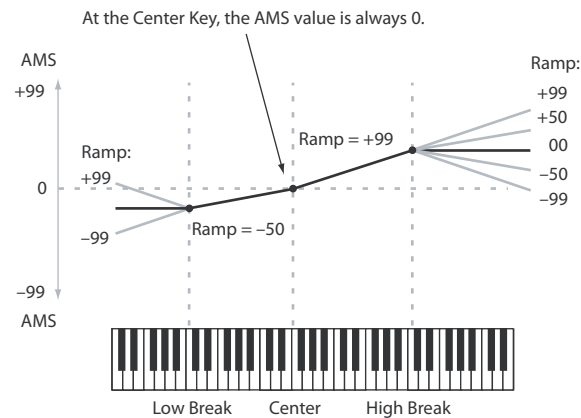

For more information, please see the “6-5: KTRK (Keyboard Track)” section on page 26.

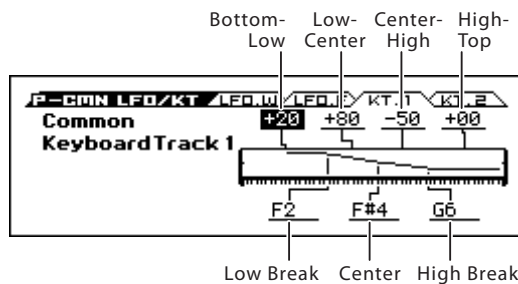

Key

Low Break [C-1...G9]

This specifies the note that will be the break point connecting the two sloped lines in the low region.

Center [C-1...G9]

This specifies the note that will be the break point in the center of keyboard tracking. At this **key**, the keyboard tracking has no effect on the AMS destinations.

High Break [C-1...G9]

This specifies the note that will be the break point connecting the two sloped lines in the high region.

Tip: You can also set the note value by the keyboard (see page 12 of the Operation Guide).

Ramp

Positive ramp values mean that the keyboard tracking output increases as you play farther from the **Center Key**; negative ramp values mean that it decreases.

Because of this, the meanings of positive and negative **Ramp** settings will change depending on whether the ramp is to the left or right of the **Center Key**.

Bottom-Low and Low-Center: negative ramps make the keyboard tracking's output go down as you play lower on the keyboard, and positive ramps make the output go higher.

Center-High and High-Top: negative ramps make the keyboard tracking's output go down as you play higher on the keyboard, and positive ramps make the output go up.

Bottom-Low [-Inf, -99...+99, +Inf]

This sets the slope between the bottom of the MIDI note range and the **Low Break** key. For normal key track, use negative values.

Low-Center [-Inf, -99...+99, +Inf]

This sets the slope between the **Low Break** and **Center** keys. For normal key track, use negative values.

Center-High [-Inf, -99...+99, +Inf]

This sets the slope between the **Center** and **High Break** keys. For normal key track, use positive values.

High-Top [-Inf, -99...+99, +Inf]

This sets the slope between the **High Break** key and the top of the MIDI note range. For normal key track, use positive values.

The table below shows how the **Ramps** affect the AMS output:

Ramp value	AMS change
-Inf	goes to -99 in 1 half-step
-99	-20 per octave
-50	-10 per octave
0	no change
+50	+10 per octave
+99	+20 per octave
+Inf	goes to +99 in 1 half-step

+Inf and -Inf ramps

+Inf and -Inf are special settings which create abrupt changes for split-like effects. When a ramp is set to +Inf or -Inf, the keyboard tracking will go to its extreme highest or lowest value over the span of a single key.

+Inf and -Inf Ramps

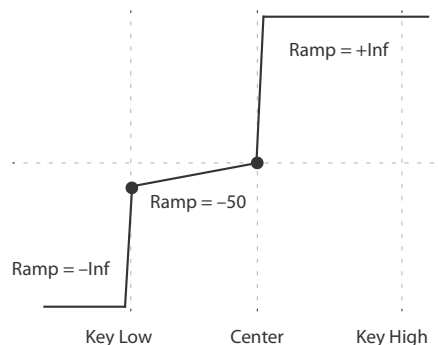

Note: If you set the **Center-High** ramp to +Inf or -Inf, the **High-Top** parameter will be grayed out. Similarly, if you set the **Low-**

Center ramp to +Inf or -Inf, the **Bottom-Low** ramp will be grayed out.

11-4: KT.2 (Common Keyboard Track 2)

Here you can adjust settings for the second common keyboard track.

For more information, please see the “11-3: KT.1(Common Keyboard Track 1)” section on page 44.

✓ 11-1...4: FUNCTION

- 0: **Write Program, Write/Initialize Program** see page 63
- 1: **Solo Setting** see page 63
- 2: **Compare** see page 64
- 3: **Auto Song Setup** see page 64
- 4: **Add to Favorite** see page 64

For more information, please see the “Program: Function” section on page 63.

12: P-AMS MIXER AMSource

Each Oscillator has two AMS Mixers, which are simple but powerful tools for combining and modifying AMS signals.

The two Oscillators also share two Common keyboard tracking generators, in addition to the dedicated keyboard tracking for the Filter and Amp.

These pages let you control all of these modulation sources.

Note that when the **Oscillator Mode** is set to **Single**, only Oscillator 1’s AMS Mixers are active; the pages for Oscillator 2 will be grayed out.

12-1: 1 (AMS Mixer1)

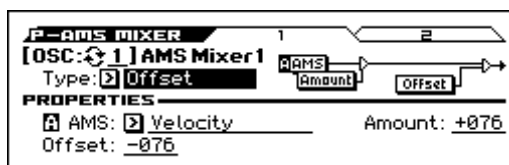

The AMS Mixers combine two AMS sources into one, or process an AMS source to make it into something new.

For instance, they can add two AMS sources together, or use one AMS source to scale the amount of another. You can also use them to change the shapes of LFOs and EGs in various ways, modify the response of realtime controllers, and more.

You can select the output of the AMS mixers as an AMS source in the same way as an LFO.

This also means that the original, unmodified inputs to the AMS Mixers are still available as well. For instance, if you use LFO1 as an input to an AMS Mixer, you can use the processed version of the LFO to control one AMS destination, and the original version to control another.

Finally, you can cascade the two AMS Mixers together, by using AMS Mixer 1 as an input to AMS Mixer 2.

OSC (Oscillator Select) [1, 2]

Select the oscillator (1 or 2) that you want to edit.

Note: Oscillator 2 can be selected if Oscillator Mode is set to Double.

Type (Mixer Type) [A+B, Amt Ax B, Offset, Smoothing, Shape, Quantize, Gate Control]

This controls the type of processing performed by AMS Mixer 1. Each of the Mixer Types is discussed in detail over the next several pages.

A+B adds two AMS sources together. For more information, please see the “A+B” section on page 46.

Amt Ax B scales the amount of one AMS source with the other. For more information, please see the “Amt Ax B” section on page 46.

Offset adds or subtracts a constant value to or from an AMS source. For more information, please see the “Offset” section on page 47.

Smoothing specifies the smoothness of movement between two values. You can use this to smooth sudden changes such as an abrupt movement of the modulation wheel or sharp angle of the LFO. For more information, please see the “Smoothing” section on page 47.

Shape adds curvature to the AMS input. For more information, please see the “Shape” section on page 47.

Quantize turns smooth transitions into discrete steps. For more information, please see the “Quantize” section on page 48.

Gate Control uses a third AMS source to switch between two AMS inputs (or a fixed value). For more information, please see the “Gate Control” section on page 49.

PROPERTIES

A+B

AMS Mixer, Type = A+B

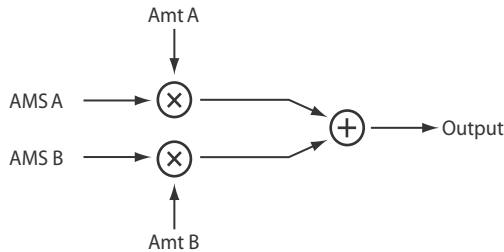

A+B merges two AMS sources into one. This can be handy when you need to add one more modulation source to a parameter, but you’ve already used up all of the available AMS slots.

For instance, let’s say that you’re using an LFO to modulate **Filter Resonance**, and then you decide that it would be interesting to scale that parameter with an EG as well. Resonance has only a single AMS input, but you can easily merge the LFO and the EG together using the A+B AMS Mixer:

1. Assign the LFO to AMS A.
2. Assign the EG to AMS B.
3. Assign the AMS Mixer as the Filter Resonance AMS source.

AMS Mixer A+B example

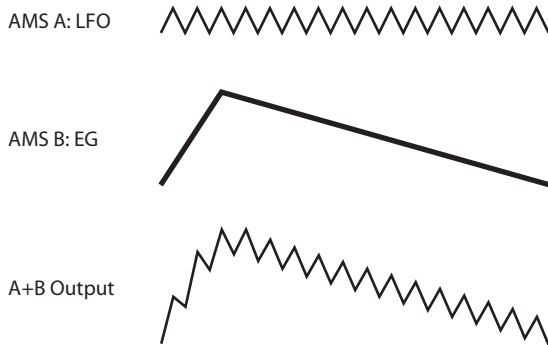

AMS A [List of AMS Sources]

This selects the first AMS input.
For a list of AMS sources, please see “AMS (Alternate Modulation Source) List” on page 282.

AMS A Amount [–99...+99]

This controls the depth and direction of the AMS A input.

AMS B [List of AMS Sources]

This selects the second AMS input.
For a list of AMS sources, please see “AMS (Alternate Modulation Source) List” on page 282.

AMS B Amount [–99...+99]

This controls the depth and direction of the AMS B input.

Amt AxB

AMS Mixer, Type =Amt A x B

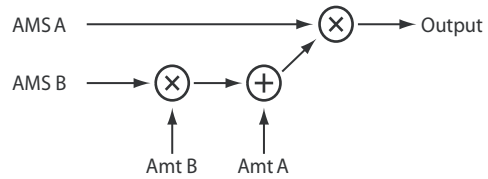

This Mixer Type uses AMS B to scale the amount of AMS A. For instance, you can control the amount of LFO1 with the Filter EG, or control the amount of the Pitch EG with the modulation wheel.

AMS Mixer Amt AxB example

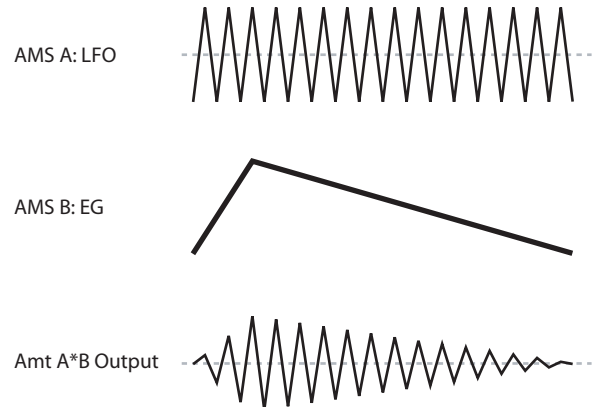

AMS A [List of AMS Sources]

This selects the first AMS source, which can then be scaled by AMS B.

For a list of AMS sources, please see “AMS (Alternate Modulation Source) List” on page 282.

AMS A Amount [–99...+99]

This controls the initial amount of AMS A, before modulation from AMS B. Input from AMS B then adds to this initial amount. Even if Amount A is set to 0, AMS B can still control the final amount of AMS A over the full +/-99 range.

AMS B [List of AMS Sources]

This selects the second AMS source, to scale the amount of AMS A.

For a list of AMS sources, please see “AMS (Alternate Modulation Source) List” on page 282.

AMS B Amount [–99...+99]

This controls the depth and direction of the AMS B modulation of AMS A.

For example, if **AMS A** is set to LFO1 and **AMS B** is set to the Filter EG, **positive** settings mean that the EG will increase the amount of LFO1.

Tip: use SW 1/2 to turn an AMS source on and off

You can use Amt AxB to “gate” an AMS source:

1. Set **AMS A** to the desired source, and set the **AMS A Amount** to 0.
2. Set **AMS B** to SW1 or 2, and **AMS B Amount** to +99.

Now, SW1 or 2 will turn AMS A on and off.

Offset

AMS Mixer, Type = Offset

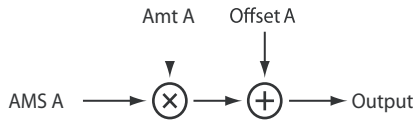

This simple processor adds a constant offset to the input, and also allows you to double the gain of an AMS source.

For instance, you can use this to convert a bipolar LFO (both negative and positive) to a unipolar LFO (positive only). To do this:

1. Select the LFO as the AMS A input.
2. Set the AMS A Amount to 50.

This cuts the overall level of the LFO in half, so that instead of swinging between -99 and +99, it only swings between -50 and +50.

3. Set the AMS A Offset to 50.

This adds 50 to the LFO level, so that it now swings between 0 and +99, as shown below.

AMS Mixer Offset examples

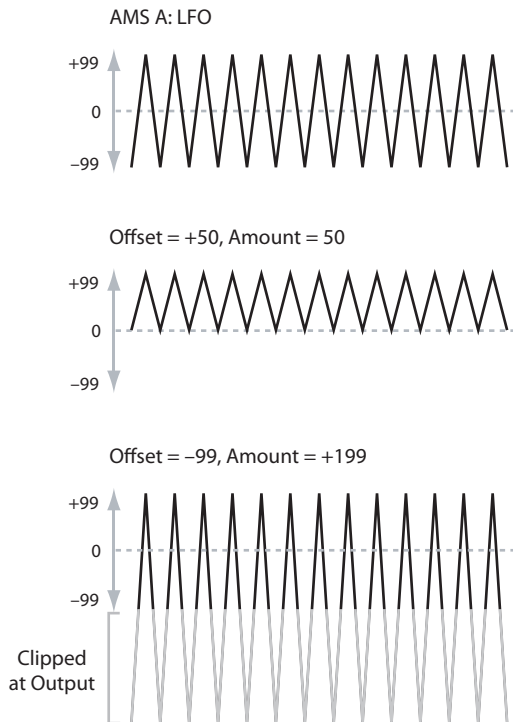

AMS A [List of AMS Sources]

This selects the AMS source to be offset.

For a list of AMS sources, please see “AMS (Alternate Modulation Source) List” on page 282.

AMS A Amount [-199...+199]

This controls the basic level of AMS A.

+199 doubles the original signal level, while -199 doubles the original signal level and inverts the phase. The values are clipped only at the output; internally, they can be greater than the normal range of -99 to +99.

AMS A Offset [-199...+199]

This controls the amount of offset for AMS A.

Setting Offset to +199 shifts an AMS input of -99 all the way to +99. In conjunction with high AMS A Amount values, this can be useful for creating clipped shapes, such as shown in the last of the “AMS Mixer Offset examples” above.

Smoothing

This Mixer Type smooths out the AMS input, creating more gentle transitions between values. You have separate control of the amount of smoothing during the attack (when the signal is increasing) and decay (when it’s decreasing).

The higher the Attack and Decay settings, the more the input will be smoothed.

Low settings provide subtle controller smoothing, creating more gradual aftertouch, for instance. Higher settings create auto-fade effects, transforming a quick gesture into a longer fade-in and/or fade-out event.

Smoothing can also be used to alter the shape of programmable mod sources, such as LFOs and EGs. For instance, you can turn a “blip” into a simple envelope shape, as shown below.

AMS Mixer Smoothing examples

Original AMS A: Smoothing with Long Attack and Short Decay:



Smoothing with Short Attack & Long Decay:



AMS A [List of AMS Sources]

This selects the AMS source to be smoothed.

For a list of AMS sources, please see “AMS (Alternate Modulation Source) List” on page 282.

AMS A Attack [00...+99]

This controls the attack time of the smoother, or how long it takes the smoother to reach a new, higher value.

Higher Attack settings mean longer times.

Depending on how quickly the AMS input value is changing, high Attack settings may mean that the value is never quite reached, as shown in “AMS Mixer Shape examples” above.

AMS A Decay [00...+99]

This controls the decay time of the smoother, or how long it takes the smoother to reach a new, lower value.

Higher Decay settings mean longer times.

Shape

This Mixer Type adds curvature to the AMS input. This applies deformation to the AMS input. You can use this to customize a controller curve, such as the exponential curve of the modulation wheel or the logarithmic curve of velocity control. It can also alter the shape of programmable modulation sources, such as EGs and LFOs.

Note: Shape only affects AMS signals which already have some amount of slope, such as EGs, triangle and sine LFOs, and so on. It does not affect signals which only contain abrupt transitions, such as square waves.

AMS A [List of AMS Sources]

This selects the AMS input source to be shaped.

For a list of AMS sources, please see “AMS (Alternate Modulation Source) List” on page 282.

Shape [-99...+99]

This controls the amount of curvature, and whether the curves are concave or convex. As you can see in the graphic examples, the shape will tend to emphasize certain value ranges, and de-emphasize others.

For example, let's say that you are using a triangle LFO, through **Shape**, to modulate filter cutoff. If **Shape** emphasizes the high value range, the filter will spend more time at the higher frequencies. If it emphasizes the low range, the filter will spend more time at the lower frequencies.

Mode [Symmetric, Asymmetric]

This selects whether the **Shape** parameter will produce one or two curves. The graphic "AMS Mixer Shape examples" may help to visualize how this works.

Asymmetric will produce a single curve, extending from -99 to +99.

Symmetric will produce two matching curves extending outwards from 0 to -99 and +99, respectively.

Bipolar and Unipolar AMS sources

To understand **Shape**, it helps to understand the difference between **bipolar** and **unipolar** AMS sources.

Bipolar sources can swing all the way from -99 to +99, with 0 in the middle. Most LFOs are bipolar, for instance; so is Pitch Bend.

Generally, bipolar AMS sources will work better with the **Asymmetric** mode, but **Symmetric** may also produce interesting results.

Unipolar sources only go from 0 to 99, with 50 in the middle. MIDI controllers, such as M.Wheel: #01, are all unipolar. In practice, EGs are usually programmed to be unipolar, even though the Filter and Pitch EGs do allow both positive and negative levels.

With unipolar sources, it's almost always better to use the **Symmetric** mode. The **Asymmetric** mode can cause offsets and other strange results.

AMS Mixer Shape examples

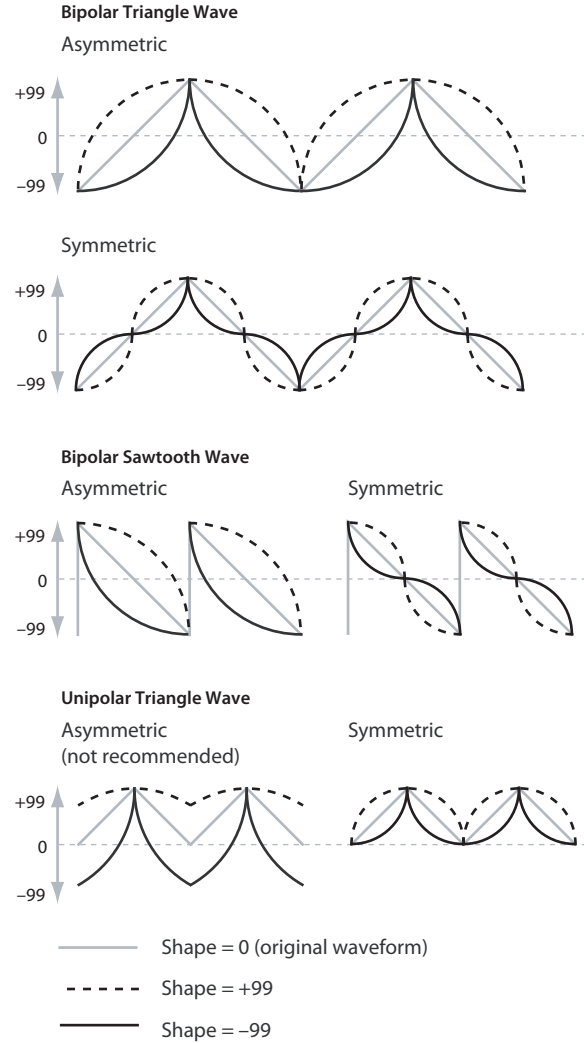

Quantize

This Mixer Type changes the input from a continuous signal into a series of discrete steps. Instead of moving smoothly between values, it will snap immediately from one value to another.

You can use this to change the shape of LFOs or EGs, or to force a controller to land on a few specific values.

AMS Mixer Quantize examples

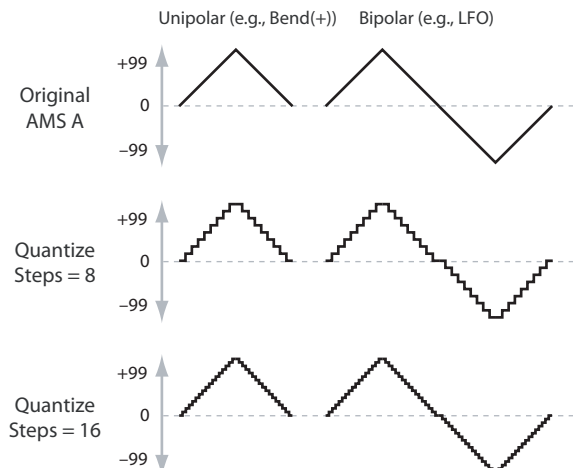

AMS A [List of AMS Sources]

This selects the AMS input source to be quantized.

For a list of AMS sources, please see “AMS (Alternate Modulation Source) List” on page 282.

Number Of Steps [2...32]

This controls the severity of the effect. The lower the number of steps, the more “steppy” the output will be.

For instance, when this is set to 2, there will be “steps” at 0, 50, and 99. With a bipolar AMS input, there will also be steps at -50 and -99.

As another example, when it is set to 5, there will be steps at 0, 20, 40, 60, 80, and 99 (as well as -20, -40, -60, -80, and -99 for bipolar inputs).

Tip: Quantized pitch bend wheel Pitch Bend

You can use the pitch bend wheel to create quantized pitch bends that simulate sliding across the frets of a guitar, or jump-bend sounds caused by differences in the length of the tube of a trumpet. To do so:

1. Select the AMS Mixer as the Oscillator Pitch AMS input.
2. Set the Pitch AMS Intensity to any exact half-step value, such as +5.00, +7.00, etc.
3. Set the Bend(+X), Bend(-X) amount to 0.00.
4. In the AMS Mixer, select the Pitch Bend as AMS A.
5. Set the Number Of Steps to the same number you used in Step 2.

Now, playing the pitch bend wheel will create quantized pitch bends.

Gate Control

AMS Mixer, Type = Gate Control

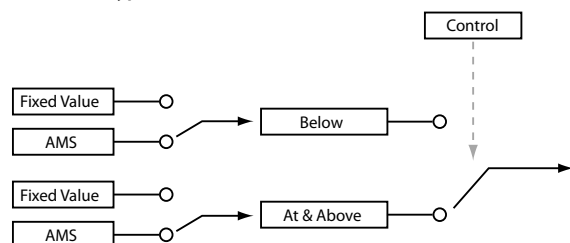

This Mixer Type lets you set up two different AMS sources (or fixed AMS amounts), and then switch between the two using a third AMS source.

It’s similar to an audio gate with a side-chain, but with even more flexibility since you get to choose what happens when the gate is closed (below the threshold), as well as when it’s open (above the threshold).

You can also choose whether the gate will be able to open and close continuously in response to the control source, or whether it only opens or closes at the beginning of the note, and then stays that way over the note’s entire duration.

You can use the Gate to:

- Use a foot-switch (or other controller) to apply pitch-bend or other effects to some notes, but not to others
- The parameter will be applied when the controller reaches a specific threshold. For example, the velocity value could control the filter resonance only if the velocity value exceeds 90.
- Use the modulation wheel, switches, or controllers to change between two separate LFOs (or other AMS sources).

Gate Control Source [List of AMS Sources]

This selects the AMS source to control the gate.

Control At Note-On Only [Off, On]

When this is enabled (checked), the value of the **Control Source** at note-on will select the output (**Below Threshold** or **At & Above Threshold**). The selected output will then remain active throughout the duration of the note, regardless of any subsequent change in the **Control Source**’s value.

Note that the output value itself can continue to change; only the selection of **Below** or **At & Above** is fixed.

Threshold [-99...+99]

This sets the value of the **Control Source** where the gate opens or closes.

Gate Output

If the value of the **Control Source** is less than the **Threshold**, the Gate outputs the preset value or AMS source selected under **Below Threshold**.

If the value of the **Control Source** is greater than or equal to the **Threshold**, the Gate outputs the preset value or AMS source selected in the **At & Above Threshold** parameter.

Below Threshold [Fixed Value, AMS A]

This selects whether **Below Threshold** uses a preset value, or the selected AMS source.

Fixed Value [-99...+99]

This lets you set a specific value to be used when the **Control Source** is less than the **Threshold**. This only applies when **Below Threshold** is set to **Fixed Value**.

AMS A [List of AMS Sources]

This lets you set an AMS source to pass through the Gate when the **Control Source** is less than the **Threshold**. This only applies when **Below Threshold** is set to **AMS A**.

At & Above Thresh (At & Above Threshold) [Fixed Value, AMS B]

This selects whether **At & Above Threshold** uses a preset value, or the selected AMS source.

Fixed Value [-99...+99]

This lets you set a specific value to be used when the **Control Source** is greater than or equal to the **Threshold**. This only applies when **At & Above Threshold** is set to **Fixed Value**.

AMS B [List of AMS Sources]

This lets you set an AMS source to pass through the Gate when the **Control Source** is greater than or equal to the **Threshold**. This only applies when **At & Above Threshold** is set to **AMS B**.

Tips on using the Gate

Selective pitch-bend, using a switch

You can use **Control At Note-On Only** to apply an effect to some notes, but not others, based on the state of an AMS source at the start of the note. For instance:

1. Set the **Control Source** to **Foot SW: CC#82**
(Connect a foot switch, and set the G-INPUT/CTRL> FOOT page Foot SW Assign parameter to Foot Switch (CC#82).)
2. Set **Control At Note-On Only** to **On** (checked).
3. Set the **Threshold** to **50**.
4. Set **Below Threshold** to a **Fixed Value** of **+00**.
5. Set **At & Above Threshold** to **AMS B: Pitch Bend**
6. On the **OSC Pitch** page, assign the **AMS Mixer** to control the pitch.
7. Turn off the foot switch, and while holding down a chord, move the pitch bend wheel. The pitch will not change.

(If the pitch changes, go to the OSC Pitch page and set Pitch Bend(+X) and Bend(-X) to +00.)

8. Turn on the foot switch, and add a new note to the previous chord.
9. Move the pitch bend wheel; pitch bend will be applied only to the newly-played note.

The new note will bend, but the original chord (played before you pressed on the foot-switch) will not.

Selective pitch-bend, using only the pitch bend wheel

You can also use a single AMS source as both the Control Source and a value source:

1. Set the Control Source to Pitch Bend.
2. Set Control At Note-On Only to On (checked).
3. Set the Threshold to 00.
4. Set Below Threshold to AMS A: Pitch Bend.
5. Set At & Above Threshold to a Fixed Value of 00.
6. On the OSC Pitch page, assign the AMS Mixer to control the pitch.
7. With the pitch bend wheel in the center, play a chord, and hold it through step 9.
8. Turn the pitch bend wheel toward yourself, and add a new note to the previous chord.

(If the pitch changes, go to the OSC Pitch page and set Pitch Bend(+X) and Bend(-X) to +00.)

9. Use the pitch bend wheel to bend the pitch of the new note.

This method is particularly good for bending the top note of a chord up to pitch.

Generating a static value

Sometimes, it can be handy to have a preset value as an AMS source. The Gate is one way to create this. To do so:

1. Set both Below Threshold and At & Above Threshold to Fixed Value, and enter the same value into each.

Now, the AMS mixer will always generate this static value.

12-2: 2 (AMS Mixer2)

This is the second AMS Mixer for Oscillators. The parameters are exactly the same as those for AMS Mixer 1, as described under “12-1: 1 (AMS Mixer1)” on page 45.

✓ 12-1, 2: FUNCTION

- 0: Write Program, Write/Initialize Program see page 63
- 1: Solo Setting see page 63
- 2: Compare see page 64
- 3: Auto Song Setup see page 64
- 4: Add to Favorite see page 64
- 5: Copy Oscillator see page 64
- 6: Swap Oscillator see page 64

For more information, please see the “Program: Function” section on page 63.

13: P-ARP (Arpeggiator)

Here you can adjust settings for the arpeggiator used by the program.

You can adjust settings so that when you select a program, these arpeggiator settings will automatically switch to the arpeggiator settings that are memorized in the selected program. (Global>SYSTEM page “Load ARP when changing Program” on page 157)

The arpeggiator can be switched on/off by the ARP button. When on, the button’s LED will light up.

The ARP button on/off status and the tempo can also be saved for each individual program.

Note: The parameters below that are marked with “*” can also be edited in “PROG> ARP”

These settings will be valid when “Load ARP when changing” **Program** (Global>SYSTEM page) is checked.

You can control the arpeggiator from an external sequencer, or record note data generated by the arpeggiator onto an external sequencer. (see page 76 of the Operation Guide)

Note: **Pattern**, **Resolution**, **Octave**, **Sort**, **Latch**, **Key Sync.**, **Keyboard**, and **Tempo** can also be set from the PROG> ARP page.

13-1: SETUP



Pattern* [Preset: UP...RANDOM, 0000...1027]

Selects the arpeggio pattern.

Preset/User No	Contents
Preset: UP...RANDOM	Preset arpeggio patterns
0000...0915	Preloaded arpeggio patterns
0916...1027	User arpeggio patterns

Note: 0000-1027 are rewritable. Use Global ARP PATTERN to create arpeggio patterns.

Example: Preset pattern

The way that the pattern is played will depend on settings such as **Octave** and **Sort**. The preset in the following diagrams show how the arpeggio will be played when **Octave** is set to 1, and **Sort** is checked. Preset: RANDOM is only one possibility.

Preset: UP

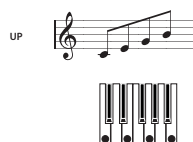

Preset: DOWN

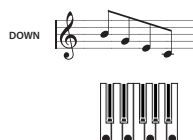

Preset: ALT1

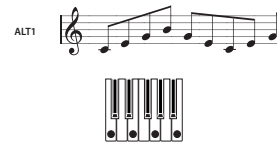

Preset: ALT2

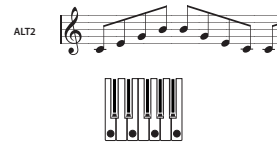

Preset: RANDOM

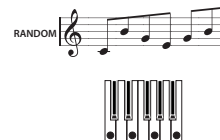

Octave* [1, 2, 3, 4]

Specifies the number of octaves where the arpeggio will be played.

If a user arpeggio pattern is selected, the range of the arpeggio will depend on the **Octave Motion** (page 169) setting.

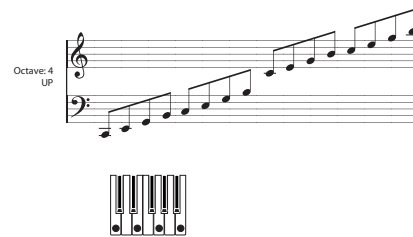

Resolution* [♪, ♪, ♫, ♩, ♪♩, ♪♩♩, ♪♩♩♩]

Specifies the timing resolution of the arpeggio. The notes of the arpeggio will be played at the interval you specify: ♪, ♪♩, ♪♩♩, ♪♩♩♩, ♪♩♩♩♩, or ♪♩♩♩♩♩. The speed of the arpeggio pattern is determined by the Arpeggiator **Tempo** and the **Resolution**.

Gate [000...100(%), Step]

Specifies the length (gate time) of each note in the arpeggio.

000-100(%): Each note will be played with the specified gate time.

Step: This is available when a user arpeggio pattern 0000-1027 is selected for **Pattern**. When this is selected, the gate time specified for each step will be used.

You can also use MOD [GATE] to control this. When the value is +00, the gate length will be as specified here.

Velocity [001...127, Key, Step]

Specifies the velocity of the notes in the arpeggio.

001-127: Each note will sound with the specified velocity value.

Key: Each note will sound with the velocity value where it was actually played.

Step: This is available when a user arpeggio pattern between 0000-1027 is selected for **Pattern**. When this is selected, the velocity specified for each step will be used.

You can also use MOD [VELOCITY] to control this. When the value is +00, the velocity value will be as specified here.

When a preload user arpeggio pattern is selected, setting the **Gate** or **Velocity** to Step will add a sense of groove to the arpeggio pattern.

Swing [-100...+100(%)]

This adjusts the timing for the step numbers that are specified by Steps per Beat for Swing.

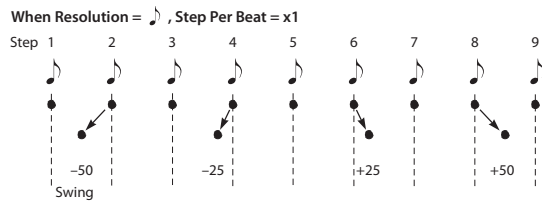

You can also use PROG> ARP page MOD [SWING] to control this.

Note: Swing has no effect on the preset patterns.

Sort* [Off, On]

This specifies the order that the notes you press will be arpeggiated.

On (checked): Notes will be arpeggiated in the order of their pitch, regardless of the order that you pressed them.

Off (unchecked): Notes will be arpeggiated in the order that you pressed them.

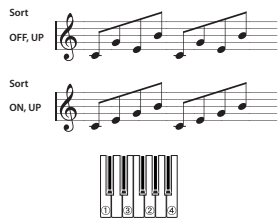

Latch* [Off, On]

Specifies whether or not the arpeggio will continue playing after you take your hand off of the keyboard.

On (checked): The arpeggio will continue playing after you remove your hand from the keyboard.

Off (unchecked): The arpeggio will stop when you remove your hand from the keyboard.

Key Sync.* [Off, On]

Specifies whether the arpeggio pattern will begin when you press a key, or whether it will always follow the \downarrow (Tempo) (PROG> MAIN).

On (checked): The arpeggio pattern will start playing from the beginning when a note-on occurs from a condition where no keys are pressed. This setting is suitable when you are playing in realtime and want the arpeggio to play from the beginning of the measure.

Off (unchecked): The arpeggio pattern will always play according to the \downarrow (Tempo).

Keyboard* [Off, On]

This specifies whether the notes you play on the keyboard will be sounded as usual in addition to being sounded as part of the arpeggio.

On (checked): The notes you play will be sounded on their own, in addition to being sounded as part of the arpeggio. For example if you simultaneously press two or more notes, they will be sounded as usual in addition to being played as arpeggiated notes.

Off (unchecked): Only the arpeggiated notes will be heard.

Note: You can use the FUNCTION Copy Arpeggiator to copy arpeggiator settings from another program or combination (see page 65).

13-2: SCAN ZONE

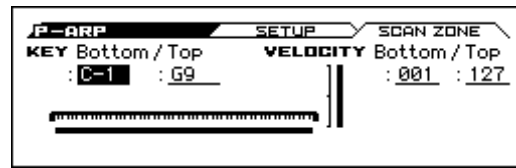

KEY

This shows the Scan Zone setting.

Bottom (Bottom Key) [C-1...G9]

Top (Top Key) [C-1...G9]

These parameters specify the range of notes (keys) where the arpeggiator will function. **Top Key** is the upper limit, and **Bottom Key** is the lower limit.

The arpeggiator will operate when you play keys within the specified range. Keys outside of this range can be played in the normal manner, and will not be affected by the arpeggiator.

For example if you set **Pattern** to Preset., check **Latch**, set **Top Key** to B3, and **Bottom Key** to C-1, playing a note B3 or lower will trigger the arpeggiator. Since **Latch** is on, the arpeggio will continue even after you release the keys. You can use the C4 and higher keys to play conventionally along with the arpeggio sounded by the B3 and lower keys. To change the arpeggio, play keys in the range of B3 and below.

VELOCITY

Bottom (Bottom Velocity) [001...127]

Top (Top Velocity) [001...127]

Specifies the range of velocities where the arpeggiator will function. **Top Velocity** is the upper limit, and **Bottom Velocity** is the lower limit.

The arpeggiator will operate when you play notes with a velocity (playing strength) that is within the specified range. Notes played with a velocity outside this range will be sounded normally, without regard to the arpeggiator.

Note: You can also set the note value and velocity value by the keyboard (see page 12 of the Operation Guide).

13-1, 2: FUNCTION

- 0: **Write Program, Write/Initialize Program** see page 63
- 1: **Solo Setting** see page 63
- 2: **Compare** see page 64
- 3: **Auto Song Setup** see page 64
- 4: **Add to Favorite** see page 64
- 5: **Copy Arpeggiator** see page 65

For more information, please see the "Program: Function" section on page 63.

14: P-DRUM TRACK

Here you can adjust settings for the Drum Track used by the program.

14-1: PATTERN

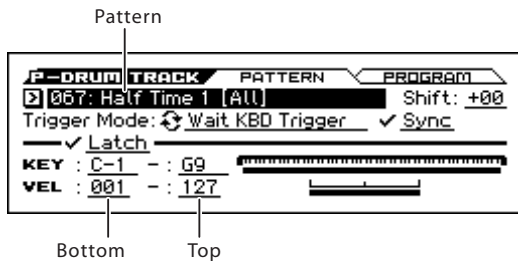

Here you can select a drum track pattern and specify how it will sound.

MIDI In Program mode, the drum track patterns are triggered on the Global MIDI channel. The MIDI transmit channel is specified by the DrumTrack **Prog MIDI Ch** (G- MIDI> OUT). Use the DrumTrack **Prog MIDI Out** (G- MIDI> OUT) setting to specify whether the pattern will transmit MIDI note data. The default setting is channel 10. The drum track program will not transmit or receive MIDI program changes.

Pattern [000, 001...700]

This selects the drum pattern.

Preset/User No.	Contents
000	Off
001...700	Preset drum patterns

Shift [-24...+00...+24]

This transposes the drum pattern in semitone steps. This means that the instruments of the drum kit will change.

Tip: If you've selected a GM drum program for the Drum Track, you should set this to -12.

Trigger Mode [Start Immediately, Wait KBD Trigger]

Start Immediately: When you press the DRUM TRACK button to turn it on (LED lit), the drum track pattern will start according to the **Sync** setting. When you turn it on, the drum track pattern will stop.

Wait KBD Trig: When you press the DRUM TRACK button to turn it on (LED lit), the drum pattern will wait to start. When you play the keyboard, or when a MIDI note-on is received, the drum pattern will start according to the **Sync** setting.

 If you've selected **Start Immediately**, the DRUM TRACK button will always be saved in the OFF state.

Sync [Off, On]

Off: The drum pattern will not synchronize to the currently-running arpeggiator or step sequencer, but will start immediately.

On: The drum pattern will synchronize to the currently-running arpeggiator or step sequencer.

Note: If you want the drum pattern to synchronize to the arpeggiator, set the P-ARP> SETUP page Arpeggiator Setup Key Sync parameter.

Latch [Off, On]

This specifies whether the drum track will continue playing even after you take your hand off the keyboard.

This setting is available if **Trigger Mode** is set to Wait KBD Trig.

Off: The pattern will stop when you take your hand off the keyboard (i.e., when all notes are off).

On: The pattern will continue playing until the DRUM TRACK button is turned off (LED unlit), regardless of whether you are performing via the keyboard or via MIDI.

KEY

Bottom (Keyboard Bottom) [C-1...G9]

Top (Keyboard Top) [C-1...G9]

This is valid if **Trigger Mode** is set to **Wait KBD Trig**.

It specifies the range of keys that will start the drum pattern.

VEL (Velocity)

Bottom (Velocity Bottom) [001...127]

Top (Velocity Top) [001...127]

This is valid if **Trigger Mode** is set to **Wait KBD Trig**.

It specifies the range of velocities that will start the drum pattern.

Note: You can also set the note value and velocity value by the keyboard (see page 12 of the Operation Guide).

14-2: PROGRAM

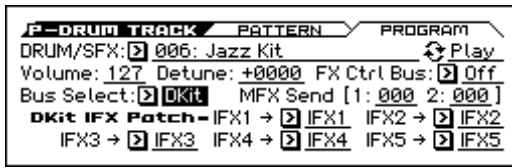

DRUM/SFX (Program Select) [DRUM /SFX, Category Programs]

Here you can select the drum program that will be used by the drum track.

Note: Only programs of the DRUM/SFX category can be selected.

If data is loaded or a system exclusive message is received so that the selected program is no longer a Drum category program, it will be replaced with the program of the Drum category.

The drum track program will not transmit or receive MIDI program changes.

Play/Mute [Play, Mute]

This mutes the drum track program. The setting will alternate each time you press the Play/Mute button.

Play: The drum track program will be heard (Play).

Mute: The drum track program will not be heard (Mute).

Volume [000...127]

This adjusts the volume of the drum track program.

Note: You can use the 0-3: MIXER page to edit the **Play/Mute**, **Solo On/Off**, and **Volume** settings of the drum track. (see “0-3: MIXER (Play Mixer)” on page 4)

Detune [-1200...+1200]

This adjusts the pitch in one-cent steps. One cent is 1/100th of a semitone.

The pitch of each drum kit is specified in Global DRUM KIT.

FX Ctrl Bus (FX Control Bus) [Off, FC1, FC2]

This sends the output of the drum track program to the FX Control bus (two mono channels FX Ctrl1, 2).

The FX Control bus is used when you want to use another audio signal to control the input of an effect. You can use the two FX Control buses (two mono channels) to freely control the effects in a variety of ways. For more information, please see the “FX Control Bus” section on page 199.

Bus Select [Dkit, L/R, IFX1...5, Off]

This specifies the bus that will output the drum track program.

Dkit: The **Bus Select**, **FX Control Bus**, **MFX Send1**, and **MFX Send 2** settings (Global DRUM KIT> VOICE page) for each key of the drum kit used by the selected drum track program will be valid. Choose this setting if you want to apply separate insert effects to each drum instrument.

Note: When making Dkit settings, you will normally use **Dkit IFX Patch** to specify the output destination.

L/R: Output to the L/R bus.

IFX1, 2, 3, 4, 5: Output to the IFX1-5 bus.

Off: The sound will not be output to the L/R bus, or IFX1-5 bus. Use the Off setting if you have connected the drum track program output in series to a master effect. Use **Send1 (to MFX1)** or **Send2 (to MFX2)** to adjust the send level.

1 (MFX Send 1) [000...127]

2 (MFX Send 2) [000...127]

These specify the send level where the output of the drum track program will be sent to each master effect.

Send 1: Send the signal to master effect 1.

Send 2: Send the signal to master effect 2.

If **Bus Select** is set to IFX1-5, the send levels to the master effects are set by the post-IFX1-5 **Send1** and **Send2** (P-FX ROUTING> MIXER).

You can use CC#93 to control **MFX Send 1**, and CC#91 to control **MFX Send 2**.

DKit IFX Patch

IFX1 [L/R, IFX1...5, Off]

IFX2 [L/R, IFX1...5, Off]

IFX3 [L/R, IFX1...5, Off]

IFX4 [L/R, IFX1...5, Off]

IFX5 [L/R, IFX1...5, Off]

Here you can patch the **Bus Select** setting specified for each key of the drum kit, temporarily changing its connection destination from the originally specified insert effect to some other destination. This can be executed only if the drum track program’s **Bus Select** is set to DKit and the **Bus Select** (Global DRUM KIT> VOICE page) for each key of the drum kit is set to IFX1-5.

As the patch destination, choose an insert effect or L/R, IFX1-5, or Off as the output bus.

Note: If you want to return the drum kit to its previous state, change these settings to IFX1→IFX1, IFX2→IFX2, IFX3→IFX3, IFX4→IFX4, and IFX5→IFX5.

The preload kits typically assign snare sounds to IFX1, kick sounds to IFX2, cymbal sounds to IFX3, and toms, percussion, and other sounds to IFX4. In such cases if you set **Bus Select** to Dkit, these sounds will be sent to IFX1, IFX2, IFX3 and IFX4, but IFX1 and IFX2 are set for normal (non-drum) programs. In such cases, you can use **Dkit IFX Patch** to route these drum sounds to unused IFX; for example, you might send the snare sounds to IFX3, kick sounds to IFX4, and other sounds to IFX5. For more information, please see the “Effect Guide” section on page 197.

✓ 14-1, 2: FUNCTION

- 0: **Write Program, Write/Initialize Program** see page 63
- 1: **Solo Setting** see page 63
- 2: **Compare** see page 64
- 3: **Auto Song Setup** see page 64
- 4: **Add to Favorite** see page 64
- 5: **Copy Drum Track** see page 64

For more information, please see the “Program: Function” section on page 63.

15: P-STEP SEQ (Step Sequencer)

Here you can adjust settings for the step sequencer that are used by the program.



x2: Swing will be applied to steps 3, 7, 11, 15 ... For example if you set Resolution to 1/8 and enter an 8-beat rhythm, the swing effect will be applied to the 8-beat.

x4: Swing will be applied to steps 5, 13, 21, 29 ... For example if you set Resolution to 1/8 and enter an 8-beat rhythm, the swing effect will be applied to the 8-beat.

(See illustration on the next page)

Step Sequencer Preview

This shows a graphic of the step sequencer pattern.

15-1: BASIC

Program [000...040]

Here you can select the drum program that will be used by the step sequencer.

Note: Only drum programs can be selected.

If the specified number is no longer a drum program because PCG data was loaded or SysEX data was received, it will be replaced by the first drum program.

The step sequencer program will not transmit or receive MIDI program changes.

Tempo [40.00... 300.00, EXT]

See “Tempo” on page 2.

Resolution [1/8, 1/4, 1/2, 3/4, 1, 2, 3, 4]

Specifies the timing resolution of the step sequencer. The notes of the pattern will be played at the interval you specify: 1/8, 1/4, 1/2, 3/4, 1, or 2. The speed of the step sequencer is determined by the Tempo and the Resolution.

Length [01...64]

Specifies the number of steps to play; in other words, the length of the pattern. Playback will repeat in the range of these steps.

Step/Bt (Steps per Beat for Swing) [x1, x2, x4]

Specifies the steps where the swing effect will be applied. The amount of the swing effect is specified by the P-STEP SEQ> MOD page Swing parameter.

x1: Swing will be applied to the even-numbered steps 2, 4, 6, 8 ...

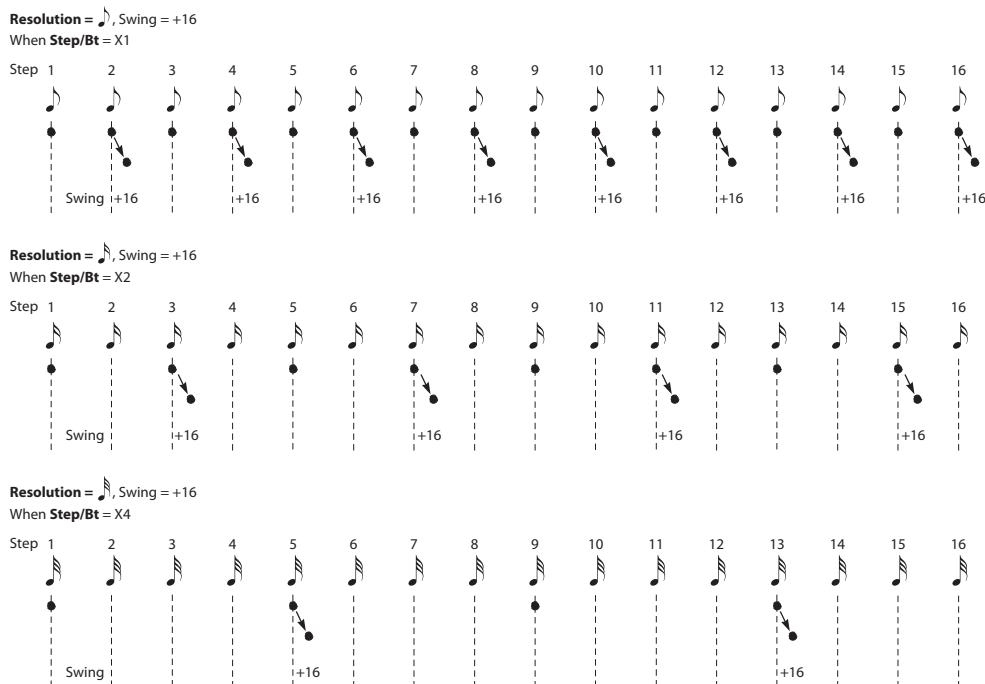

15-2: EDIT

front panel 1-16 buttons to turn steps on/off

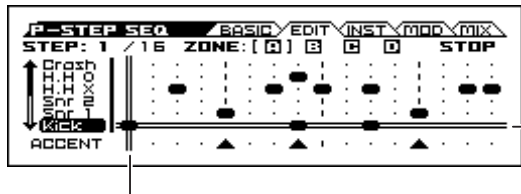

When you turn RUN on, the indication will move to the left, showing the currently-playing step.

ACCENT

[Off, On]

Specifies an accent for the step. (see “To add an accent to a step” on page 82 of the Operation Guide)

STEP SEQ - SETUP button

This page appears when you press the front panel STEP SEQ SETUP button.

The step on/off status of front panel buttons 1-16 is linked with the indication in this page.

STEP */* [1...64/01...64]

This shows the position and Length of the step that's selected in this page.

ZONE [A, B, C, D]

The currently-shown zone is indicated by [].

This is linked with the lit status of the front panel A/B/C/D LEDs.

A/B/C/D indicate the following ranges of steps.

A: Steps 1-16

B: Steps 17-32

C: Steps 33-48

D: Steps 49-64

STATUS [STOP, RUN]

Indicates whether the step sequencer is stopped (STOP) or running (RUN).

TONE 01 (Kick/Note No.) [Step Off, On]

TONE 02 (Snr 1/Note No.) [Step Off, On]

TONE 03 (Snr 2/Note No.) [Step Off, On]

TONE 04 (H.H X/Note No.) [Step Off, On]

TONE 05 (H.H O/Note No.) [Step Off, On]

TONE 06 (Crash/Note No.) [Step Off, On]

TONE 07 (Ride/Note No.) [Step Off, On]

TONE 08 (Tom L/Note No.) [Step Off, On]

TONE 09 (Tom H/Note No.) [Step Off, On]

TONE 10 (Perc 1/Note No.) [Step Off, On]

TONE 11 (Perc 2/Note No.) [Step Off, On]

TONE 12 (SFX/Note No.) [Step Off, On]

Turn the steps of each tone on/off. You can use the 1-16 buttons or the ENTER button to turn steps on/off. (see “Entering a pattern” on page 81 of the Operation Guide)

If you want to change the sound (instrument) of each tone, adjust settings in the P-STEP SEQ> INST page or use the Assign Inst to Tone function. The note number is shown if you've selected ALL for this setting, and the group name or abbreviation is shown if you've selected GROUP.

You can also specify velocity and accent on/off for each step. Use the Edit Step Parameters function to adjust this setting.

15-3: INST (Instrument)

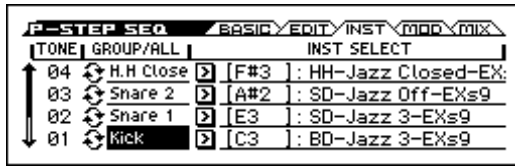

TONE 01 GROUP/ALL	[Kick, ALL]
TONE 02 GROUP/ALL	[Snare 1, ALL]
TONE 03 GROUP/ALL	[Snare 2, ALL]
TONE 04 GROUP/ALL	[H.H Close, ALL]
TONE 05 GROUP/ALL	[H.H Open, ALL]
TONE 06 GROUP/ALL	[Crash, ALL]
TONE 07 GROUP/ALL	[Ride, ALL]
TONE 08 GROUP/ALL	[Tom L, ALL]
TONE 09 GROUP/ALL	[Tom H, ALL]
TONE 10 GROUP/ALL	[Perc 1, ALL]
TONE 11 GROUP/ALL	[Perc 2, ALL]
TONE 12 GROUP/ALL	[SFX, ALL]

This specifies the type of instruments that can be selected in INST SELECT. If you select ALL, your choice of any instrument of the drum kit selected in the P-STEP> BASIC page can be assigned to the tone. If you select GROUP, you'll be able to choose an instrument from the corresponding group of the drum kit.

You can also select a tone by holding down the front panel STEP SEQ SETUP button and pressing on the 1-16 button.

INST SELECT **[Group, All]**

Assign an instrument for each tone. This shows the note number and the name of the drum sample that's assigned by the drum kit to DS1 of that note. The instruments that you can choose will depend on the TONE GROUP/ALL setting.

If because of the drum kit's settings there are no instruments in the corresponding group for a tone, you won't be able to choose INST SELECT (the screen will indicate "No Items!"). In this case, the instrument specified for All will be sounded by that tone.

Note: Tone Group settings are made for each instrument (note) of the drum kit, using the Global mode DRUM KIT> VOICE page Inst Type parameter.

Tip: You can also use the Assign Inst to Tone function to assign an instrument.

15-4: MOD (Modulation)



MODULATION CONTROLS

Velocity **[-64...+0...+63]**

Increases or decreases the velocity values for the entire step sequencer. The velocity value of each step is specified by the Edit Step Parameters function.

Swing **[-64...+0...+63]**

Specifies the amount of swing that is applied to the steps. This adjusts the timing for the step numbers that are specified by Steps per Beat for Swing.

Accent **[-64...+0...+63]**

Increases or decreases the amount of accent for steps whose accent is turned on.

Values in the range of +01...+63 will raise the velocity for steps whose accent is on.

Values in the range of -01...-64 will lower the velocity for steps whose accent is on.

15-5: MIX (Mixer)



Program [000...040]

Here you can select the program that will be used by the step sequencer.

Note: Only drum programs can be selected.

If data is loaded or a system exclusive message is received so that the selected program is no longer a Drum category program, it will be replaced with the first program of the Drum category.

The step sequencer program will not transmit or receive MIDI program changes.

Play/Mute [Play, Mute]

This mutes the drum program. The setting will alternate each time you press the Play/Mute button.

Play: Play: The drum program will be heard.

Mute: The drum program will not be heard (Mute).

Volume [000...127]

This adjusts the volume of the drum program.

Detune [-1200...+1200]

This adjusts the pitch in one-cent steps. One cent is 1/100th of a semitone.

The pitch of each drum kit is specified in Global DRUM KIT.

FX Ctrl Bus (FX Control Bus) [Off, FC1, FC2]

This sends the output of the drum program to the FX Control bus (two mono channels FX Ctrl1, 2).

The FX Control bus is used when you want to use another audio signal to control the input of an effect. You can use the two FX Control buses (two mono channels) to freely control the effects in a variety of ways. For more information, please see the “FX Control Bus” section on page 199.

Bus Select [Dkit, L/R, IFX1...5, Off]

This specifies the bus that will output the drum program.

Dkit: The **Bus Select**, **FX Control Bus**, **MFX Send1**, and **MFX Send 2** settings (Global DRUM KIT> VOICE page) for each key of the drum kit used by the selected drum program will be valid. Choose this setting if you want to apply separate insert effects to each drum instrument.

Note: When making Dkit settings, you will normally use **Dkit IFX Patch** to specify the output destination.

L/R: Output to the L/R bus.

IFX1, 2, 3, 4, 5: Output to the IFX1-5 bus.

Off: The sound will not be output to the L/R bus, or IFX1-5 bus. Use the Off setting if you have connected the drum program output in series to a master effect. Use **Send1 (to MFX1)** or **Send2 (to MFX2)** to adjust the send level.

1 (MFX Send 1) [000...127]

2 (MFX Send 2) [000...127]

These specify the send level where the output of the drum program will be sent to each master effect.

Send 1: Send the signal to master effect 1.

Send 2: Send the signal to master effect 2.

If **Bus Select** is set to IFX1-5, the send levels to the master effects are set by the post-IFX1-5 **Send1** and **Send2** (P-FX ROUTING> MIXER).

You can use CC#93 to control **MFX Send 1**, and CC#91 to control **MFX Send 2**.

DKit IFX Patch

IFX1 [L/R, IFX1...5, Off]

IFX2 [L/R, IFX1...5, Off]

IFX3 [L/R, IFX1...5, Off]

IFX4 [L/R, IFX1...5, Off]

IFX5 [L/R, IFX1...5, Off]

Here you can patch the **Bus Select** setting specified for each key of the drum kit, temporarily changing its connection destination from the originally specified insert effect to some other destination. This can be executed only if the drum track program’s **Bus Select** is set to DKit and the **Bus Select** (Global DRUM KIT> VOICE page) for each key of the drum kit is set to IFX1-5.

As the patch destination, choose an insert effect or L/R, IFX1-5, or Off as the output bus.

Note: If you want to return the drum kit to its previous state, change these settings to IFX1→IFX1, IFX2→IFX2, IFX3→IFX3, IFX4→IFX4, and IFX5→IFX5.

For the preloaded kits, snare sounds are normally sent to IFX1, kick sounds to IFX2, and symbal sounds to IFX3, toms, pucussion, and other sounds to IFX4. In such cases if you set **Bus Select** to Dkit, these sounds will be sent to IFX1, IFX2, IFX3 and IFX4, but IFX1 and IFX2 are set for normal (non-drum) programs. In such cases, you can use **Dkit IFX Patch** to route these drum sounds to unused IFX; for example, you might send the snare sounds to IFX3, kick sounds to IFX4, and other sounds to IFX5. For more information, please see the “Effect Guide” section on page 197.

✓ 15-1...5: FUNCTION

- 0: **Write Program, Write/Initialize Program** see page 63
- 1: **Solo Setting** see page 63
- 2: **Compare** see page 64
- 3: **Auto Song Setup** see page 64
- 4: **Add to Favorite** see page 64
- 5: **Assign inst to Tone** see page 65
- 6: **Edits Step Parameters** see page 65
- 7: **Copy Step Seq** see page 65

For more information, please see the “Program: Function” section on page 63.

16: P-FX ROUTING

Here you can adjust settings for the insert effects. For instance, you can:

- Select the insert effects
- Route a sound to an insert effect
- Create detailed settings for insert effects

For more information, please see “Effect Guide” on page 197.

16-1: BUS

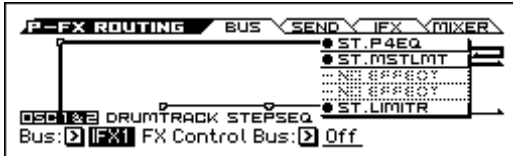

Routing Map

This graphic shows an overview of the insert effects.

Here you can view the status of the input bus to the insert effect **Bus Select**, the effect you're editing, and its on/off status and chain status.

This page lets you adjust the routing of the oscillators to the insert effects. To adjust the other settings shown in this graphic, please see “16-3: Insert FX Setup” on page 60.

Bus (Bus Select) [L/R, IFX1...5, Off]

This specifies the output bus for oscillators 1 and 2.

L/R: The oscillators will be output to the L/R bus. Normally you will choose L/R.

IFX1...5: Output to the IFX1–5 busses.

Off: The oscillator will not be output from the L/R bus, or IFX1–5. If you want the oscillator output to be connected directly to a master effect, turn this Off and use the SEND page parameters Send1 (to MFX1) and Send2 (to MFX2) to adjust the send levels.

FX Control Bus [Off, FC1, FC2]

Sends the output of oscillators 1, 2 to an FX Control bus (two-channel mono FX Ctrl 1 or 2).

Use the FX Control busses when you want a separate sound to control the audio input of an effect. You can use two FX Control busses (each is a two-channel mono bus) to control effects in various ways.

For more information, please see the “FX Control Bus” section on page 199.

DKIT-SET (Use DKit Setting) [Off, On]

This is shown and can be edited if the program's **Oscillator Mode** is set to Drums.

On (checked): The **Bus Select**, **FX Control Bus**, **Send 1**, and **Send 2** settings (Global DKIT> VOICE) for each key of the selected drum kit will be used. Check this if you want to apply an individual insert effect to each drum instrument.

Tip: In most preloaded drumkits, the drum instruments have the same **Bus Select** settings according to their type, as follows.

Snares → IFX1

Kicks → IFX2

Other → IFX3

Cymbals → IFX3

Toms, percussions, and other → IFX4

Off (unchecked): The sound is not output to the L/R bus or the IFX1–5 busses. Turn this Off if you want the output of the drum program to be connected directly to a master effect. Use **Send1 (to MFX1)** and **Send2 (to MFX2)** to adjust the send levels.

16-2: SEND

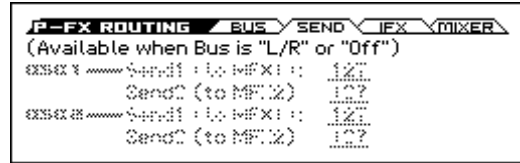

OSC1

Send1 (to MFX1) [000...127]

Sets the volume (send level) where the output of oscillator 1 will be sent to master effect 1. This applies only when **Bus Select** (P-FX ROUTING> BUS) is set to **L/R** or **Off**.

If **Bus Select** is set to **IFX1–IFX5**, the send levels to master effects 1 and 2 are set by **Send 1** and **Send 2** (P-FX ROUTING> MIXER) after passing through IFX1–5.

Send2 (to MFX2) [000...127]

Sets the volume (send level) where the output of oscillator 1 will be sent to master effect 2.

OSC2

Send1 (to MFX1) [000...127]

Send2 (to MFX2) [000...127]

Sets the volume (send level) where the output of OSC2 will be sent to master effects 1 and 2 (see “OSC1:”).

MIDI CC#93 controls OSC 1/2's Send 1 level, and CC#91 controls the Send 2 level. These are controlled on the global **MIDI Channel** (G-MIDI> BASIC). The actual send level is determined by multiplying these values with the send levels of each oscillator.

16-3: Insert FX Setup

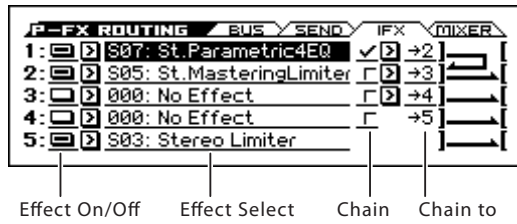

Here you can choose the type of each insert effect, 1 through 5, its on/off status, chaining, and adjust the post-IFX mixer settings.

For insert effects, the direct sound (Dry) is always stereo-in and out. The input/output configuration of the effect sound (Wet) depends on the effect type.

For more information, please see “Insert Effects (IFX1–IFX5)” on page 200.

1 (IFX1)

Effect On/Off [Off, On]

Switches the insert effect on/off.

If this is off, the input will simply be passed to the output. (When 000:No Effect is selected, there’s no difference between On and Off.)

Each time you select this and press the ENTER button, the insert effect will turn on or off.

MIDI Separately from this setting, you can use MIDI CC #92 (on the global **MIDI Channel** (G–MIDI> BASIC)) to turn all insert effects off. A value of 0 turns them off, and values of 1–127 restore the original setting.

Effect Select [000, S00...S63, D00...D10]

This selects the effect type for insert effect.

IFX5 cannot use double-size effects. If you use a double-size effect, the next insert effect will be unavailable. For example if you select a double-size effect for IFX1, you won’t be able to use IFX2.

IFX Select menu

You can also choose effect no.:Name and press the ENTER button to access the IFX Select menu, and select an effect from the list. Use the ▲ ▼ buttons or the VALUE dial to make a selection, and then press the ENTER button to confirm it.

Chain [Off, On]

This connects insert effects in series.

If **Chain** is On, this insert effect will be connected in series with the insert effect selected by **ChainTo**.

With the On setting, the upper line of the display shows the insert effect connection status.

Example: IFX1 **ChainTo**: IFX2

IFX1 **Chain**: On

Insert effects 1 and 2 will be connected in series. If **Bus Select** is set to IFX1, the oscillator’s output will be sent in series through IFX1 to IFX2. You can connect up to five insert effects (IFX1–IFX5) in series. In this case, the **Pan: #8 (CC#8)**, **Bus select**, **Fx Control Bus**, **Send1**, and **Send2** settings following the last insert effect will be used.

Chain to [2...5]

You can chain up to five insert effects together in series, to create more complex effects. Set up the chain using this parameter, and then enable it using the **Chain** check box.

Effects can also join a chain in the middle. For instance, you can chain IFX1 to IFX2 through IFX5, and IFX2 to IFX3 through

IFX5 as well. IFX4 does not provide a **ChainTo** setting. It can be connected only to IFX5. You can’t connect from IFX5 to another insert effect.

2 (IFX2)

Effect Select [000, S00...S61, D00...D10]

Effect On/Off [Off, On]

Chain [Off, On]

Chain to [3...5]

See “1 (IFX1):”

3 (IFX3)

Effect Select [000, S00...S61, D00...D09]

Effect On/Off [Off, On]

Chain [Off, On]

Chain to [4, 5]

See “1 (IFX1):”

4 (IFX4)

Effect Select [000, S00...S61, D00...D09]

Effect On/Off [Off, On]

Chain [Off, On]

See “1 (IFX1):”

5 (IFX5)

Effect Select [000, S00...S61]

Effect On/Off [Off, On]

See “1 (IFX1):”

16-4: MIXER

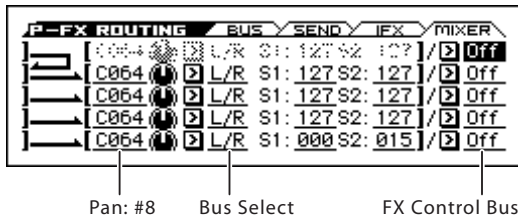

Here you can adjust the post-IFX mixer settings.

1 (IFX1)

Pan: #8 (CC#8) [L000...C064...R127]

Specifies the panning immediately after the insert effect.

MIDI You can use CC#8 to control this.

Bus Select [Off, L/R]

Specifies the bus where the signal will be sent immediately after the insert effect.

L/R: The signal will be sent to the L/R bus.

Off: The signal will not be sent directly to the L/R outputs. This setting is useful if you want to:

- Use **Send 1** or **Send 2** to route the signal entirely through the master effects, without sending the dry signal to the outputs.
- Use the **FX Control Bus** to route the signal to an effects side-chain, such as a gate or vocoder, without being heard directly at the outputs.

S1 (Send1) [000...127]

S2 (Send2) [000...127]

These adjust the level where the post-IFX signal is sent to master effects 1 and 2. This is valid if **Chain** is set to Off.

MIDI You can use CC#93 to control the Send 1 level, and CC#91 to control the Send 2 level. The global MIDI channel specified by **MIDI Channel** (G-MIDI> BASIC) is used for these messages.

FX Control Bus [Off, FC1, FC2]

Sends the post-IFX signal to the FX Control busses. For more information, please see the “FX Ctrl Bus (FX Control Bus)” section on page 54.

! If you’re using FX Control Bus as an input signal for Vocoder etc., a feedback loop will occur if you output to the same bus as specified here and oscillation will occur. Set this with care to avoid creating a loop.

2...5 (IFX2...5)

The parameters for for insert effects 2–5 are exactly the same as those for insert effect 1. See “1 (IFX1)” above.

✓ 16-1...4: FUNCTION

- 0: **Write Program, Write/Initialize Program** see page 63
- 1: **Solo Setting** see page 63
- 2: **Compare** see page 64
- 3: **Auto Song Setup** see page 64
- 4: **Add to Favorite** see page 64
- 5: **Copy Insert Effect** see page 66
- 6: **Swap Insert Effect** see page 66

For more information, please see the “Program: Function” section on page 63.

17: P-IFX

Here you can edit the parameters of the insert effect you selected in the P-IFX ROUTING> IFX page.

17-1: IFX1(Insert Effect1)

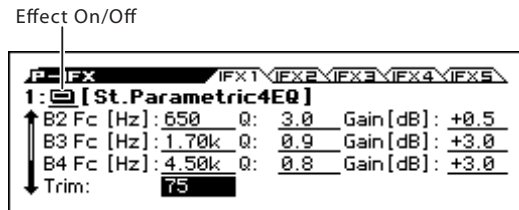

MIDI Effect dynamic modulation (Dmod) is controlled on the global **MIDI Channel** (G-MIDI> BASIC). For more information, please see the “Dynamic Modulation Source List” section on page 288.

Effect On/Off [Off, On]

This turns the insert effect on and off. It is linked with the on/off setting in the IFX page.

IFX1 Parameters

This tab shows the parameters for IFX1, as selected on the Insert FX Setup page.

For details on the specific parameters of each effect, please see page 207.

17-2: IFX2 (Insert Effect2),

17-3: IFX3 (Insert Effect3),

17-4: IFX4 (Insert Effect4),

17-5: IFX5 (Insert Effect5),

The parameters for IFX2–IFX5 are the same as for IFX1.

✓ 17-1...5: FUNCTION

- 0: **Write Program, Write/Initialize Program** see page 63
- 1: **Solo Setting** see page 63
- 2: **Compare** see page 64
- 3: **Auto Song Setup** see page 64
- 4: **Add to Favorite** see page 64
- 5: **Copy Insert Effect** see page 66
- 6: **Swap Insert Effect** see page 66

For more information, please see the “Program: Function” section on page 63.

18: P-MFX (Master Effect)

Here you can adjust settings for the master effects. For instance, you can:

- Select the effect type for master effect.
- Route a sound to a master effect.
- Create detailed settings for master effects.

For more information, please see “Effect Guide” on page 197.

18-1: SETUP

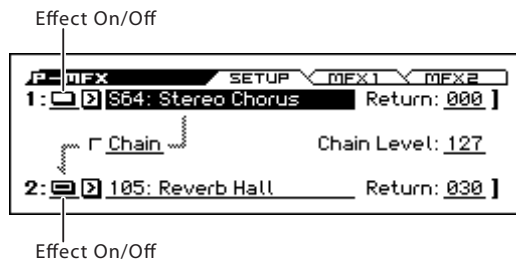

Here you can specify the type of master effects, and turn them on/off. The master effects are sent to the L/R bus.

The master effect does not output the direct sound (Dry). Adjust the **Return 1** and **Return 2** return levels to return the signal to the L/R bus and mix it with the L/R bus signal.

The master effects are stereo-in/out, but depending on the selected effect type, the output may be monaural. For more information, please see the “In/Out” section on page 200.

1 (MFX1)

Effect On/Off [Off, On]

Switches the master effect 1 on/off. When off, the output will be muted. This will alternate between on and off each time it is pressed.

Tip: An easy way to disable the master effects is to turn off the front panel MASTER FX button. MFX 1/2 will be temporarily disabled, and will stay off even if you switch programs or modes. When you turn the switch on, the master effects will be enabled, and you will obtain the effects specified by the program or combination.

Note: The MASTER FX button is linked with GLOBAL> SYSTEM page Effect Global SW MFX.

MIDI Separately from the settings here you can use control change #94 to turn master effects 1 and 2 off. A value of 0 turns them off, and values of 1–127 restore the original setting. The global MIDI channel specified by **MIDI Channel** (G-MIDI BASIC) is used for this message.

Effect Select [000, S01...S87, D00...D13]

This selects the effect type for master effect 1.

For master effect 1, only 000–D13: Early Reflections can be selected.

If you choose 000:No Effect, the output from the master effect is muted.

Return 1 [000...127]

This specifies the return level from the master effect to the L/R bus.

Chain [Off, On]

On (checked): Chain (series connection) will be turned on for MFX1 and MFX2.

Chain Level [000...127]

When chain is On, this sets the level where the sound is sent from MFX1 to MFX2.

If you select a double-size effect, the **Chain** settings will be ignored.

2 (MFX2)

Effect On/Off [Off, On]

Effect Select [000...120]

Here you can choose the type for master effect 2, and turn the effect on/off.

Return 2 [000...127]

These parameters specify the effect type for master effect 2, its on/off status, and the return level from master effect 2 to the L/R bus. For more information, please see “1 (MFX1)” above.

MFX2 cannot use double-size effects. Additionally, if you select a double-size effect for MFX1, you won't be able to use MFX2.

18-2: MFX1 (Master Effect 1)

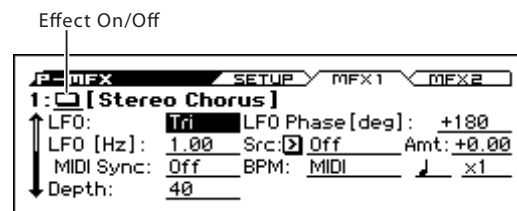

Here you can edit the parameters of the effect you choose for MFX1 in the P-MFX> SETUP page.

For details, Please see “Effect Guide” on page 197

18-3: MFX2 (Master Effect 2)

These pages let you edit the parameters of Master Effect 2. To select different effects types, use the P-MFX> SETUP page.

The parameters for MFX2 is the same as for MFX1. For more information, please see the “18-2: MFX1 (Master Effect 1)” section on page 62.

✓ 18-1...3: FUNCTION

- 0: **Write Program, Write/Initialize Program** see page 63
- 1: **Solo Setting** see page 63
- 2: **Compare** see page 64
- 3: **Auto Song Setup** see page 64
- 4: **Add to Favorite** see page 64
- 5: **Copy Master Effect** see page 66

For more information, please see the “Program: Function” section on page 63.

Program: Function

Procedure for each function

1. Press the **FUNCTION** button to open the function list.
2. Adjust settings in the dialog box.

For details on the settings in each dialog box, refer to the explanation of each function.

Press the **OK** button to execute, or press the **Cancel** button if you decide not to execute.

Write Program, Write/Initialize Program

Use these functions to save (write) an edited program to internal memory. You can also initialize a user bank program.

 Be sure to save a program that you want to keep. A program you've edited cannot be recovered if you turn off the power or select a different program before writing it into memory.

Writing

1. Select the program that you want to save.
2. Choose this function. Depending on the program bank that's selected, you'll be able to select the following functions.

If a bank A–D or G program is selected:

Write Program function

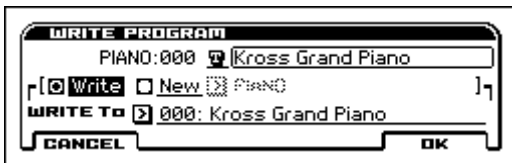

If a bank U program is selected:

Write/Initialize Program function



3. Specify the save-destination.

If you're using Write Program, choose either Write or New.

If you're using Write/Initialize Program, only New can be selected.

Write: You can save the sound to the same category within bank A–D. The category is fixed.

New: You can specify any category and save the sound in bank U 000–127.

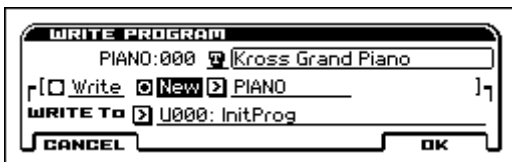

4. Note the program's category.
5. Select the save-destination in **WRITE To**. For limitations on the save-destination, please see step 3.
6. If you want to rename the program that you're saving, select the text edit button and press the **ENTER** button.

The text edit dialog box will appear. Enter the program name. (see "Editing names" on page 105 of the Operation Guide)

When you've finished entering the name, press the **OK** button to return to the Write Program dialog box.

7. To execute the Write procedure, press the **OK (MENU)** button.

To cancel without executing, press the **CANCEL** button.

Initialize

Here's how to initialize a program in bank U.

1. Select the bank U program that you want to initialize.
2. Choose this function (**Write/Initialize Program**).



3. Choose **Initialize**.

4. Choose **This/All**.

This: Only the selected program will be initialized.

All: All programs in bank U will be initialized.

5. To execute the Initialize procedure, press the **OK** button. To cancel without executing, press the **CANCEL** button.

Solo Setting

Here's how to turn Solo on/off for oscillators 1 and 2, the Drum Track, and the step sequencer.

1. Use the menu to select **Exclusive Solo**.

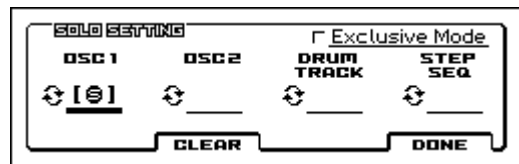

2. Select the item that you want to solo, and switch it on/off.
3. Pressing the **CLEAR** button will turn off solo for all items.
4. If **Exclusive Mode** is checked, the operation of the Solo function will change.

• **Not checked:** Multiple Solo

The specified OSC1, OSC2, drum track, or the step sequencer will be soloed. The solo on/off setting will alternate each time you press the Solo button.

• **Checked:** Exclusive Solo

Only one source - OSC1, OSC2, the drum track, or the step sequencer- will be soloed.

Note: The Solo function applies to each mode. All sources are handled as a single group. In the case of Exclusive Solo, all other sources will be off if even one source is being soloed.

5. Press the **Done** button to return to the previous page. Note the Solo and Mute status.

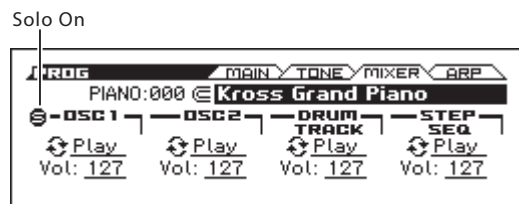

Tip: Solo takes priority over Mute.

Note: The Solo On/Off setting is not saved when you write the program.

Compare

Use this function when you want to compare the sound of the program you're editing with the sound prior to editing (i.e., the saved sound).

While editing a program, you can turn on the Compare function (select the check mark) to recall the settings that were last written to that program number. When you turn off the Compare function (clear the check mark), you will return to the settings that you had been editing.

1. While editing, select this function and turn it on (select the check mark).

The sound that had been saved before you began editing will be recalled.

2. When you turn off this function (clear the check mark), you will return to the sound that you had been editing.

Note: If you edit the settings that were recalled by turning Compare on (i.e., the saved settings), the check mark will be cleared, and your previously edited settings will be lost. Even if you turn Compare on again (select the check mark), the previous settings will not return.

 The Compare function is not available for editing that uses the Tone Adjust parameters.

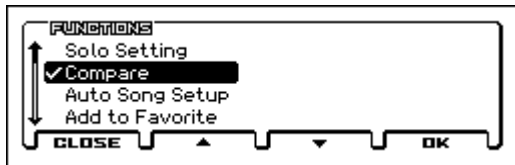

Auto Song Setup

This function automatically copies the settings of the program or combination to a song, and enables the record-standby condition (see "Auto Song Setup" on page 101).

Tips: You can also access and execute this function by pressing the REC (●) button.



Add to Favorite

This function adds the program that you've selected in Program mode (or the combination that you've selected in Combination mode) to Favorites.



1. In Program mode or Combination mode, select a sound. (see page 2, 70)

2. Choose this function to enter registration mode.

Tip: You can also enter registration mode by holding down the EXIT button and pressing the FAVORITES button.

3. Use the BANK button to select a bank.
4. Press one of the 1–16 buttons to register the sound to that button.

If you decide not to register the sound, press the EXIT button.

Hold Balance

1. Choose this function to turn it on (select the check mark).
2. When you adjust any volume setting, the other volume settings will change to maintain the balance. This is convenient when you want to adjust the overall volume.

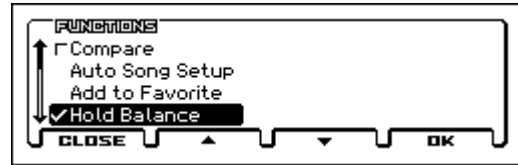

Copy Oscillator

Copy Oscillator is available on all of the tabs under the P–BASIC, P–OSC, P–PITCH, P–PITCH EG, P–FILTER, P–FILTER EG, P–AMP, P–AMP EG, and P–AMS MIXER pages.

This function is used to copy the settings from one oscillator to another.

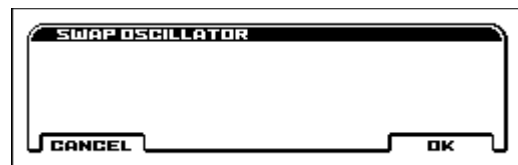

1. Use From to select the copy-source program.
2. Select the oscillator that you want to copy.
3. In To, specify the copy destination oscillator.

Swap Oscillator

Swap Oscillator is available on all of the tabs under the P–BASIC, P–OSC, P–PITCH, P–PITCH EG, P–FILTER, P–FILTER EG, P–AMP, P–AMP EG, and P–AMS MIXER pages.

This function exchanges the settings of oscillators 1 and 2.

Note: This can be selected only if Oscillator Mode (P–BASIC>VOICE) is Double.

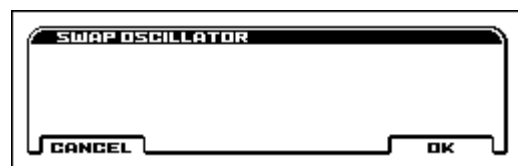

Copy Drum Track

Copy Drum Track is available on the P–DRUM TRACK page.

This function copies settings from the specified program, combination/timbre, or song.



1. Use the From field to select the mode, bank, and number of the desired copy-source. You can press a BANK button to select the desired bank.
2. If you use this function in Program mode, and select Program in From, the additional field Program Settings too will appear.

On (checked): The parameter settings of the DRUM TRACK> PATTERN page and PROGRAM page will be copied.

Off (unchecked): The parameter settings of the DRUM TRACK> PATTERN page will be copied.

If you perform this function in Combination or Sequencer mode, the parameter settings of the DRUM TRACK> PROGRAM page will be copied. However, the MIDI Channel setting will not be copied.

Sync Both EGs

Sync Both EGs is available on the P-FILTER EG> ENVELOPE and P-AMP EG> ENVELOPE pages.

This option allows you to edit the EGs of Oscillator 1 and Oscillator 2 together. When it is checked, editing the Filter EG of either Oscillator 1 or 2 will change both Filter EGs simultaneously. Similarly, editing the Amp EG of either Oscillator will change both Amp EGs.

This option is available when the Oscillator Mode is set to Double.

1. Choose this function to turn it on (select the check mark).

The display will indicate “SYNC BOTH EG’s” and the two EGs will be synchronized.

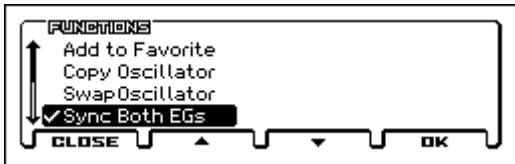

2. If you no longer want the EGs to be synchronized, select Sync Both EGs once again.

The indication will disappear from the display.

Swap LFO 1&2

Swap LFO 1 & 2 is available on all of the P-OSC LFO pages.

This function copies the settings of LFO1 to LFO2, and vice-versa.

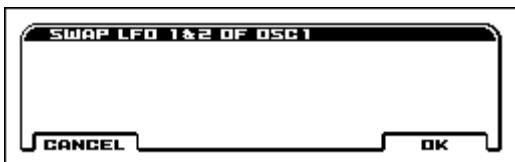

Note: If LFO2 is being used to modulate LFO1, this function will erase that modulation routing.

Copy Arpeggiator

Copy Arpeggiator is available on the PROG> ARP, P-ARP page.

This function can be used to copy arpeggio settings from another location to the current program.



1. Use From to select the copy-source.
2. If you are copying from Combination, or Song, specify whether you wish to copy from A or B.

Assign Inst to Tone

Here's how to assign an instrument to each tone of the step sequencer..

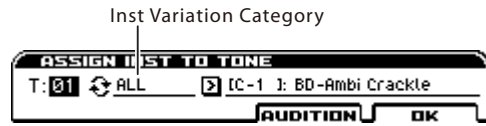

1. Choose this function.

Tip: You can also access this by holding down the SETUP button and pressing one of the 1–12 buttons of the desired tone to make the button light up, and then pressing the lit button again.

2. Use the “T” field to select the tone.

Tip: You can also switch tones by holding down the SETUP button and pressing one of the 1–12 buttons where the desired tone is assigned.

3. In the Inst Variation Category field, choose All or a category.

If All is selected, you'll be able to choose drum sounds from all instruments. If a category is selected, you'll be able to choose from instruments of that category.

Tip: If the Inst Variation Category is set to a category, switching programs may also cause the Inst Variation note number to be switched. This is because an instrument of the same category does not exist at the same note number as the program that you changed, and therefore a nearby instrument of the same category has been assigned automatically.

4. Select an instrument.

You can press the AUDITION button to hear the sound you selected.

Tip: You can also play the keyboard to hear the candidate instrument. If Inst Variation Category is set to All, all keys will produce sound. If a category is selected, sound will be produced only by the keys where a corresponding instrument has been assigned.

You can also select by holding down the SETUP button and playing a key.

5. When you've finished adjusting settings, press the OK button.

Edits Step Parameters

Here you can specify velocity and accent on/off for each step.



Copy Step Seq

This function copies the step sequencer settings from the program, combination, or song that you specify.



1. Choose this function.
2. Use the From field to select the copy-source mode and sound.
3. If you use this function from Program mode, and choose Program as the From setting, the Program Setting too option is displayed.

On (checked): The parameter settings of the STEP SEQ> BASIC–MIX pages will be copied.

Off (unchecked): The parameter settings of the STEP SEQ> BASIC–MOD pages will be copied (except for Program).

The on/off state of “Program Settings too” will affect only the settings of the MIX page.

If you're using this function in Combination or Sequencer mode, the settings of the STEP SEQ> MIX page parameters will be copied. However, the MIDI Channel setting will not be copied.

If you choose this function when the STEP SEQ on/off setting is Off, the STEP SEQ on/off setting will be forced On, and the various settings will be copied.

 If you've chosen Combination or Song in the From field, the Program will not be copied if the copy-source STEP SEQ on/off setting is Off.

Copy Insert Effect

Copy Insert Effect is available on the P–FX ROUTING and P–IFX pages.

This function copies effects settings from within the current Program, from other Programs, Combinations, or Songs.

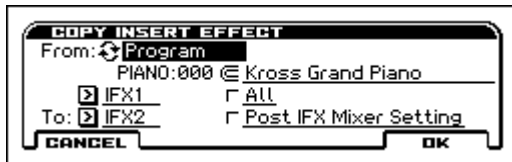

To execute the Copy Insert Effect function, press the OK button. To cancel, press the Cancel button.

 If you're copying from a master effect, the result will not be identical due to differences in the routing and level settings of the master effects.

From (Mode) [Program, Combination, Song]

This selects whether you'll copy from a Program, a Combination, or a Song.

From (Bank and Number) [Bank and Number]

For Programs and Combinations, this selects the Bank and Number from which to copy. When this parameter is selected, you can also use the front-panel BANK buttons to select Banks.

(Effects slot select) [IFX 1...5, MFX 1&2]

Select which of the effects you wish to copy.

You can also copy from a master effect.

All [check-box]

When this is enabled, the settings of all insert effects (the contents of the Insert FX page and the effect parameters of IFX1–5, but not **Ctrl Ch**) will be copied.

To [IFX 1...5]

This selects the insert effect copy destination.

Post IFX Mixer Settings [check-box]

When this is checked, the **Pan**, **Bus Select**, **FX Control Bus**, and **Sends 1 and 2** settings that follow the copy source insert effect will also be copied.

When this is not checked, only the effect type and its parameters will be copied.

Copying 000: No Effect

Copying a single effect set to “000: No Effect” will not work: no data will be copied.

If either **All** or **All used** is selected, and “000: No Effect” exists within a chain, it will be copied. However, if the entire chain consists of “000: No Effect,” nothing will be copied.

Swap Insert Effect

Swap Insert Effect is available on the P–FX ROUTING and P–IFX pages.

This function exchanges the effects, and their internal parameters, between two IFX slots.

All of the parameters shown on the IFX 1–5 pages will be copied.

Other IFX slot parameters will not be affected, including **Pan**, **Sends 1 and 2**, **Chain**, **AUX Bus**, and **FX Control Bus**.

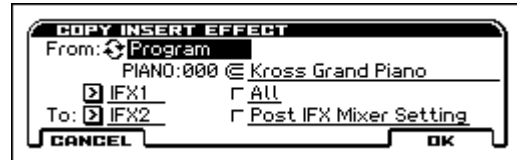

1. In Source 1 and Source 2, select each of the insert effects that you wish to swap.

Copy Master Effect

Copy Master Effect is available on the P–MFX pages.

This function lets you copy any desired effect settings from Program, Combination, or Song.

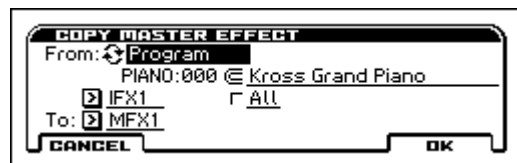

1. Use the From field to select the copy source mode, bank, and number.

You can also use the BANK buttons to select the desired bank.

2. Select the effect that you want to copy.

You can copy from an insert effect by selecting IFX1–5.

If you copy from an insert effect, the result may not be exactly the same, due to differences in routing and level settings.

If you select MFX1 or MFX2, the **Return** level will be copied at the same time.

If you check **All**, all master effect settings will be copied.

3. In To, specify the copy destination master effects.

Extended program functions

In addition to playing and editing programs, the KROSS provides several convenient extended program functions.

Quick Layer/Quick Split

Quick Layer is a function that makes it easy to set up a layer, letting you play two sounds that are layered together. You can also adjust the volume balance.

Quick Split is a function that lets you make split settings so that you can play different sounds on the left and right regions of the keyboard. You can select each of the two programs, and adjust their volume and octave.

Note: The sound you create will be saved as a combination.

Auto song setup

The Auto Song Setup function automatically copies the settings of a program or combination to a song, and makes the necessary settings to prepare for recording. This lets you instantly capture your phrases or musical ideas as a song. (see “Auto Song Setup” on page 101)

Audio input and audio recording

If you press the AUDIO IN button to turn on the audio input, you'll be able to play a program while singing into a mic or playing a vocoder program, or perform along with the playback from your audio player. (see page 5)

Combination mode

COMBI Page Select

Here's how you can select each page.

- Use the PAGE+/- buttons.
- Press the MENU button to access the page menu, use the PAGE+/- buttons to select a page, and press the MENU (OK) button or the ENTER button.
- While the above page menu is displayed, press the FUNCTION (TABS) button, then use the PAGE+/- buttons to select a page by its tab, and then press the MENU (OK) button or the ENTER button.
- Hold down the MENU button and press the PAGE- or PAGE+ buttons.

For details, see See “Selecting pages and tabs” on page 11 of the Operation Guide.

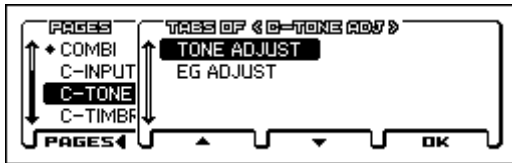

Page	Tabs	Main content
COMBI	MAIN	Select and play a combination (see page 70)
	PROG	Select a program for each timbre and set its status (see page 71)
	MIXER	Timbre volume, pan, and mute settings (see page 72)
	ARP	Arpeggiator easy editing (see page 73)
C-INPUT/CTRL	AUDIO IN	External audio input settings (see page 74)
	CONTROLLERS	SW1 and 2 function settings and tempo setting (see page 74)
C-TONE ADJ	TONE ADJUST	Tone Adjust settings for each timbre (see page 75)
	EG ADJUST	EG (ADSR) settings for each timbre (see page 76)
C-TIMBRE	MIDI	MIDI channel settings for each timbre (see page 77)
	OSC	OSC settings for each timbre (see page 77)
	PITCH	Pitch settings for each timbre (see page 78)
	SCALE	Scale selection (see page 78)
C-ZONE/DELAY	KEY ZONE	Key zone settings for each timbre (see page 79)
	VEL ZONE	Velocity zone settings for each timbre (see page 80)
	DELAY	Delay time settings for each timbre (see page 81)
C-FILTER	1, 2, 3, 4	MIDI transmit/receive filter settings for each timbre (see page 82)
C-ARP	ASSIGN	Arpeggiator assignments to each timbre (see page 84)
	A	Arpeggiator A settings (see page 85)
	B	Arpeggiator B settings (see page 85)
	SCAN ZONE	Arpeggiator trigger region settings (see page 85)
C-DRUM TRACK	PATTERN	Drum Track pattern selection and trigger region settings (see page 86)
	CHANNEL	Drum Track input/output MIDI channel settings (see page 87)
C-STEP SEQ	BASIC	Step sequencer program selection and length settings (see page 88)
	EDIT	Step on/off entry (see page 88)
	INST	Instrument settings (see page 89)
	MOD	Step sequencer settings such as accent and swing (see page 89)
C-FX ROUTING	BUS	Bus assignments from each timbre to the insert effects (see page 90)
	SEND	Send amounts from each timbre to the master effects (see page 91)
	IFX	Insert effect type selection and chain settings (see page 91)
	MIXER	Post-insert effect routing settings (see page 92)
C-IFX	IFX1, 2, 3, 4, 5	Insert effect 1-5 settings (see page 92)
C-MFX	SETUP	Master effect type selection and chain settings (see page 93)
	MFX1, 2	Master effect 1 and 2 settings (see page 94)

0: COMBI (Combination)

This is the main page for selecting and playing Combinations.

0-1: MAIN

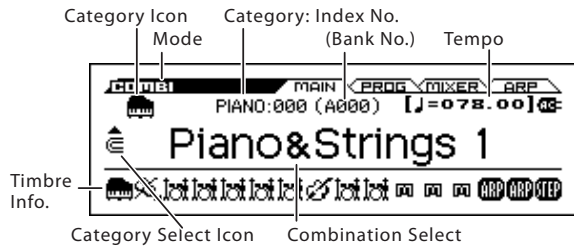

Category Icon [USE/GM, PIANO...DRUM/SFX]

This shows the combination's category icon. The USER category icon is shown at the left of the PIANO-DRUM/SFX icon.

Category [PIANO...USER]

This is the combination category name.

All combinations are organized into 11 preset categories and 1 user category.

PIANO, E.PIANO, ORGAN, BELL, STRINGS, BRASS, SYNTH LEAD, SYNTH PAD, GUITAR, BASS, DRUM/SFX, USER.

Index No. (Bank No.) [000... (A, B, U: 0...127)]

The index number sorts the programs of the A, B and U banks, starting from number 000.

The index number is the number that is used to transmit or receive MIDI program changes; it ranges from 0-127 for banks A, B and U. This also indicates the restrictions that apply when saving to each bank.

Category Select Icon

Where this icon appears, you can use the sound selector (CATEGORY dial, SELECT dial) to select a combination or a program.

Combination Select

This is the name of the selected combination.

Sound select list

This lists the combinations in each category. Select a combination and play it. Here's how to access this list and play a combination.

1. In the COMBI> MAIN page, the list will appear when you turn the CATEGORY dial or SELECT dial, or press the ENTER button.



2. If you want to switch to a different category, use the CATEGORY dial or the cursor buttons ◀ ▶.
3. To select sounds, use the SELECT dial, the value dial, or To select sounds, use the SELECT dial, the value dial, or the cursor buttons ▲ ▼.
4. If you return to the COMBI> MAIN page by pressing the OK (MENU) button, the sound you selected in step 3 will be selected. If you press the Cancel (FUNCTION) button, your selection will be cancelled, and the sound that had been selected before you opened the list will be selected.

Note: To change the category assignment of each combination, use the Write Combination dialog box.

To switch combinations

- Turn the value dial, or use the cursor buttons ▲ ▼.
- Use the sound selector list (see "Sound select list")
- You can use a foot switch to select programs. (see "Foot Switch Assign" on page 164 and "Foot Switch Assign List" on page 291)
- You can select programs by transmitting a MIDI Program Change from a connected external MIDI device.

Note: MIDI program changes are transmitted using the Bank No. shown in the screen.

J(Tempo) [40.00... 300.00, EXT]

This is the tempo for the current combination, which applies to the arpeggiator, drum track, step sequencer, tempo-synced LFOs, and tempo-synced effects.

040.00...300.00: Indicates the tempo.

In this page, you can adjust the tempo by turning the TEMPO knob or by pressing the TAP button at the desired interval. In the C-INPUT/CTRL> Controllers page you can enter a numeric value.

EXT is displayed if the **MIDI Clock** (G-MIDI> BASIC) is set to **External MIDI** or **External USB**. This is also shown if the **MIDI Clock** setting is Auto and MIDI clock data is being received from an external device. If the tempo source is EXT, the arpeggiator etc. will synchronize to MIDI clock data from an external MIDI device.

Timbre Info.

The following information is shown for each timbre.

- The category of the program etc. that's assigned to the timbre
COMBI> PROG page Status: when set to INT
COMBI> MIXER page Sound: when set to Play

Note: INT is shown if the User category is selected.

- Mute
- COMBI> PROG page Status: INT
COMBI> MIXER page Sound: when set to Mute
- Dummy arpeggiator (see page 138)
COMBI> PROG page Status: Off
C-ARP> ASSIGN page ARP Assign: when set to A or B
- Step sequencer
- COMBI> PROG page STEP SEQ On/Off: when set to On
- Status **OFF**
COMBI> PROG page Status: when set to Off, EXT, or EX2

Battery/AC Icon

Indicates the power supply and the remaining battery capacity. (see page 2)

0-2: PROG (Program)

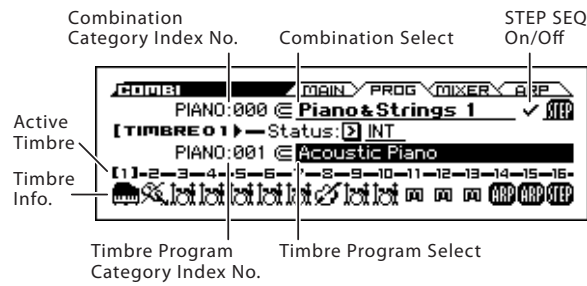

Combination Category: Index No. [PIANO...USER: 000..127]

Combination Select [000...127]

Here you can select a combination.

STEP SEQ On/Off [Off, On]

This specifies whether timbre 16 is used for the step sequencer or as a conventional timbre.

On (checked): Timbre 16 is used for the step sequencer. In this case, a drum program is assigned to timbre 16.

Off (unchecked): Timbre 16 is used as a conventional timbre.

If this is On, a drum program is assigned automatically. Even if you then turn this Off again, the drum program will still be assigned. Select the program that you want to use as a conventional timbre.

To switch combinations

- Choose **Combination Select** and turn the VALUE dial or use the cursor buttons ▲ ▼.
- Choose **Combination Select** and use the sound selector list (see “Sound select list” on page 70).

Timbre 01...16 (Timbre Number)

To select a timbre, place the cursor at one of the following parameters, and use the cursor buttons ◀ ▶ to switch timbres. The selected timbre is called the “active timbre,” and is indicated by square brackets [].

Status [Off, INT, EXT, EX2]

This sets whether the Timbre controls the internal sounds, or external MIDI devices.

Off: Use this to disable the Timbre. With this setting, the Timbre’s Program will not sound, and MIDI data will not be transmitted.

INT: This timbre will sound when you play the KROSS, and will also sound in response to MIDI messages from an external MIDI device. MIDI data will not be transmitted.

EXT: When you play the KROSS, this timbre will not produce sound; however, MIDI data will be transmitted to an external device.

EX2: Use this to play an external MIDI device, with custom-set **Bank Select** via the **Bank Select (When Status=EX2) LSB** and **MSB** parameters, on the C-TIMBRE> MIDI page. In all other ways, this is the same as EXT.

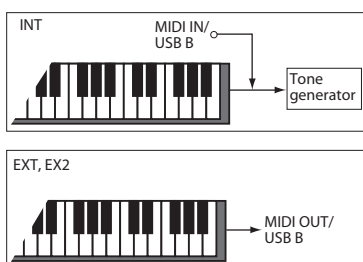

Timbre Program Category: Index No. [PIANO...USER: 000...127]

Timbre Program Select [Program name]

Here you can select the program for each timbre.

To switch programs

- Choose **Program Select** and turn the VALUE dial or use the cursor buttons ▲ ▼.
- Choose **Program Select** and use the sound selector list (see “Sound select list” on page 70).
- You can select programs by transmitting a MIDI Program Change from a connected external MIDI device.

Note: MIDI program changes are transmitted using the Bank No. specified in Program mode. This is a different number than the Category Index No. shown in this page. Please be aware of this. (see the separate “Voice Name List”)

The KROSS’s combinations and timbre programs can be switched from an external MIDI device by using MIDI bank select and MIDI program change messages.

By default, the combination bank and number will change when a bank select or program change message that matches the KROSS’s global MIDI channel is received. (Global MIDI channel; see page 159)

However, if the channel of the incoming message is different than the KROSS’s global MIDI channel, the program bank and number will change only for timbres that match the MIDI channel of the message.

Tip: Even for the global MIDI channel, you can change the setting from the default so that the timbre program rather than the combination will be switched. (see page 162 G-MIDI. FILTER “Combination Change”)

Tip: Switching the timbre program in response to MIDI reception can be disabled for specific timbres. (see page 82 C-MIDI FILTER “Enable Program Change”)

When you switch combinations by using the KROSS, the bank and number of the combination you select are transmitted as bank select and program change messages on the global MIDI channel.

At this time, if any of the timbres have the timbre status EXT or EX2, the bank and number of their timbre programs will be transmitted as bank select and program change messages on the timbre channel. (Timbre Status; see page 71 “Status”)

Timbre Info.

Shows the settings of timbres 1-16 for the parameter that you’re editing.

Soloed timbres are indicated by (S).

Note: If this is disabled because of the setting of another parameter, “-” is shown.

0-3: MIXER



Timbre 01...16 (Timbre Number)

To select a timbre (active timbre), place the cursor at one of the following parameters, and use the cursor buttons ◀ ▶ to switch timbres.

Sound [Play, Mute]

This determines whether or not the Timbre will sound.

Play: The timbre will sound.

Mute: The timbre will not sound.

Pan [RND, L001...C064...R127]

This specifies the pan settings of each timbre.

L001...C064...R127: A setting of L001 is far left and R127 is far right. A setting of C064 will reproduce the pan setting of the Program mode.

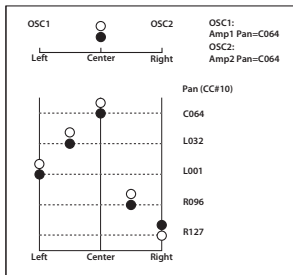
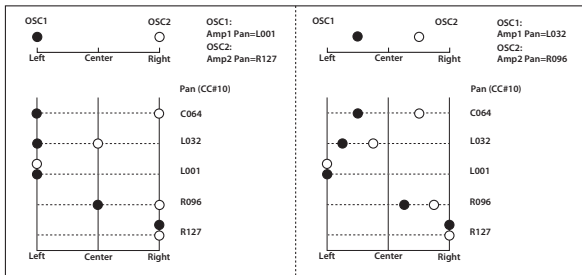

If a mono insert effect is in use, the settings you make here will be ignored. In this case, the **Pan: #8** parameter in C-FX ROUTING> MIXER page will adjust the panning of the sound after the insert effect ("Mixer" on page 202).

Random: The oscillator pan will change randomly at each note-on.

MIDI If **Status** (COMBI> PROG) is set to INT, CC#10 (pan) messages can be received to control the setting. CC#10 values of 0 or 1 will place the sound at far left, 64 at center, and 127 at far right. (exclude RND) Pan can be controlled by messages received on the **MIDI Channel** (C-TIMBRE> MIDI).

Volume [000...127]

Adjusts the volume of each timbre 1-8.

MIDI The volume of each timbre is determined by multiplying this volume value with the MIDI volume (CC#7) and expression (CC#11).

If **Status** (COMBI> PROG) has been set to INT, incoming MIDI CC#7 or CC#11 messages will control the volume of a timbre. (However these messages will not affect the setting of this parameter.)

If **Status** is EXT or EX2, the value of this parameter will be transmitted as MIDI CC#7 when the combination is changed. However this will not be transmitted by a timbre that is set to the same MIDI channel as the global MIDI channel. This message is transmitted on the **MIDI Channel** (C-TIMBRE MIDI) specified for each timbre.

Timbre Info.

Shows the settings of timbres 1-16 for the parameter that you're editing.

Soloed timbres are indicated by (S).

0-4: ARP (Arpeggiator)

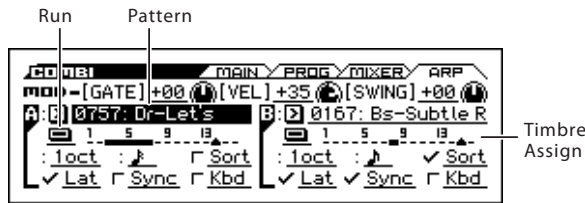

This is the easy edit page for the combination's arpeggiator. A combination lets you use two arpeggiators simultaneously. For detailed editing, use the P-ARP page.

You can also control the arpeggiator in real time by using the TEMPO knob or [GATE], [VELOCITY], and [SWING].

MOD (Modulation)

[GATE] [-64...+00...+63]

Specifies the length (gate time) of each note in the arpeggio (see page 51).

[VEL] (Velocity) [-64...+00...+63]

Specifies the velocity of the notes in the arpeggio (see page 51).

[SWING] [-64...+00...+63]

This parameter shifts the timing of the odd-numbered notes of the arpeggio (see page 52).

A, B (Arpeggiator A, B)

Arpeggiator Run A, B [Off, On]

When the ARP button is on, the arpeggiator(s) you checked here will run if they are assigned to a timbre by **Arpeggiator Assign** (C-ARP> ASSIGN).

When the arpeggiator is on, these check boxes let you turn A and B on/off.

This parameter can also be set from C-ARP> A, B page **Arpeggiator Run A, B**.

Pattern [Preset: UP...RANDOM,0000...1027]

Timbre assign

This shows how arpeggiators A and B are assigned to timbres 1-16. Adjust these settings using **Arpeggiator Assign** (C-ARP> Assign).

Octave [1oct, 2oct, 3oct, 4oct]

Resolution [♪, ♪, ♫, ♫, ♫, ♫, ♫, ♫]

Sort [Off, On]

Lat (Latch) [Off, On]

Sync (Key Sync.) [Off, On]

kbd (Keyboard) [Off, On]

Set the various parameters of the combination arpeggiator. For more information, please see the "6: C-ARP (Arpeggiator)" section on page 84.

These parameters can also be set from C-ARP pages.

✓ 0-1...4: FUNCTION

- 0: **Write Combination, Write/Initialize Combination** see page 94
- 1: **Solo Setting** see page 63
- 2: **Compare** see page 64
- 3: **Auto Song Setup** see page 64
- 4: **Add to Favorite** see page 94
- 5: **Copy from Program** see page 95
- 6: **Hold Balance** see page 95 (only MIXER page)
- 6: **Copy Arpeggiator** see page 95 (only ARP page)

For more information, please see the "Combination: FUNCTION" section on page 94.

1: C-INPUT/CTRL (INPUT/Controllers)

1-1: AUDIO IN

About the AUDIO IN button

Settings in this page are active when the front panel AUDIO IN button is on, allowing an external audio signal to be input.



Input Level Meter

G-SET (Use Global Setting)	[Off, On]
Select	[Line, Mic]
Pan	[L000...L063, C064, R065...R127]
Input Level Meter	
Level	[000...127]
Mute/Play	[Mute, Play]
Gain	[00...82, MAX]
Bus (Bus Select)	[L/R, IFX1...5, Off]
Send1	[000...127]
Send2	[000...127]
FX Control Bus	[Off, FC1, FC2]

These settings are the same as in Program or Global mode.

See "1-1: AUDIO IN" on page 5

1-2: CONTROLLERS (Controllers Setup)

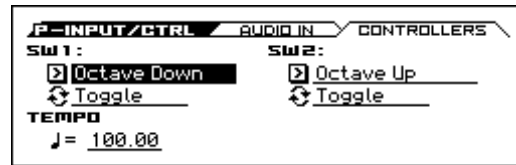

Here you can specify the functions of the front panel SW1 and SW2 buttons, and set the tempo.

Note: The Panel Switch Assign setting of the program assigned to each timbre will have no effect.

SW1

Assign [Off, ..., Pitch Bend Lock]

Mode [Toggle, Momentary]

SW2

Assign [Off, ..., Pitch Bend Lock]

Mode (SW2 Mode) [Toggle, Momentary]

These settings are the same as for a program.

See "1-2: CONTROLLERS (Controllers Setup)" on page 6

TEMPO

♪(Tempo) [40.00... 300.00, EXT]

See "♪(Tempo)" on page 70

✓ 1-1, 2: FUNCTION

- 0: **Write Combination, Write/Initialize Combination** see page 94
- 1: **Solo Setting** see page 63
- 2: **Compare** see page 64
- 3: **Auto Song Setup** see page 64
- 4: **Add to Favorite** see page 94
- 5: **Copy from Program** see page 95

For more information, please see the "Combination: FUNCTION" section on page 94.

2: C-TONE ADJ (Tone Adjust)

The Tone Adjust function lets you make simple changes to the sound by adjusting the main program parameters for each timbre, such as the filter or the filter and amp EG, giving you an easy way to adjust the sound.

The results of editing the Tone Adjust parameters for each timbre are saved in the combination.

This lets you adjust the sound of each timbre without modifying the original program sounds. For example, it's easy to brighten the sound of a timbre by raising its cutoff frequency so that it will fit better with the other sounds of the combination.

Tone Adjust settings and MIDI control changes

Many of the program parameters that are affected by Tone Adjust can also be modified via MIDI CC.

Adjustments via Tone Adjust and changes via MIDI CC are always enabled; these two are combined to determine the actual change that is applied.

The MIDI control change numbers (CC#) corresponding to each Tone Adjust parameter are shown below.

Cutoff: CC#74

Resonance: CC#71

EG Intensity: CC#79

Vel. Intensity: Not supported

Attack: CC#75

Decay: CC#75

Sustain: CC#70

Release: CC#72

See page 297, 303

2-1: TONE ADJUST

The Tone Adjust function lets you make simple changes to the sound by adjusting the timbre program's main parameters, such as the filter or the filter and amp EG.

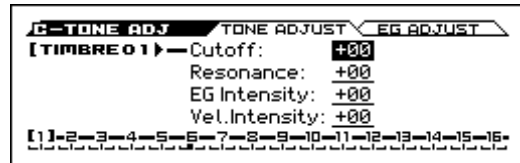

Most of these functions adjust (scale) the parameter settings of the timbre programs. Unless otherwise noted, "scaling" means that the parameters are at their programmed values when the controller is at 64, at their minimum when the controller is at -99, and at their maximum when the controller is at +99. For another look at this, please see the diagram below.

CC parameter scaling

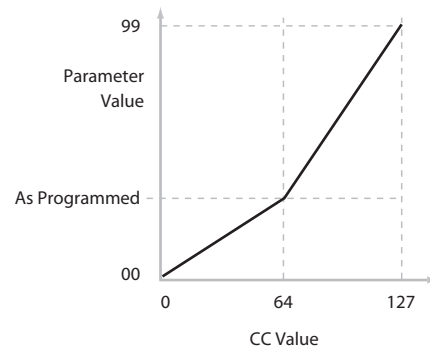

Timbre 01...16 (Timbre Number)

To select a timbre (active timbre), place the cursor at one of the following parameters, and use the cursor buttons ◀ ▶ to switch timbres. (see page 71)

Cutoff (Filter Cutoff) [-99...+99]

Adjusts the cutoff frequency of filters A and B.

Resonance (Filter Resonance) [-99...+99]

Adjusts the resonance of filters A and B.

EG Intensity (Filter EG Intensity) [-99...+99]

Adjusts the effect of the filter EG on the cutoff frequency of filters A and B.

Vel. Intensity (Amp Velocity Intensity) [-99...+99]

Adjusts the velocity intensity for the amp level.

Timbre Info.

Shows the settings of timbres 1-16 for the parameter that you're editing.

Soloed timbres are indicated by (S).

2-2: EG ADJUST



Timbre 01...16 (Timbre Number)

To select a timbre (active timbre), place the cursor at one of the following parameters, and use the cursor buttons ◀ ▶ to switch timbres. (see page 71)

Attack (Filter/Amp EG Attack Time) [-99...+99]

This scales the attack times of the Filter and Amp EGs, along with other related parameters.

When the value is +1 or more, this also affects the Amp EG's Start and Attack Levels, Start Level AMS, and Attack Time AMS.

Between values of +1 and +25, the Start Level, Start Level AMS, and Attack Time AMS will change from their programmed values to 0. Over the same range, the Attack Level will change from its programmed value to 99.

Decay (Filter/Amp EG Decay Time) [-99...+99]

This scales the decay and slope times of the Filter and Amp EGs.

Sustain (Filter/Amp EG Sustain Level) [-99...+99]

This scales the sustain levels of the Filter and Amp EGs.

Release (Filter/Amp EG Release Time) [-99...+99]

This scales the release times of the Filter and Amp EGs.

Timbre Info.

Shows the settings of timbres 1-16 for the parameter that you're editing.

Soloed timbres are indicated by (S).

∨ 2-1, 2: FUNCTION

- 0: **Write Combination, Write/Initialize Combination** see page 94
- 1: **Solo Setting** see page 63
- 2: **Compare** see page 64
- 3: **Auto Song Setup** see page 64
- 4: **Add to Favorite** see page 94
- 5: **Copy from Program** see page 95

For more information, please see the "Combination: FUNCTION" section on page 94.

3: C-TIMBRE (Timbre Parameters)

3-1: MIDI

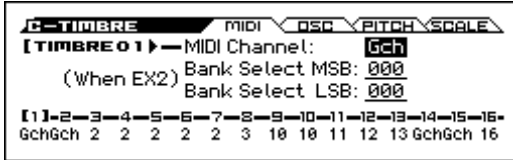

Here you can adjust MIDI settings for timbres 1–16.

Timbre 01...16 (Timbre Number)

To select a timbre (active timbre), place the cursor at one of the following parameters, and use the cursor buttons ◀▶ to switch timbres. (see page 71)

MIDI Channel [01...16, Gch]

Sets the MIDI transmit/receive channel for each timbre.

Gch: The timbre will use the channel that has been selected as the global **MIDI Channel** (G-MIDI> BASIC).

When **Status** is INT, MIDI messages will be received on the channel you specify here. If this setting is the same as the global MIDI channel, the internal tone generator will sound according to the internal settings. If this is set to EXT or EX2, playing the KROSS will transmit MIDI messages on the MIDI channel specified here. (Messages will also be transmitted simultaneously on the global MIDI channel.)

Bank Select (When Status = EX2) MSB [000...127]

Bank Select (When Status = EX2) LSB [000...127]

Specifies the bank number that will be transmitted when **Status** is set to EX2. The upper line is the MSB, and the lower line is the LSB. This setting has no effect if **Status** is other than EX2.

Timbre Info.

Shows the settings of timbres 1–16 for the parameter that you're editing.

Soloed timbres are indicated by (S).

3-2: OSC



These settings specify how timbres 1–16 will be played.

Timbre 01...16 (Timbre Number)

To select a timbre (active timbre), place the cursor at one of the following parameters, and use the cursor buttons ◀▶ to switch timbres. (see page 71)

Force OSC Mode [PRG, Poly, Mono, Legato]

This lets you override the Program's stored Voice Assign Mode settings, if desired.

PRG: The mode will be according to the Voice (Voice Assign Mode) setting in the program's P-BASIC> VOICE page.

Poly: The timbre will play polyphonically, regardless of the Program's settings.

Mono: The timbre will play monophonically, regardless of the Program's settings.

Legato: The timbre will sound monophonically, and will play legato according to the Program's **VOICE** setting.

With the Mono or Legato settings, the Program's **Priority** setting (P-BASIC> VOICE) will determine the priority of the note that sounds when you play two or more notes.

OSC Select [OSC1&2, only OSC1, only OSC2]

Specifies whether the timbre's program will play OSC1, OSC2, or both.

For programs whose **Oscillator Mode** (P-BASIC> VOICE) is Double, this setting lets you specify that only OSC1 or OSC2 will sound.

OSC1&2: OSC1 and 2 will sound as specified by the settings of the program.

only OSC1: Only OSC1 will sound.

only OSC2: Only OSC2 will sound. Programs will not sound if **Oscillator Mode** is set to Single or Drums.

Portamento [PRG, Off, 001...127]

Create portamento settings for each timbre.

PRG: Portamento will be applied as specified by the program settings.

Off: Portamento will be off, even if the original program settings specified Portamento to be on.

001...127: Portamento will be applied with the portamento time you specify here even if it is turned off by the program settings.

MIDI If the **Status** (COMBI> PROG) is set to INT, CC#05 (portamento time) and CC#65 (portamento switch) messages will be received and will control and change these settings. (If the setting is PRG, CC#05, portamento time will not be received.) These messages will be received on the MIDI channel specified for each timbre by **MIDI Channel** (C-TIMBRE> MIDI).

Timbre Info.

Shows the settings of timbres 1–16 for the parameter that you're editing.

Soloed timbres are indicated by (S).

3-3: PITCH

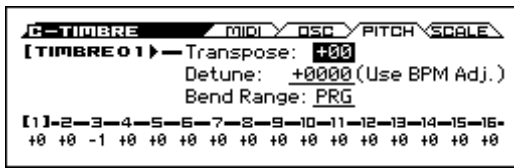

Here you can adjust pitch-related settings for timbres 1-16.

Timbre 01...16 (Timbre Number)

To select a timbre (active timbre), place the cursor at one of the following parameters, and use the cursor buttons ◀▶ to switch timbres.(see page 71)

Transpose [-60...+00...+60]

Adjusts the pitch of each timbre in semitone steps. 12 units equal one octave.

MIDI When **Status** (COMBI> PROG) is INT, this parameter will affect the pitches sounded by the KROSS. When **Status** is EXT, this parameter will affect the note numbers of the MIDI note messages that are transmitted.

For example if you adjust settings of +04 and +07 respectively for two timbres that are set to EXT, playing the C key will transmit a C note number on the global MIDI channel, and at the same time will also transmit E and G note numbers on the MIDI channels of those timbres.

Detune (Use BPM Adj.) [-1200...+0000...+1200]

Adjusts the pitch of each timbre in one-cent units.

+0000: Normal pitch.

Note: You can also use the **Detune BPM Adjust** function to alter a loop's tempo via detuning. Since this will alter the pitch of the loop along with the tempo, it's generally suited only to un-pitched percussive loops.

MIDI **Transpose** and **Detune** can be controlled via MIDI RPN messages. The way that this works depends on whether or not the Timbre uses a Drum Program.

If the Timbre does not use a Drum Program for example, if it uses a Single or Double Program then MIDI RPN Coarse Tune will control **Transpose**, and RPN Fine Tune will control **Detune**.

If the Timbre uses a Drum Program, MIDI RPN Coarse Tune and Fine Tune will be combined to control **Detune**. The overall range is ±1 octave for coarse tune and fine tune together.

Bend Range [PRG, -24...+00...+24]

Specifies the maximum amount of pitch change (in semitones) that will occur when the pitch bend wheel is used.

PRG: The pitch range specified by the program will be used.

-24...+24: This setting will be used regardless of the setting in the program.

MIDI The MIDI RPN Pitch Bend Change message can be received to control this and change the setting. (However it will not be received if this parameter is set to PRG.) This message is received on the MIDI channel for each timbre set by **MIDI Channel** (C-TIMBRE> MIDI).

Timbre Info.

Shows the settings of timbres 1-16 for the parameter that you're editing.

Soloed timbres are indicated by (S).

3-4: SCALE

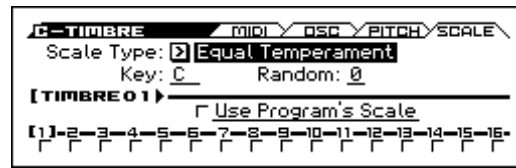

Here you can adjust settings for the scale of timbres 1-16.

Scale Type [Equal Temperament...User Octave Scale15]

Selects the scale.

For more information, please see the "2-3: SCALE" section on page 10.

Key [C...B]

Selects the tonic key of the selected scale.

Random [0...7]

As this value is increased, an increasingly random deviation will be added to the pitch at each note-on.

MIDI If **Status** (COBI> PROG) is INT, this setting will affect the pitch produced by the KROSS. If **Status** is EXT, this setting will affect the note number of the note messages transmitted via MIDI.

Timbre 01...16 (Timbre Number)

To select a timbre (active timbre), place the cursor at one of the following parameters, and use the cursor buttons ◀▶ to switch timbres.(see page 71)

Use Program's Scale [Off, On]

Timbre can use the scale that is specified by **Scale** (P-BASIC> SCALE).

On (checked): The scale specified by the program will be used.

Off (unchecked): The scale specified by **Scale Type** will be used.

Timbre Info.

Shows the settings of timbres 1-16 for the parameter that you're editing.

Soloed timbres are indicated by (S).

✓ 3-1...4: FUNCTION

- 0: **Write Combination, Write/Initialize Combination** see page 94
- 1: **Solo Setting** see page 63
- 2: **Compare** see page 64
- 3: **Auto Song Setup** see page 64
- 4: **Add to Favorite** see page 94
- 5: **Copy from Program** see page 95
- 6: **Detune BPM Adjust** see page 95 (only OSC page)

For more information, please see the "Combination: FUNCTION" section on page 94.

4: C-ZONE/DELAY

4-1: KEY ZONE (Keyboard Zone)

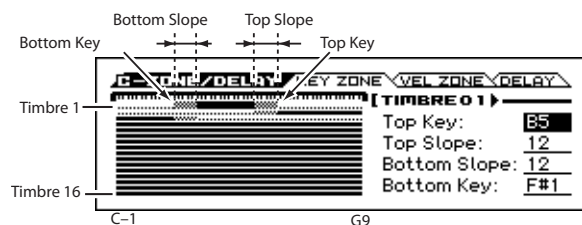

These settings specify the keyboard range where timbres 1–16 will sound.

The top/bottom key parameters specify the range of notes where timbres 1–16 will sound, and the top/bottom slope parameters specify the range where the original volume will be reached.

Key Split: By setting timbres of different sounds to ranges that do not overlap, you can play different sounds in different ranges of the keyboard.

Layer: By setting the ranges to overlap, you can play two or more sounds with a single note.

Positional Cross-fade: If you set the slopes (the grayed portion) to overlap, the sounds will overlap, and the proportion of the overlap will change according to the keyboard location.

Zone Map

This indicates the range of notes where each timbre will sound.

A line indicates the range of notes that will sound, and the slope within that range is shaded.

Timbre 01...16 (Timbre Number)

To select a timbre (active timbre), place the cursor at one of the following parameters, and use the cursor buttons ◀▶ to switch timbres. (see page 71)

Top Key [C-1...G9]

Specifies the top key (upper limit) of the notes that will sound each timbre.

Top Slope [00, 01, 02, 03, 04, 06, 08, 10, 12, 18, 24, 30, 36, 48, 60, 72]

Specifies the range of keys (12 is one octave) where the volume will be reached starting from the top key.

0: The volume will be at the original level from the top key.

12: The volume will increase gradually as you play downward, and will reach the original volume one octave below the top key.

72: The volume will increase gradually as you play downward, and will reach the original volume six octaves below the top key.

Bottom Slope [00, 01, 02, 03, 04, 06, 08, 10, 12, 18, 24, 30, 36, 48, 60, 72]

Specifies the range of keys (12 is one octave) where the volume will be reached starting from the bottom key.

0: The volume will be at the original level from the bottom key.

12: The volume will increase gradually as you play upward, and will reach the original volume one octave above the bottom key.

72: The volume will increase gradually as you play upward, and will reach the original volume six octaves above the bottom key.

Bottom Key [C-1...G9]

Specifies the bottom key (lower limit) of the notes that will sound each timbre.

How volume will change according to keyboard location

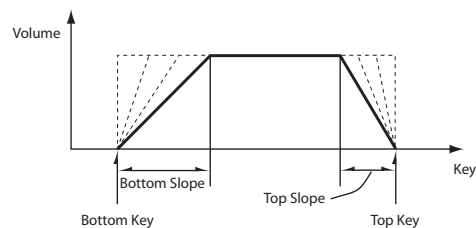

Tips: Note values and velocity values can also be entered using the keyboard. (see page 12 of the Operation Guide)

⚠ It is not possible to set the bottom key above the top key of the same timbre. Nor is it possible for the top and bottom slopes to overlap.

4-2: VEL ZONE (Velocity Zone)

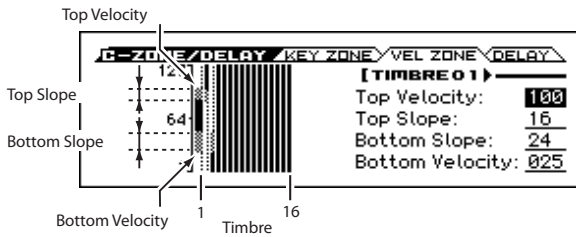

Sets the Top/Bottom Velocity parameters to specify the range of velocities that will sound for each timbre 1–8 and 9–16, and set the Top/Bottom Slope parameters to specify the range where the volume will change.

Velocity switch: If you set different velocity zones for multiple timbres so that they do not sound together, you can play separate sounds by varying playing dynamics.

Layer: If you set two or more timbres to velocity zones that overlap, the sounds will be heard together.

Velocity Cross-fade: If the slope ranges (gray line) overlap, different sounds will be sounded together, and your playing dynamics will determine the proportion of each sound.

 It is not possible to set the bottom velocity greater than the top velocity for the same timbre, nor can the top slope and the bottom slope overlap.

Zone Map

This area indicates velocity ranges where each timbre will sound. A line indicates the range of notes that will sound, and the slope within that range is shaded.

Timbre 01...16 (Timbre Number)

To select a timbre (active timbre), place the cursor at one of the following parameters, and use the cursor buttons ◀ ▶ to switch timbres.(see page 71)

Top Velocity [001...127]

Specifies the maximum velocity value that will sound each timbre.

Top Slope [000...120]

Specifies the number of velocity steps where the original volume will be reached, starting from the Top Velocity.

0: The volume will be at the original value from the top velocity.

120: The volume will decrease as the velocity approaches the top velocity.

Bottom Slope [000...120]

Specifies the number of velocity steps where the original volume will be reached, starting from the Bottom Velocity.

0: The volume will be at the original value from the bottom velocity.

120: The volume will decrease as the velocity approaches the bottom velocity.

Bottom Velocity [001...127]

Specifies the minimum velocity value that will sound each timbre.

How volume will change according to keyboard location

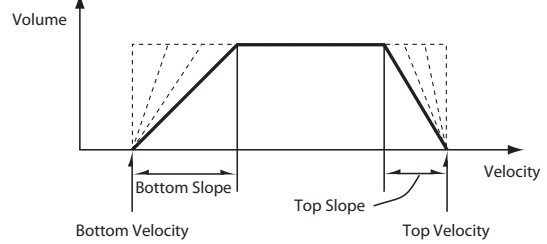

Note: You can also set the note values and velocity values by the keyboard (see page 12 of the Operation Guide).

4-3: DELAY

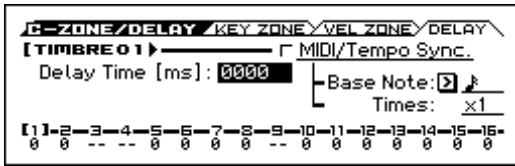

This specifies the time (delay) from when the timbres 1–16 receive a note-on until the sound begins.

Timbre 01...16 (Timbre Number)

To select a timbre (active timbre), place the cursor at one of the following parameters, and use the cursor buttons ◀▶ to switch timbres. (see page 71)

Delay Time [ms] [0000...5000ms, KeyOff]

Specifies the time (delay time) from note-on until the timbre begins to produce sound, in units of ms (1/1000th of a second). This setting is available if **MIDI/Tempo Sync.** is set to Off.

KeyOff: The note will begin sounding at note-off. In this case, the sound will not die away if the sustain level of the program's amp EG is other than 0. This setting is used when creating harpsichord sounds.

Normally you will set this to 0000.

MIDI/Tempo Sync. [Off, On]

The time (delay time) from note-on until the timbre produces sound will be specified in note length units relative to the ♩ (**Tempo**).

On (checked): Specify the delay time in terms of a **Base Note** and **Times** relative to the **Tempo**. For example if **Base Note** = ♩, **Times** = 01, and **Tempo** = 60 BPM, the delay time will be equivalent to 1000 ms.

Off (unchecked): The delay time will be set by the **Delay Time** setting.

Base Note [♩, ♪, ♫, ♮, ♯, ♭, ♮, ♯, ♭, ♮, ♯, ♭, ♮, ♯, ♭, ♮]

Times [x1...x32]

It specifies the time (delay time) from note-on until the timbre begins to produce sound, in terms of a note value relative to the ♩ (**Tempo**) (COMBI> MAIN).

Use **Base Note** to specify the desired note value, and use **Times** to extend that note value by the specified multiple.

For example if you set **Base Note** to a quarter note (♩) and **Times** to 02, that timbre will sound with a delay of a half note (♪). Even if you change ♩ (**Tempo**), the delay time will always be a half note (♪). If you use these parameters to specify a delay of a half note (♪). In this case, a **Tempo** of 60.00 BPM will produce a 2000 ms delay, and a **Tempo** of 120.00 BPM will produce a 1000 ms delay.

Timbre Info.

Shows the settings of timbres 1–16 for the parameter that you're editing.

Soloed timbres are indicated by (S).

✓ 4-1...3: FUNCTION

- 0: **Write Combination, Write/Initialize Combination** see page 94
- 1: **Solo Setting** see page 63
- 2: **Compare** see page 64
- 3: **Auto Song Setup** see page 64
- 4: **Add to Favorite** see page 94
- 5: **Copy from Program** see page 95

For more information, please see the "Combination: FUNCTION" section on page 94.

5: C-MIDI FILTER

These settings allow you to apply filters to the MIDI data that will be transmitted and received by each timbre 1–16. For example even if two timbres are being played by the same MIDI channel, you can adjust settings so that the damper pedal will apply to one but not the other.

On (checked): Transmission and reception or reception (After Touch) of MIDI data is enabled.

If **Status** (COMBI> PROG) is INT, the effects of the checked items will be applied to the timbre's program when the controllers of the KROSS are used or when MIDI data is received. (Effect Dynamic Modulation is not affected by these settings.)

In the case of EXT or EX2, operating a controller on the KROSS will transmit MIDI data on the channel of that timbre. MIDI transmission/reception settings for the entire KROSS can be made in **MIDI Filter** (G-MIDI> FILTER).

The MIDI Filter 3 contains MIDI filters for assignable controllers (whose function can be set by the user), and if these are assigned to MIDI control changes, the filter settings will affect those control changes. In this case, if the same control change has been assigned in MIDI Filter pages 1–2, the settings in MIDI Filter pages 1–2 will take priority. Also, if the same control change is assigned to two or more controllers in the MIDI Filter pages 3, checking any one of them will enable that control change.

Off (unchecked): Transmission and reception of MIDI data is disabled.

Note: MIDI CC# = MIDI control change message numbers.

5–1: 1 (MIDI Filter1)

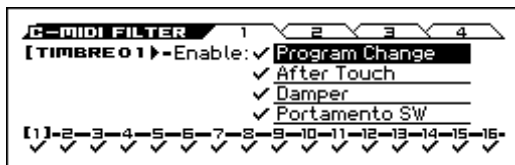

Timbre 01...16 (Timbre Number)

To select a timbre (active timbre), place the cursor at one of the following parameters, and use the cursor buttons ◀▶ to switch timbres.(see page 71)

Enable Program Change [Off, On]

Specifies whether or not MIDI program change messages will be transmitted and received.

Enable After Touch [Off, On]

Specifies whether or not MIDI after touch messages will be received.

Enable Damper [Off, On]

Specifies whether or not MIDI CC#64 hold (damper pedal) messages will be transmitted and received.

Enable Portamento SW [Off, On]

Specifies whether or not MIDI CC#65 portamento on/off messages will be transmitted and received.

Timbre Info.

Shows the settings of timbres 1–16 for the parameter that you're editing.

Soloed timbres are indicated by (S).

5–2: 2 (MIDI Filter2)



Timbre 01...16 (Timbre Number)

To select a timbre (active timbre), place the cursor at one of the following parameters, and use the cursor buttons ◀▶ to switch timbres.(see page 71)

Enable Pitch Bend as AMS [Off, On]

Specifies whether or not MIDI pitch bend messages (the pitch bend wheel settings) will be received to control the AMS effect assigned to Pitch Bend. (This is not a filter for MIDI pitch bend message reception.) For more information, please see “Alternate Modulation Sources (AMS)” on page 281.

Enable Mod.Wheel:CC#01 [Off, On]

Specifies whether MIDI CC#1 (the pitch bend wheel setting) will be transmitted and received.

Enable JS-Y CC#02 [Off, On]

Specifies whether MIDI CC#2 will be transmitted and received.

Enable Ribbon CC#16 [Off, On]

Specifies whether or not MIDI CC#16 will be transmitted or received.

Timbre Info.

Shows the settings of timbres 1–16 for the parameter that you're editing.

Soloed timbres are indicated by (S).

5-3: 3 (MIDI Filter3)

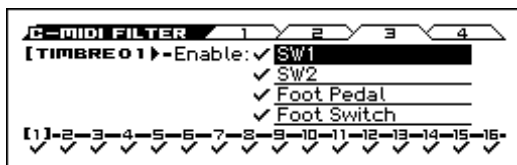

Timbre 01...16 (Timbre Number)

To select a timbre (active timbre), place the cursor at one of the following parameters, and use the cursor buttons ◀▶ to switch timbres. (see page 71)

Enable SW1 [Off, On]

Enable SW2 [Off, On]

These settings specify whether SW1 Mod (CC#80) and SW2 Mod (CC#81) will be transmitted and received if they are assigned to the SW1 and SW2 buttons.

Note: If Portamento SW (CC#65) is assigned to SW1 or SW2, the Enable Portamento SW setting on the 1 (MIDI Filter1) page will take priority.

Note: The functions of SW1 and SW2 are assigned on the C-INPUT/CTRL> CONTROLLERS page (see page 74).

Enable Foot Pedal [Off, On]

If a control change is assigned to the ASSIGNABLE PEDAL, this specifies whether the effect will be transmitted and received. The function is assigned in the GLOBAL G-INPUT/CTRL> FOOT page.

Enable Foot Switch [Off, On]

If a control change is assigned to the ASSIGNABLE SWITCH, this specifies whether the effect will be transmitted and received. The function is assigned in the GLOBAL G-INPUT/CTRL> FOOT page.

Timbre Info.

Shows the settings of timbres 1–16 for the parameter that you're editing.

Soloed timbres are indicated by (S).

5-4: 4 (MIDI Filter4)

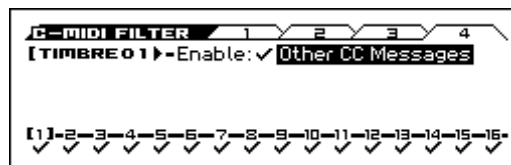

Timbre 01...16 (Timbre Number)

To select a timbre (active timbre), place the cursor at one of the following parameters, and use the cursor buttons ◀▶ to switch timbres. (see page 71)

Enable Other CC Messages [Off, On]

Specifies whether or not MIDI control messages not covered in the preceding items MIDI Filter will be transmitted and received.

Timbre Info.

Shows the settings of timbres 1–16 for the parameter that you're editing.

Soloed timbres are indicated by (S).

Note: If this is disabled because of the setting of another parameter, “–” is shown.

✓ 5-1...4: FUNCTION

- 0: **Write Combination, Write/Initialize Combination** see page 94
- 1: **Solo Setting** see page 63
- 2: **Compare** see page 64
- 3: **Auto Song Setup** see page 64
- 4: **Add to Favorite** see page 94
- 5: **Copy from Program** see page 95

For more information, please see the “Combination: FUNCTION” section on page 94.

6: C-ARP (Arpeggiator)

These parameters specify how the arpeggiator will function within the combination. Two arpeggiators can run simultaneously.

This offers a variety of possibilities, such as applying separate arpeggio patterns to two sounds that have been assigned as a keyboard split, or using velocity to switch between two arpeggio patterns.

6-1: ASSIGN



Timbre 01...16 (Timbre Number)

To select a timbre (active timbre), place the cursor at one of the following parameters, and use the cursor buttons ◀ ▶ to switch timbres. (see page 71)

ARP Assign [Off, A, B]

Assigns arpeggiator A or B to each timbre 1-16. When the ARP button is on, the arpeggiator specified for each timbre will operate according to **Arpeggiator Run A, B** and these settings.

Off: The arpeggiator will be off.

A: Arpeggiator A will be on. Use the settings in the Arpeggiator A page to select the arpeggio pattern and to set parameters.

B: Arpeggiator B will be on. Use the settings in the Arpeggiator B page to select the arpeggio pattern and to set parameters.

MIDI If the **Status** (COMBI> PROG) of the timbre is **INT**, each timbre 1-16 will be sounded by the note data generated by the assigned arpeggiator, regardless of the **MIDI Channel** (C-TIMBRE> MIDI) setting of the timbre. If a timbre is set to **EXT** or **EX2**, MIDI note data will be transmitted on the **MIDI Channel** of that timbre.

In this case, arpeggiator A (or B) will be triggered (used) by all MIDI channels specified for the **MIDI Channel** parameter of any timbre 1-16 assigned to arpeggiator A or B.

Local Control (Local Control On, G-MIDI> BASIC) is OFF, the keyboard will not trigger the arpeggiator. The arpeggiator will be triggered via MIDI IN. Turn Local Control OFF if you have recorded only the trigger notes on an external sequencer, and wish to playback the external sequencer to trigger the KROSS's arpeggiator.

MIDI If you want to record the note data generated by the arpeggiator to an external sequencer, turn Local Control ON, and turn off the echo back function on your external sequencer.

You can control the arpeggiator from an external sequencer, or use an external sequencer to record arpeggio note data. (See page 306)

Example 1)

Set the MIDI Channel (C-TIMBRE> MIDI) of timbres 1 and 2 to **Gch**, and set **Status** (COMBI> PROG) to **INT**. Assign arpeggiator A to timbre 1 and arpeggiator B to timbre 2, and check **Arpeggiator Run A, B** (COMBI> ARP).

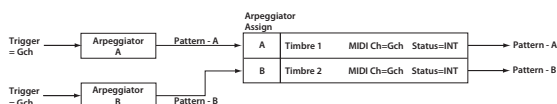

- When the ARP button is off, timbres 1 and 2 will sound simultaneously (layered) when you play the keyboard.
- When the ARP button is turned on, timbre 1 will be played by arpeggiator A, and timbre 2 will be played by arpeggiator B.

Example 2)

The **MIDI Channel** (C-TIMBRE> MIDI) of timbres 1, 2, 3, 4, and 5 are set respectively to **Gch**, **Gch**, **02**, **Gch**, and **03**. Their **Status** (COMBI> PROG) is set respectively to **INT**, **Off**, **INT**, **Off**, and **INT**. Assign arpeggiator A to timbres 2 and 3, assign arpeggiator B to timbres 4 and 5, and check **Arpeggiator Run A, B** (COMBI> ARP).

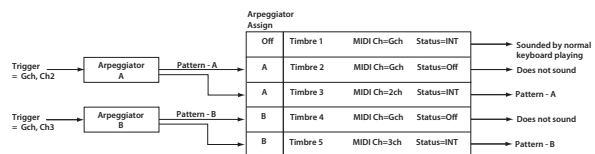

- When the ARP button is off, playing the keyboard will only sound timbre 1. (Timbres 2 and 4 are receiving the **Gch**, but they will not sound since their **Status** is **Off**.)
- When you turn on the ARP button, arpeggiator A will play timbres 2 and 3, and arpeggiator B will independently play timbres 4 and 5. (Arpeggiators A and B are triggered by note data received from any MIDI channel of an assigned timbre. However, in this example, they are being triggered from the **Gch**.)

When you play the keyboard, arpeggiator A will play timbres 2 and 3, but only timbre 3, whose **Status** is **INT** will sound from the keyboard. Similarly, arpeggiator B will play timbres 4 and 5, but only timbre 5, whose **Status** is **INT** will sound from the keyboard.

In this way, you can adjust the settings so that a timbre is silent when the arpeggiator is off, and sounds only when the arpeggiator is on.

This type of setting is used in preloaded combinations which sound the drums only when the arpeggiator is on. (see page 71 of the Operation Guide)

Timbre Info.

Shows the settings of timbres 1-16 for the parameter that you're editing.

Soloed timbres are indicated by (S).

7: C-DRUM TRACK

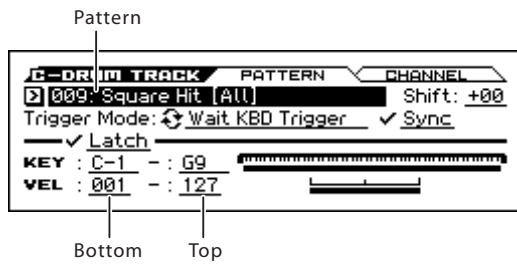

Here you can adjust settings for the Drum Track used by the combination.

Here you can select a pattern for the Drum Track, specify how it will start playing (Trigger), and specify the channel that it will play.

Unlike Program mode, Combination mode does not have a timbre dedicated to the Drum Track; you must assign one of the timbres 1-16 to the Drum Track. To play the Drum Track pattern, you'll need to assign a drum program to a timbre and set the Drum Track's output MIDI channel to match that timbre's MIDI channel.

In Combination mode, the Drum Track's synchronized start function (Trigger) will synchronize only to playing on the global MIDI channel, regardless of this channel setting.

MIDI transmission and reception for the drum track

In Combination mode, the Drum Track function transmits and receives on the following MIDI channels.

Receive: If you're controlling the triggering by playing the keyboard, the drum track will receive on the global MIDI channel.

Transmit: The drum track will transmit on the MIDI channel specified by the Drum Pattern **Output** setting (C-DRUM TRAK> CHANNEL) of each combination.

Set this to match the MIDI channel of the timbre you've specified for the drum program.

If the timbre's **Status** is EXT or EX2, the note data etc. of the Drum Track pattern will be transmitted.

If local control ("Local Control On: G-MIDI) is on, playing the KROSS's keyboard will not make the internal sound generator produce sound, nor can the keyboard trigger the arpeggiator or drum track. However, they can be triggered by note-on messages from MIDI IN.

Wait KBD Trigger: When you press the DRUM TRACK button to turn it on (LED lit), the drum pattern will wait to start. When you play the keyboard, or when a MIDI note-on is received, the drum pattern will start according to the **Sync** setting.

⚠ If you've selected **Start Immediately**, the DRUM TRACK button will always be saved in the OFF state.

Sync [Off, On]

Off: The drum pattern will not synchronize to the currently-running arpeggiator or step sequencer, but will start immediately.

On: The drum pattern will synchronize to the currently-running arpeggiator or step sequencer.

Note: Use C-ARP> A (or B) **Key Sync** to specify whether the arpeggiator will synchronize to the currently-running drum pattern.

Latch [Off, On]

This specifies whether the drum track will continue playing even after you take your hand off the keyboard.

This is valid if **Trigger Mode** is **Wait KBD Trigger**.

Off: If the DRUM TRACK button is on (LED blinking), the pattern will start when you play the keyboard (note-on). The pattern will stop when you release the keyboard (note-off).

On: If the DRUM TRACK button is on (LED blinking), the pattern will start when you play the keyboard (note-on). The pattern will continue when you release the keyboard (note-off). The pattern will stop when you turn the DRUM TRACK button off (LED dark).

Zone

KEY

Bottom [C-1...G9]

Top [C-1...G9]

This is valid if **Trigger Mode** is set to **Wait KBD Trigger**.

It specifies the range of keys that will start the drum pattern.

Velocity

Bottom [001...127]

Top [001...127]

This is valid if **Trigger Mode** is set to **Wait KBD Trigger**.

It specifies the range of velocities that will start the drum pattern.

Tip: You can also set the note values and velocity values by the keyboard (see page 12 of the Operation Guide).

7-1: PATTERN

Pattern [000, 001...700]

This selects the drum pattern.

Preset/User No.	Contents
000	Off
001...700	Preset drum patterns

Shift [-24...+00...+24]

This transposes the drum pattern in semitone steps. This means that the instruments of the drum kit will change.

Note: If you've selected a GM drum program for the Drum Track, you should set this to -12.

Trigger Mode [Start Immediately, Wait KBD Trigger]

Start Immediately: When you press the DRUM TRACK button to turn it on (LED lit), the drum pattern will start according to the **Sync** setting. When you turn it off (LED dark), the drum pattern will stop.

7-2: CHANNEL (MIDI Channel)

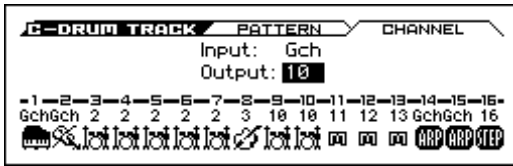

Input [Gch]

If the Trigger Mode is set to Wait KBD Trigger, you can control the trigger by playing the keyboard on this MIDI channel.

In Combination mode, this Input is fixed at Gch.

Output [01...16, Gch]

This specifies the MIDI channel that will transmit the MIDI data of the drum pattern. The drum pattern will trigger the program of the timbre that is set to this same MIDI channel.

Gch: The data will be sent to the channel specified by the global MIDI channel **MIDI Channel** setting (G-MIDI> BASIC).

Whether the pattern data will be output to an external device will depend on the **Status** setting of the timbre that matches the **Output** MIDI channel.

Timbre Info.

This shows the MIDI channels of timbres 1–16. Set “Output” to the MIDI channel of the timbre that you want to play using the Drum Track.

 In this page, you can't use cursor buttons ◀▶ to select timbres.

✓ 7-1, 2: FUNCTION

- 0: **Write Combination, Write/Initialize Combination** see page 94
- 1: **Solo Setting** see page 63
- 2: **Compare** see page 64
- 3: **Auto Song Setup** see page 64
- 4: **Add to Favorite** see page 94
- 5: **Copy from Program** see page 95
- 6: **Copy Drum Track** see page 96

For more information, please see the “Combination: FUNCTION” section on page 94.

8: C-STEP SEQ (Step Sequencer)

Here you can adjust settings for the step sequencer used by the combination.

Note: To use the step sequencer, turn STEP SEQ On/Off “on” (COMBI> PROG page).

MIDI transmission/reception for the step sequencer

Step sequencer functions in Combination mode are transmitted and received using the MIDI channel of timbre 16.

 The on/off state of the RUN button cannot be saved.

8-1: BASIC



Program [000...040]

Here you can select the drum program that will be used by the step sequencer.

This parameter is linked with the program select (COMBI> PROG page) of timbre 16 when STEP SEQ is on.

J (Tempo) [40.00... 300.00, EXT]

Resolution [1/8, 1/4, 1/2, 3/4, 1, 3/2, 2, 3, 4]

Lgth (Length) [01...64]

Step/Bt (Steps per Beat for Swing) [x1, x2, x4]

These settings are the same as for a program.

See “15-1: BASIC” on page 55

8-2: EDIT

Indicates the tone for which you can use the front panel 1-16 buttons to turn steps on/off.

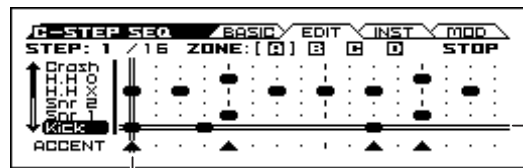

When you turn RUN on, the indication will move to the left, showing the currently-playing step.

STEP SEQ - SETUP button

STEP */# [1...64/01...64]

ZONE [A, B, C, D]

STATUS [STOP, RUN]

TONE 01 (Kick/Note No.) [Step Off, On]

TONE 02 (Snr 1/Note No.) [Step Off, On]

TONE 03 (Snr 2/Note No.) [Step Off, On]

TONE 04 (H.H X/Note No.) [Step Off, On]

TONE 05 (H.H O/Note No.) [Step Off, On]

TONE 06 (Crash/Note No.) [Step Off, On]

TONE 07 (Ride/Note No.) [Step Off, On]

TONE 08 (Tom L/Note No.) [Step Off, On]

TONE 09 (Tom H/Note No.) [Step Off, On]

TONE 10 (Perc 1/Note No.) [Step Off, On]

TONE 11 (Perc 2/Note No.) [Step Off, On]

TONE 12 (SFX/Note No.) [Step Off, On]

ACCENT [Off, On]

These settings are the same as for a program.

See “15-2: EDIT” on page 56

8-3: INST (Instruments)

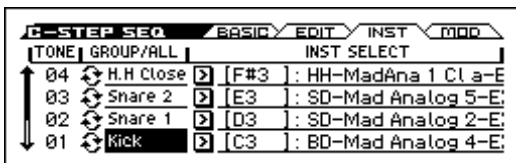

TONE 01 GROUP/ALL	[Kick, ALL]
TONE 02 GROUP/ALL	[Snare 1, ALL]
TONE 03 GROUP/ALL	[Snare 2, ALL]
TONE 04 GROUP/ALL	[H.H Close, ALL]
TONE 05 GROUP/ALL	[H.H Open, ALL]
TONE 06 GROUP/ALL	[Crash, ALL]
TONE 07 GROUP/ALL	[Ride, ALL]
TONE 08 GROUP/ALL	[Tom L, ALL]
TONE 09 GROUP/ALL	[Tom H, ALL]
TONE 10 GROUP/ALL	[Perc 1, ALL]
TONE 11 GROUP/ALL	[Perc 2, ALL]
TONE 12 GROUP/ALL	[SFX, ALL]

These settings are the same as for a program.
See "15-3: INST (Instrument)" on page 57

8-4: MOD (Modulation)



MODULATION CONTROLS

Velocity	[-64...+0...+63]
Swing	[-64...+0...+63]
Accent	[-64...+0...+63]

These settings are the same as for a program.
See "15-4: MOD (Modulation)" on page 57

8-1...4: FUNCTION

- 0: Write Combination, Write/Initialize Combination see page 94
- 1: Solo Setting see page 63
- 2: Compare see page 64
- 3: Auto Song Setup see page 64
- 4: Add to Favorite see page 94
- 5: Copy from Program see page 95
- 6: Assign inst to Tone see page 96
- 7: Edits Step Parameters see page 96
- 8: Copy Step Seq see page 96

For more information, please see the "Combination: FUNCTION" section on page 94.

9: C-FX ROUTING

You can also specify the bus routing for the program used by each of the timbres, 1–16. For instance, you can:

- Send the output of a timbre to an insert effect
- Route a sound to an insert effect
- Create detailed settings for insert effects

For more details on the Insert Effects, please see the “Effect Guide” on page 197.

9-1: BUS

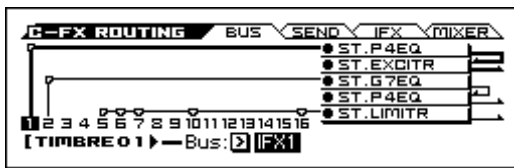

Specifies the bus where the program oscillator(s) used by timbres 1–16 will be sent.

Routing Map

This shows the status of the insert effects.

This area shows the insert effect routing (**Bus Select**), the name of the assigned effect, the on/off status, chaining, and the output bus that follows the insert effect. The type of insert effect, the on/off status, and the chain settings can all be edited in the C-ROUTING> IFX page.

Timbre 01...16 (Timbre Number)

To select a timbre (active timbre), place the cursor at one of the following parameters, and use the cursor buttons ◀▶ to switch timbres. The indication for the active timbre is highlighted. (see page 71)

Bus (Bus Select) [DKit, L/R, IFX1...5, Off]

This specifies the output bus for the timbre’s program oscillator.

L/R: Output to the L/R bus.

IFX1...5: Output to the IFX1–5 buses.

Off: The timbre will not be output from the L/R bus, or IFX1–5 buses. Choose the Off setting if you want the program oscillator output of the timbre to be connected to a master effect. Use SEND page Send1 (to MFX1) and Send2 (to MFX2) to specify the send levels.

Tip: You can create a wide variety of routings by using each timbre’s **Bus Select** and the **Chain to** and **Chain** settings (C-ROUTING> IFX) that follow the insert effect.

Example: Inserting a single IFX into multiple timbre

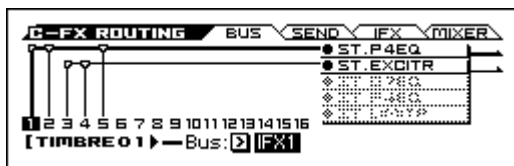

Example: Inserting a separate IFX into each timbre, and then inserting an IFX at the final stage

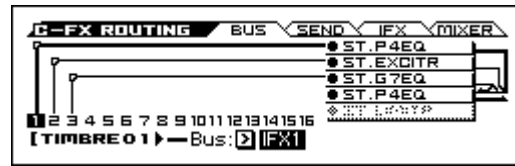

Example: Sharing a portion of a timbre’s IFX chain with another timbre

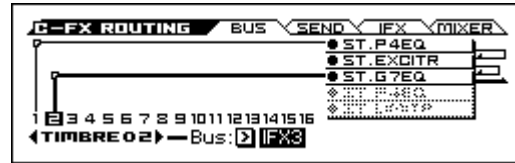

DKit: This can be selected only if the timbre’s program is a drum program (Oscillator Mode Drums).

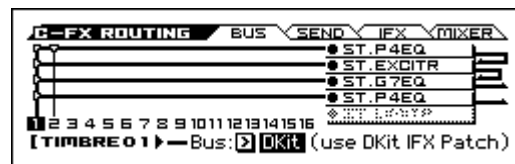

The **Bus Select**, **FX Control Bus**, **Send1**, and **Send2** (DRUMKIT> VOICE) settings for each key of the selected Dkit will be used. Check this setting if you want to apply an individual insert effect to each drum instrument.

Tip: In most preloaded drumkits, the drum instruments have the same **Bus Select** settings according to their type, as follows.

- Snares → IFX1
- Kicks → IFX2
- Cymbals → IFX3
- Tam, percussions, and others → IFX4

If you want to edit these routings, use the **Dkit IFX Patch** function. For more information, please see the “DKit IFX Patch” section on page 96.

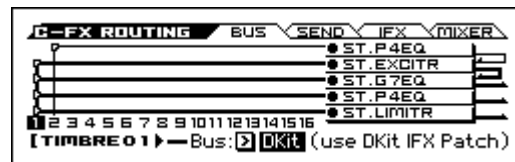
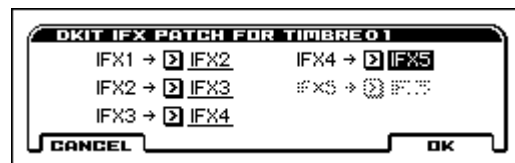

9-2: SEND

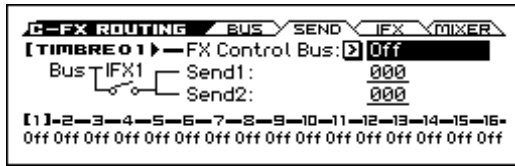

Timbre 01...16 (Timbre Number)

To select a timbre (active timbre), place the cursor at one of the following parameters, and use the cursor buttons ◀▶ to switch timbres. (see page 71)

FX Control Bus [Off, FC1, FC2]

Use the FX Control busses when you want a separate sound to control the audio input of an effect. You can use two FX Control busses (each is a two-channel mono bus) to control effects in various ways.

For more information, please see the “FX Control Bus” section on page 199.

Send1 (MFX1) [000...127]

Send2 (MFX2) [000...127]

For each timbre, these parameters set the send level to master effects 1 and 2. These settings are valid when **Bus Select** is set to L/R or Off. When IFX 1-5 are selected, the send levels to master effects 1 and 2 are set by the **Send1** and **Send2** parameters of the Insert FX Setup page, after the sound has passed through IFX1-5.

MIDI Control change CC#93 can be used to control the Send 1 level, and CC#91 to control the Send 2, and modify their respective settings. These messages will be received on the MIDI channel specified for each timbre in the C-TIMBER>MIDI page.

The actual send levels are determined by multiplying this value with the send level **Send1** and **Send2** (P-FX ROUTING>SEND) for each oscillator of the program selected for the timbre.

Timbre Info.

Shows the settings of timbres 1-16 for the parameter that you're editing.

Soloed timbres are indicated by (S).

Note: If this is disabled because of the setting of another parameter, “-” is shown.

9-3: IFX (Insert Effect Setup)

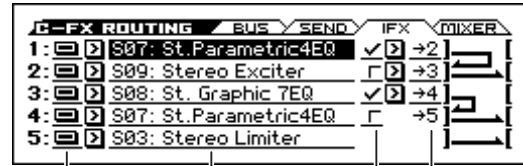

Here you can choose the type of each insert effect from 1 through 5, its on/off status, and chaining settings. For insert effects, the direct sound (Dry) is always stereo-in and out. The input/output configuration of the effect sound (Wet) depends on the effect type. For detailed explanations of the individual effects, please see the “Effect Guide” on page 197.

The following parameters are the same as in Program mode. For more information, please see the “16-3: Insert FX Setup” section on page 60.

However, unlike in Program mode, you can use a different MIDI channel to modulate each effect, if desired. This includes the post-IFX **Pan**, **Send1**, and **Send2** settings, as well as the effect's dynamic modulation (Dmod). To set the MIDI channel, use the **Ch** parameter on the IFX 1-5 page (C-IFX).

1 (IFX1)

Effect On/Off [Off, On]

Effect Select [000, S00...S63, D00...D10]

Category/IFX Select menu:

Chain [Off, On]

Chain to [2...5]

2 (IFX2)

Effect On/Off [Off, On]

Effect Select [000, S00...S61, D00...D10]

Chain [Off, On]

Chain to [3...5]

3 (IFX3)

Effect On/Off [Off, On]

Effect Select [000, S00...S61, D00...D09]

Chain [Off, On]

Chain to [4, 5]

4 (IFX4)

Effect On/Off [Off, On]

Effect Select [000, S00...S61, D00...D09]

Chain [Off, On]

5 (IFX5)

Effect On/Off [Off, On]

Effect Select [000, S00...S61]

These settings are the same as for a program.

See “16-3: Insert FX Setup” on page 60

9-4: MIXER

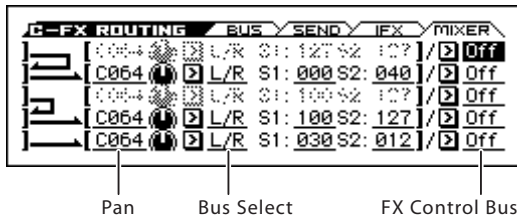

1...5 (IFX 1...5)

Pan	[L000...C064...R127]
Bus Select	[Off, L/R]
Send1	[000...127]
Send2	[000...127]
FX Control Bus	[Off, FC1, FC2]

These settings are the same as for a program.

See "16-4: MIXER" on page 61

9-1...4: FUNCTION

- 0: **Write Combination, Write/Initialize Combination** see page 94
- 1: **Solo Setting** see page 63
- 2: **Compare** see page 64
- 3: **Auto Song Setup** see page 64
- 4: **Add to Favorite** see page 94
- 5: **Copy from Program** see page 95
- 6: **Copy Insert Effect** see page 66
- 7: **Swap Insert Effect** see page 66
- 8: **DKit IFX Patch** see page 96 (only BUS page. If the program assigned to the timbre is a drum program and **Bus Select** is set to **DKit**.)

For more information, please see the "Combination: FUNCTION" section on page 94.

10: C-IFX

This page lets you edit the detailed parameters of the five insert effects. Use the C-FX ROUTING> IFX page to select IFX1 through IFX5.

10-1: IFX1 (Insert Effect1)

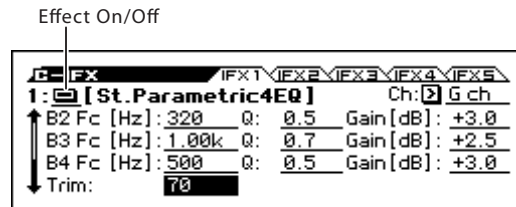

Effect On/Off [Off, On]

Turns the insert effect on/off. This is linked with the on/off setting in the C-FX ROUTING> IFX page.

Ch (Control Channel) [Ch01...16, G ch, All-R]

This parameter specifies the MIDI channel that will be used to control effect dynamic modulation (Dmod), pan following the insert effect (CC#8), Send 1 (CC#93), and Send 2 (CC#91).

The channel number of the timbre routed through this IFX will be followed by a "*" displayed at the right of Ch01-16. If two or more timbres with different MIDI channel settings are routed through the same IFX, this parameter specifies which of these channels will be used to control the effect.

G ch: The global **MIDI Channel** (G-MIDI> BASIC) will be used for control. Normally you will use the G ch setting.

All-R: The channel of any timbre routed through this effect can be used to control the effect. (Channels of each routed timbre will be indicated by "*".)

⚠ If a timbre is using a Drum program, and the timbre's **Bus Select** (C-FX ROUTING> BUS) is **DKit**, this affects the MIDI Control Channel as well. In this case, the timbre's MIDI channel will be used to control any effect where the Ch is set to **All-R**, regardless of the **Bus Select** (GLOBAL DRUM KIT> VOICE) settings or the settings of the **DKit IFX Patch** function.

IFX1 Parameters

This tab shows the parameters for IFX1, as selected on the C-FX ROUTING> IFX page.

For details on the specific parameters of each effect, please see p.207.

10-2: IFX2 (Insert Effect2), 10-3: IFX3 (Insert Effect3), 10-4: IFX4 (Insert Effect4), 10-5: IFX5 (Insert Effect5)

Here you can edit the effect parameters for insert effects 2-5 selected in the C-FX ROUTING> IFX page.

For more information, please see “10-1: IFX1 (Insert Effect1)” above.

✓ 10-1...5: FUNCTION

- 0: **Write Combination, Write/Initialize Combination** see page 94
- 1: **Solo Setting** see page 63
- 2: **Compare** see page 64
- 3: **Auto Song Setup** see page 64
- 4: **Add to Favorite** see page 94
- 5: **Copy from Program** see page 95
- 6: **Copy Insert Effect** see page 66
- 7: **Swap Insert Effect** see page 66

For more information, please see the “Combination: FUNCTION” section on page 94.

11: MFX (Master)

Here you can adjust settings for the master effects. For instance, you can:

- Select the master effects.
- Route a sound to the master effects.
- Create detailed settings for the master effects.

For more information, please see “Effect Guide” on page 197.

11-1: SETUP

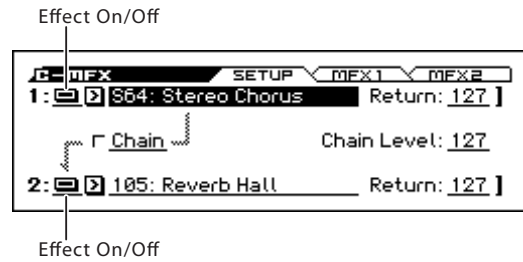

- Here you can specify the type of master effects used for 1, 2 and turn them on/off.
- The master effects are sent to the L/R bus.

1 (MFX1)

Effect On/Off	[Off, On]
Effect Select	[000, S1...S87, D00...D13]
Return 1	[000...127]
Chain On/Off	[Off, On]
Chain Level	[000...127]

2 (MFX2)

Effect On/Off	[Off, On]
Effect Select	[000, S1...S87, D00...D13]
Return 2	[000...127]

These parameters are the same as in Program mode.

For more information, please see the “18-2: MFX1 (Master Effect 1)” section on page 62.

11-2: MFX1 (Master Effect1)

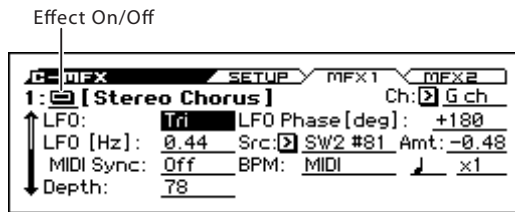

Here you can edit the parameters of the effect you selected for MFX1 in the C-MFX> SETUP page.

Effect On/Off [Off, On]

This turns master effect 1 on/off. This is linked with the on/off setting in the C-MFX> SETUP page.

Ch (Control Channel) [Ch01...16, G ch]

Specifies the MIDI channel that will control dynamic modulation (Dmod) for the master effect.

Ch01...Ch16: The specified MIDI channel will be used for control.

G ch: The global MIDI Channel (G-MIDI> BASIC) will be used for control. Normally you will use the G ch setting.

MFX1 Parameters

Here you can set the effect parameters of the insert effect you chose in the C-MFX>SETUP page.

For details on the master effects, please see the “Effect Guide” on page 197.

11-3: MFX2 (Master Effect2)

These pages let you edit the parameters of Master Effect 2. To select different effects types, use the C-MFX> SETUP page.

The parameters for MFX2 is the same as for MFX1.

For more information, please see “11-2: MFX1 (Master Effect1)” above.

11-1...3: FUNCTION

- 0: **Write Combination, Write/Initialize Combination** see page 94
- 1: **Solo Setting** see page 63
- 2: **Compare** see page 64
- 3: **Auto Song Setup** see page 64
- 4: **Add to Favorite** see page 94
- 5: **Copy from Program** see page 95
- 6: **Copy Master Effect** see page 66

For more information, please see the “Combination: FUNCTION” section on page 94.

Combination: FUNCTION

Procedure for each function

1. Press the FUNCTION button to open the function list.
2. Adjust settings in the dialog box.

For details on the settings in each dialog box, refer to the explanation of each function.

Press the OK button to execute, or press the Cancel button if you decide not to execute.

Write Combination, Write/Initialize Combination

Use these functions to save (write) an edited combination to internal memory. You can also initialize a user bank combination.

⚠ Be sure to **Write** any Combination that you wish to keep. If you turn off the power, or select another Combination before writing an edited Combination, it cannot be recovered.

For the procedure, refer to “Write Program, Write/Initialize Program” on page 63.



Solo Setting

This turns Solo on/off for each timbre. For more information, please see the “Solo Setting” section on page 63.

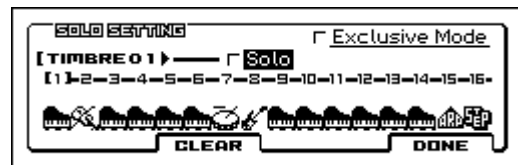

Compare

Use this function when you want to compare the sound of the combination you're editing with the sound prior to editing (i.e., the saved sound). This function is the same as in Program mode.

For more information, please see the “Compare” section on page 64.

Auto Setup Song

This function automatically copies the settings of the program or combination to a song, and enables the record-standby status

For more information, please see the “Auto Song Setup” section on page 64.

Add to Favorite

This function adds the program that you've selected in Program mode (or the combination that you've selected in Combination mode) to Favorites. This function is the same as in Program mode.

For more information, please see the “Add to Favorite” section on page 64.

Copy from Program

This function is available on every page in Combination mode. It copies Effects settings from a selected Program to the current Combination. This lets the Program sound the same as it did in Program mode.



1. Use **Program** to select the copy-source program.
2. Select the **IFXs**, **MFXs** options to specify which, if any, of the Program's effects settings to copy.

IFXs: The settings of all insert effect settings (the contents of the Insert FX setup page and the IFX1–5 effect parameters) of the copy-source program will be copied.

MFXs: All master effect settings of the copy-source program will be copied.

Bus Select settings made automatically when you execute Copy From Program

When you execute Copy From Program, each timbre's Bus Select setting is automatically set as follows according to various conditions.

- If IFX is checked, all IFX as well as the Bus Select setting of the copy-source will be copied to the copy-destination timbre. In addition, all timbres other than the copy-destination where Bus Select is set to IFX1–5 will be automatically changed to L/R.

Note: Note: Timbres other than the copy-destination that are set to Off or DKit will not be changed.

- If IFXs is unchecked, IFX and Bus Select settings will not be copied; the Bus Select of the copy-destination program will be automatically changed to L/R, regardless of whether it had been set to Off, IFX1–5, or DKit.

Note: Automatic settings will not be made for timbres other than the copy-destination.

- In addition to the above, if the copy-source program is a drum program and the P-FX ROUTING> BUS page DKIT-SET setting is checked, the copy-destination timbre's Bus Select will be set to DKit regardless of whether IFXs is checked. Also, the DKit IFX Patch setting will be reset to the default state.

3. If **StepSeq** is checked, the step sequencer settings of the copy-source program will also be copied. The step sequencer's drum program will be assigned to timbre 16.
4. If you check **"Arp,"** the Program's arpeggiator settings will also be copied.

If this is On (checked), the arpeggiator settings of the copy-source program will be copied to the "Arp" you specify in step 7, and that arpeggiator's **Arpeggiator Run** setting will be turned on and assigned to the copy-destination timbre ("Arpeggiator Assign").

5. If you check **"with Drum Track,"** the Drum Track Pattern settings of the copy-source program will also be copied.

If this is On (checked), the Drum Track Pattern settings of the copy-source program will be copied to the "Drum Track" you specify in step 8.

The MIDI channel specified for the Drum Track copy-destination timbre will be used.

6. Use the **To** field to specify the copy-destination timbre.

The parameters for each timbre will be initialized. The copy-source program will be assigned to **Program** (COMBI> PROG Program Select on page 71).

- The **MIDI Channel** (C–TIMBRE> MIDI) setting will not change if "Arp" is checked. If "Arp" is unchecked, **MIDI Channel** will be automatically set to G ch.
 - The **Status** (COMBI> PROG) setting will automatically be set to INT.
7. Use the **"Arp"** field to select the copy-destination arpeggiator; either **A** or **B**.
 8. Use the **"Drum Track"** to specify the destination timbre where the drum track program will be copied.

Hold Balance

1. Choose this function to turn it on (select the check mark).
2. When you adjust any timbre's volume setting, the other timbre volume settings will change to maintain the balance. This is convenient when you want to adjust the overall volume.

Detune BPM Adjust

Detune BPM Adjust is available on the C–TIMBRE> PITCH opage.

This function changes a loop's tempo by changing the Timbre's **Detune** parameter. The multisample data itself is not altered. Since this alters the pitch of the loop along with the tempo, it's generally intended for un-pitched percussive loops.

Note: Using **Detune BPM Adjust** will over-write any previous **Detune** settings.

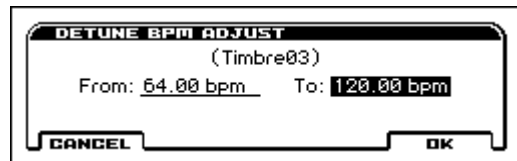

1. Go to the **Pitch** tab of the **Timbre Parameters** page.
2. Select the **Detune** parameter for the desired **Timbre**.

Detune BPM Adjust is available only when the **Detune** parameter has been selected. Otherwise, the menu selection will be grayed out.

1. In **From**, specify the loop's original BPM value. In **To**, specify the desired BPM value.

The appropriate **Detune** value will be calculated automatically from these two values.

2. For example, if you set **From** to 60 bpm and **To** to 120 bpm, **Detune** will be set to +1200 (one octave up).

Note: Since this function does not affect the multisample data itself, and always over-writes the previous **Detune** amount, using it repeatedly has no cumulative effect.

Copy Arpeggiator

Copy Arpeggiator is available on the COMBI> ARP and C–ARP pages.

This function can copy arpeggiator settings from another location to the current Combi.

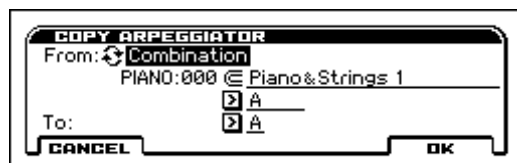

1. In **From**, select the source of the arpeggiator you wish to copy.

If you are copying from a Combination or Song, select either **A** or **B**, if you wish to copy settings from only one arpeggiator, or select **A&B** if you wish to copy the settings of both arpeggiators.

2. If you are copying from a Program, or are copying either **A** or **B** from a Combination, or Song, select either **A** or **B** as the To copy destination.

Copy Drum Track

Copy Drum Track is available on the C-DRUM TRACK pages.

This function copies the drum track settings of the specified Program, Combination, or Song.

For more information, please see the “Copy Drum Track” section on page 64.

Assign inst to Tone

Assign inst to Tone is available on the C-STEP SEQ pages.

Here's how to assign an instrument to each tone of the step sequencer. This function is the same as in Program mode.

For more information, please see the “Assign inst to Tone” section on page 65.

Edits Step Parameters

Edit Step Seq is available on the C-STEP SEQ pages.

Here you can specify velocity and accent on/off for each step. This function is the same as in Program mode.

For more information, please see the “Edits Step Parameters” section on page 65.

Copy Step Seq

Copy Step Seq is available on the C-STEP SEQ pages.

This function copies the step sequencer settings from the program, combination, or song that you specify. This function is the same as in Program mode.

For more information, please see the “Copy Step Seq” section on page 65.

Copy Insert Effect

Copy Insert Effect is available on the C-FX ROUTING and C-IFX pages.

This function copies effects settings from Program, Combination, or Song. For more information, please see the “Copy Insert Effect” section on page 66.

Note: The slot's MIDI control channel, as specified by the **Ch** parameter on the C-IFX> IFX1-5 pages, will not be copied.

Swap Insert Effect

Swap Insert Effect is available on the C-FX ROUTING and C-IFX pages.

This function swaps (exchanges) insert effect settings. For more information, please see the “Swap Insert Effect” section on page 66.

Note: The slot's MIDI control channel, as specified by the **Ch** parameter on the C-IFX> IFX1-5 pages, will not be swapped.

DKit IFX Patch

This patches the **Bus Select** settings for each key of a drum kit, temporarily changing the insert effect connection destinations.

You can execute this function if the program assigned to the timbre is a drum program and **Bus Select** is set to **DKit**. The **Bus Select** setting (GLOBAL DRUM KIT> VOICE) of each key in the drum kit must be set to one of IFX1-5.

1. In the C-FX ROUTING> BUS page, set the Bus Select parameter of the appropriate timbre to **DKit**.
2. Select “DKit IFX Patch” to open the dialog box.

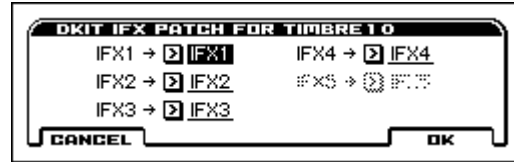

3. In the DrumKit “IFX” popup, select the output bus where you want to patch the signal: an insert effect or L/R or Off.

Note: To restore the condition of the drum kit, execute IFX1→IFX1, IFX2→IFX2, IFX3→IFX3, IFX4→IFX4, IFX5→IFX5 (see page 90).

Copy MFX

Copy MFX is available on the C-MFX pages.

This function copies effect settings from Program, Combination, or Song. For more information, please see the “Copy Master Effect” section on page 66.

Note: The slot's MIDI control channel, as specified by the **Ch** parameter on the P9: C-MFX> MFX1 and MFX2 page, will not be copied.

Extended combination functions

In addition to playing and editing combinations, the KROSS provides several convenient extended combination functions.

Auto song setup

The Auto Song Setup function automatically copies the settings of a program or combination to a song, and adjusts the necessary settings to prepare for recording. This lets you instantly capture your phrases or musical ideas as a song. (See page 101)

Audio input and audio recording

If you press the AUDIO IN button to turn on the audio input, you'll be able to play a program while singing into a mic or playing a vocoder program, or perform along with the playback from your audio player.

Note: The functions of SW1 and SW2 will be assigned for the program that was first selected. In conjunction with this, the combination's MIDI Filter settings may also be adjusted as necessary.

Sequencer mode

An overview of Sequencer mode

Sequencer Mode lets you record and play back MIDI data on sixteen MIDI tracks, using the internal sound generator or external sound modules.

The dual arpeggiator, drum track function, step sequencer function as well as the sophisticated effects, controllers, and the numerous other functions of the KROSS can be used together to give you a wide range of possibilities for music production or live performance.

 When you turn off the power, the Sequencer mode settings and the songs you've recorded will disappear. If you need to keep this data, you must save it to an SD card or a data filer (via MIDI Data Dump) before powering-off.

Use the function **Save Template Song function** if you want to save programs, track parameters, effects, etc. as a template song.

When you initially power up the KROSS it will not contain any song data, so if you wish to play back a song on the sequencer, you must first load data (see page 176, and page 109 of the Operation Guide).

MIDI sequencer

- The sequencer can record a maximum of 210,000 MIDI events, up to 128 songs, and as many as 999 measures per song.
- Timing resolution is a maximum of $\downarrow/480$.
- There are sixteen tracks for MIDI performance data, and a tempo track that controls the time signature and tempo.
- The arpeggiator can be used during playback or recording.
- You can perform or record using the Drum Track function.
- The Step Sequencer function can be used during playback or recording.
- For each song, you can use five stereo insert effects and two stereo master effects.
- Sixteen different preset template songs are built-in, and contain program and effect settings which are suitable for various musical styles. Up to sixteen original templates that you create can be saved as user template songs.
- A track play loop function lets you loop specified measures independently for each track.
- Preset patterns ideal for drums are built in. In addition, you can create up to 700 user patterns for each song. These patterns can be used as musical data within a song, or can be played by the drum track function.

MIDI recording features

- Various methods of recording are supported, including realtime recording, where your performance on the keyboard and controllers (including MIDI control events) is recorded as you play.
- The musical data and control events that you recorded can be edited in various ways (including event editing and many other edit commands).
- MIDI System Exclusive (SysEx) messages can be recorded and played back. SysEx messages received from an external MIDI device or parameter changes produced by editing track parameters or effect parameters can be recorded in real-time on any desired track.

Parameter-related features

- When the **Status** of a track is set to INT or BTH, an external sequencer can be used to play the KROSS as a multi-timbral tone generator. When the **Status** of a track is set to BTH, EXT, or EX2, the sequencer of KROSS can play external tone generators.
- **Tone Adjust** parameters let you make temporary adjustments to the sound of the program used by a track, while leaving the original program unchanged. While creating a song, you can use this capability to make changes in realtime by (for example) softening the tone of the bass sound or sharpening the attack of the strings without having to return to Program mode to edit the program itself.
- KROSS's AMS (Alternate Modulation) capability lets you use control changes for Realtime Controls of the parameters of the programs used in a program. Its MIDI Sync abilities let you synchronize the LFO speed to changes in the tempo.
- Dmod (Dynamic Modulation) functionality lets you control effect parameters in realtime. You can also use MIDI Sync to synchronize the LFO speed or delay time to changes in the tempo.
- The MIDI clock master can be set to Internal, External, or Auto, allowing synchronized performance with an external MIDI device.

Editing and operation features

- The Auto Song Setup function lets you instantly set up program or combination settings of Program mode or Combination mode as a song, so that you can start recording simply by pressing the START/STOP (▶/■) button. Since performances using the Drum Track function, Step sequencer or Arpeggiator in Program or Combination mode are seamlessly integrated with song production, any inspiration or ideas for phrases and songs that occur to you while playing can be immediately be turned into a song.
- Program and Combination settings can be copied to a song.
- Sequencer data such as a song that you create can be saved in the KROSS's native format, or transmitted as a MIDI data dump.
- A song you created can be converted into SMF (Standard MIDI File) data. SMF songs can also be loaded.
- The **Play/Rec/Mute** let you instantly play/mute any desired track on the fly.
- You can rewind or fast-forward MIDI Tracks while listening to the sound.
- You can assign names to the song and also to each track.
- The LOCATE button lets you move quickly to a desired location.

Setup parameters & Musical data

Each song consists of MIDI tracks 1–16, a tempo track as well as various song parameters such as the song name, settings for the arpeggiator, drum track function, step sequencer function, and effect settings.

Up to 128 such songs can be created in the KROSS.

MIDI tracks 1–16 each consist of “track parameters” that specify the starting state of the track, and “playback data.” The tempo track consists of tempo and time signature data.

MIDI tracks 1–16

Setup parameters

Bank/Program No.*, Play/Rec/Mute, Pan*, Volume*, Tone Adjust*, Track Play Loop, Loop Start Measure, Loop End Measure, Play Intro, Status, MIDI Channel, Bank Select (When Status=EX2), Force OSC Mode, OSC Select, Portamento*, Transpose**, Detune**, Bend Range**, Use Program’s Scale, Delay (Mode, Time, Base Note, Times), MIDI Filter, Keyboard Zone, Velocity Zone, Track Name, Bus Select, FX Control Bus, Send1(MFX1)*, Send2(MFX2)*, Drum Kit IFX Patch

Musical data

Note On/Off
Program Change (including Bank Select)
Pitch Bend
After Touch
Control Change
Exclusive Message

Tempo track

Setup parameters/Musical data

Time signature*, Tempo*

* When you change the setting during realtime-recording, this will be recorded as musical data (Program change and Control change messages). This allows the initial settings to be modified during the playback.

**Musical data (MIDI RPN data) can be used to change the initial settings during playback.

Other parameters: You can adjust parameters during realtime recording and record these changes as MIDI System Exclusive messages. This means that the settings at the start of playback can change as the song progresses.

- For details on Control Change messages and RPN, please see “Control change” on page 301, and “Using RPN (Registered Parameter Numbers)” on page 303.
- For details on MIDI System Exclusive messages, please see “System Exclusive events supported in Sequencer mode” on page 152.

The Global mode “SEQ Mode” setting

In Sequencer mode you will normally use the internal sequencer as the master that controls the internal sound generator or external MIDI sound modules. However, you can also use the KROSS as a multi-timbral sound module that can simultaneously play multiple tracks of performance data from an external MIDI sequencer. (Normally you’ll use Combination mode if you want to use the KROSS as a master keyboard.)

You can switch the KROSS’s setting as appropriate for these two purposes. This setting is made in G–MIDI> OUT page SEQ Mode **Track MIDI Out**.

“for Master” is the appropriate setting if you want to use the KROSS’s internal sequencer to control an external sound module, or use the KROSS in Sequencer mode as a master keyboard. In this case when you switch songs on the KROSS, tracks where the **Status** is set to EXT or BTH can transmit MIDI messages such as program changes to set up your external MIDI sound module.

“for External-Sequencer” is the appropriate setting if you want to use the KROSS as a multi-timbral sound module for your external sequencer. When you switch songs on the KROSS, MIDI messages such as program changes will not be transmitted (by tracks whose **Status** is EXT or BTH). This ensures that echo-back from your external MIDI sequencer will not cause KROSS tracks of the corresponding MIDI channel to switch their program, pan, or volume settings.

Auto Song Setup

The Auto Song Setup function copies the settings of a program or combination to a song, and puts you in record-ready mode. Then you can simply press the START/STOP (▶/■) button to begin recording immediately. This lets you seamlessly move from playing a program or combination to producing a song. For example, if you've been using the drum track or arpeggiator and have come up with a phrase or an idea, this function lets you easily turn your inspiration into a song.

Procedure (example: Combination mode)

1. Enter Combination mode.
2. In COMBI page, select the desired combination and edit the Arpeggiator etc. as desired.

Note: If you want to save the edited state of the combination, use the Write Combination function.

3. Press the REC (●) button. Alternatively, select the function "Auto Song Setup."

The Setup to Record dialog box will appear.



4. To execute the Auto Song Setup function, press the REC (●) button or the OK (MENU) button. If you decide not to execute, press the Cancel button.

You will automatically move to Sequencer mode, and the settings of the combination will be copied to the song.

The first unused song will be the copy-destination song.

Contents automatically copied from a combination

The copied contents will be the same as when you execute the function Copy From Combination with the following settings in the dialog box. (see page 138)

- IFXs, MFXs checked
- Auto Adjust Arp setting for Multi REC checked

Contents automatically copied from a program

The result will be the same as if you used the Copy From Program function and MULTI REC with the following settings.

(see page 95)

- IFXs, MFXs checked
 - StepSeq checked
 - Arp checked
 - To set to Track 01
 - Arp set to A
 - Check the Drum Track check box, and choose Track 10
 - Check Recording Setup Multi REC
 - Set the Play/Rec/Mute setting to REC for tracks 01, 10 and 16 (see page 110).
5. The KROSS will automatically enter record-ready mode, and the metronome will sound according to the Metronome setting (SEQ> REC).
 6. Press the START/STOP (▶/■) button to begin realtime recording. To stop recording, press the START/STOP (▶/■) button once again.

The Undo function

When you perform realtime recording, or track editing, this function allows you to make before-and-after comparisons.

If you record when the Undo function is on (checked), Undo will be turned off. That musical data now becomes the musical data that will be selected when Undo is off.

Operations where Undo is available

In general, track event data can not be returned to its original state.

Comparing song parameters is possible only during song editing (when executing a function).

- Recording to a MIDI track
- Track Edit
 - All commands except for the following functions: **Memory Status, Link Edit Measure to Current, Solo Setting, FF/REW Speed and Set Location** of the S-TRACK EDIT page.
- Song Edit
 - SEQ-S-MIDI pages: **Delete Song** and **Copy From Song** functions

The program will not be affected by the Undo, and will not return to its prior state.

Operations where Undo is not available

- Editing song parameters
- functions other than those listed under "Operations for which Undo is available" above.

SEQ Page Select

Here's how you can select each page.

- Use the PAGE+/- buttons.
- Press the MENU button to access the page menu, use the PAGE+/- buttons to select a page, and press the MENU (OK) button or the ENTER button.
- While the above page menu is displayed, press the FUNCTION (TABS) button, then use the PAGE+/- buttons to select a page by its tab, and then press the MENU (OK) button or the ENTER button.
- Hold down the MENU button and press the PAGE- or PAGE+ buttons.

For details, see “Selecting pages and tabs” on page 11.

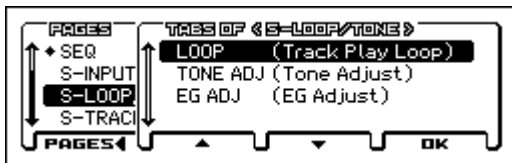

Page	Tab	Main content
SEQ	MAIN	Song selection, recording/playback, and tempo setting (see page 103)
	PROG	Program selection for each track (see page 105)
	MIX	Pan and volume settings etc. for each track (see page 106)
	REC	Recording method selection (see page 107)
	ARP	Simple arpeggiator editing (see page 111)
S-INPUT/CTRL	AUDIO IN	External audio input settings (see page 112)
	CONTROLLERS	SW1, 2, and tempo settings (see page 112)
S-LOOP/TONE	LOOP	Loop settings for each track (see page 113)
	TONE ADJ	Tone Adjust editing (see page 114)
	EG ADJ	EG (ADSR) editing (see page 115)
S-TRACK	MIDI	MIDI channel setting for each track (see page 116)
	OSC	OSC setting for each track (see page 116)
	PITCH	Pitch setting for each track (see page 117)
	SCALE	Scale setting for each track (see page 118)
S-ZONE/DELAY	KEY ZONE	Key zone and velocity zone (see page 118)
	VEL ZONE	
	DELAY	Time delay from note-on to beginning of sound. (see page 120)
S-MIDI FILTER	1, 2, 3, 4	MIDI transmit/receive filter settings. (see page 116)
S-TRACK EDIT	SELECT TO MEASURE TO EDIT	Edit operations such as copying or deleting a track, quantizing, or event editing (see page 124)
S-ARP	ASSIGN	Arpeggiator assignments to each timbre (see page 125)
	A	Arpeggiator A settings (see page 126)
	B	Arpeggiator B settings (see page 126)
	SCAN ZONE	Arpeggiator trigger region settings (see page 127)
S-DRUM TRACK	PATTERN	Drum Track pattern selection and trigger region settings (see page 127)
	CHANNEL	Drum Track input/output MIDI channel settings (see page 128)
S-STEP SEQ	BASIC	Step sequencer program selection and length settings (see page 130)
	EDIT	Step on/off entry (see page 130)
	INST	Instrument settings (see page 131)
	MOD	Step sequencer settings such as accent and swing (see page 131)
S-FX ROUTING	BUS	Bus assignments from each timbre to the insert effects (see page 132)
	SEND	Send amounts from each timbre to the master effects (see page 132)
	IFX	Insert effect type selection and chain settings (see page 133)
	MIXER	Post-insert effect routing settings (see page 134)
S-IFX	IFX1, 2, 3, 4, 5	Insert effect 1–5 settings (see page 134)
S-MFX	SETUP	Master effect type selection and chain settings (see page 135)
	MFX1, 2	Master effect 1 and 2 settings (see page 136)

0: SEQ

0-1: MAIN

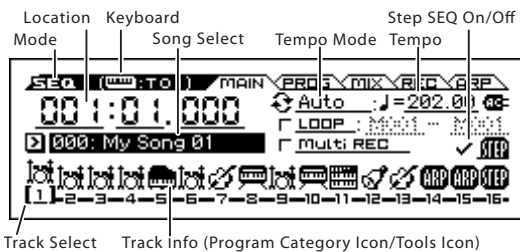

Here you can create basic settings for MIDI track recording and playback, and you can select the program that will be used by each track.

Location [001:01.000...999:16.479]

This display shows the current position in the song.

From the left, the numbers are the measure (001–999), beat (01–16), and clock (000–479). When you modify these values, the current location will change.

MIDI When **MIDI Clock** (G–MIDI> BASIC) is set to **Internal** (or **Auto**, if no MIDI clocks are being received), the KROSS will transmit Song Position Pointer messages when the **Location** is changed.

Also, if the **MIDI Clock** parameter is set to **External MIDI** (or **Auto**, if MIDI clocks are currently being received), and **Receive Ext. RT Cmd (Realtime Commands)**(G–MIDI> BASIC) is on, the **Location** will change in response to received Song Position Pointer messages.

The range where the beat and clock can be modified will depend on the currently specified time signature.

Song Select [000...127]

Select the song that you want to record or play back.

Creating a new song

Execute the Create New Song function. In the dialog box, use Set Length to specify the number of measures in the song that you want to create. If necessary, use “Select the number” to specify the song number that you want to create. Press the OK button. (see page 137)

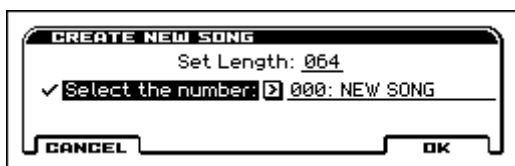

Note: If you want to change the length after creating the song, execute the Set Song Length function in the S–TRACK EDIT page. When creating a new song, you can specify the length to be somewhat longer than necessary, and after you have finished recording and editing, use **Set Song Length** to specify the correct length.

MIDI A Song Select message is transmitted when you switch songs on the KROSS. You can switch songs on the KROSS remotely, by sending a Song Select message from an external MIDI device.

If **Track MIDI Out** (G–MIDI> BASIC) is set to “for Master,” and the song is switched, tracks whose track status (SEQ> PROG) is EXT, EX2, or BOTH will transmit Bank Select, Program Change, Volume, Panpot, Portamento, Send 1/2, Post IFX Pan, and Post IFX Send 1/2 messages on the MIDI channel of that track. These messages will not be transmitted if **Track MIDI Out** is set to “for External Seq.”

Tempo Mode

[Auto, Manual, REC]

Auto: The tempo will follow the tempo of the tempo track. You'll be able to specify the tempo either by using the Create/Erase Control function tempo (for All) or as described below in “Changing the tempo.” When Auto is selected, it will not be possible to modify the **Tempo** setting while a song is playing or recording (or during standby).

Manu (Manual): The **Tempo** setting will be used.

REC: Tempo changes will be recorded on the TempoTrack.

Tempo [040.00...300.00, EXT]

This specifies the tempo of the song. This tempo applies to song playback, arpeggiator, drum track, step sequencer, tempo-synced LFOs, and tempo-synced effects.

040.00...300.00: When the **Tempo Mode** is Manu (Manual), this tempo will be used for recording and playback. When **Tempo Mode** is REC, this tempo will be recorded on the tempo track.

EXT: This will appear when the **MIDI Clock** (G–MIDI> BASIC) is set to either External MIDI, External USB or Auto. The tempo of the internal sequencer will synchronize with MIDI Clock messages received from an external sequencer or other MIDI device.

If **MIDI Clock** is set to **Internal**, the above tempo setting (040.00–300.00) is used. If you've selected Auto, operation will automatically switch from Internal to External if MIDI Clock data is received from an external MIDI device. This indication will appear.

Note: You can also adjust this by turning the TEMPO knob. Alternatively, you can set the tempo by pressing the TAP button at the desired interval.

Note: If you've selected Tempo as an alternate modulation source or a dynamic modulation source, ♩=120.00 will be the reference.

To record tempo changes

First, set **Track Select** to a MIDI Track.

Press the REC (●) button to enter recording-standby mode, you will be able to select REC.

Set **Tempo Mode** to REC, start recording, and change the **Tempo** value. Turn the TEMPO knob to specify the tempo. You can also change the tempo by repeatedly pressing the TAP button at the desired interval.

This cannot be selected when the REC page item **Recording Setup** is set to Loop All Tracks.

When you change the **Tempo** value while recording, the tempo changes will be recorded, causing the tempo to change as the song progresses.

Tempo changes can also be created using the **Event Edit** or **Create/Erase Control** functions.

Note: If you wish to record only the tempo changes, set **Recording Setup** (SEQ> REC) to Overdub, and the tempo will be recorded on the tempo track without being affected by the musical data of **Track Select**.

Loop (Loop All Tracks)

[Off, On]

The specified region of measures will repeat during playback or recording. This is linked with LOOP in the SEQ> REC page. (see page 108)

On (checked): That track will loop between **Loop Start Measure** and **Loop End Measure**.

Loop Start

[M001...M999]

Specifies the first measure of the loop.

Loop End

[M001...M999]

Specifies the last measure of the loop.

Multi REC

[Off, On]

Select this if you want to record two or more tracks simultaneously. It is linked with the on/off setting in the SEQ> REC page. (see page 109)

Battery/AC Icon

[🔋, 🔌, 🔌]

Indicates the power supply and the remaining battery capacity. (see page 2)

STEP SEQ On/Off

[Off, On]

This specifies whether track 16 is used for the step sequencer or as a conventional track.

On (checked): Track 16 is used for the step sequencer. In this case, a drum program is assigned to track 16.

Off (unchecked): Track 16 is used as a conventional track.

 If this is On, a drum program is assigned automatically. Even if you then turn this Off again, the drum program will still be assigned. Select the program that you want to use as a conventional timbre.





It is linked with the on/off setting in the SEQ> PROG page.

Track Info

The following information is shown for each track.

- The category of the program  etc. that's assigned to the timbre
SEQ> PROG page Status: when set to INT, BTH
SEQ> MIXER page Sound: when set to Play

Note: INT is shown if the User category is selected.

- Mute 
SEQ> PROG page Status: INT, BTH
SEQ> MIXER page Sound: when set to Mute
- Dummy arpeggiator  (see page 138)
SEQ> PROG page Status: Off
SEQ> ASSIGN page ARP Assign: when set to A or B
- Step sequencer 
COMBI> PROG page STEP SEQ On/Off: when set to On
- Status **OFF**
COMBI> PROG page Status: when set to Off, EXT, or EX2
- Solo On 
Indicates that the Solo function is on

Track Select

[01...16]

Select the MIDI track that you want to record.

01...16: Select the track that you want to record or edit. Use the cursor buttons ◀ ▶ to make the selection.

When **Multi REC** is off, this also selects the record-enabled track.

When **Multi REC** is on, the **Play/Rec/Mute** buttons (SEQ> REC) select the record-enabled tracks, regardless of the **Track Select** setting.

 If other tracks are set to the same MIDI channel as the selected track, and their **Status** is set to INT or BTH, they'll be controlled by the keyboard as well.

Additionally, other tracks set to the same MIDI channel as the selected track, and their Status set to EXT, EX2, or BTH, will transmit MIDI to external devices. For another look at this, please see the table below.

MIDI Channel	Status	Keyboard plays Internal Sounds	Keyboard Transmits MIDI Out
Same as the selected MIDI Track	OFF	No	No
	INT	Yes	No
	EXT	No	Yes
	EX2	No	Yes
	BTH	Yes	Yes
Different from the selected MIDI Track	Any setting	No	No

Keyboard

This shows the number of the track that will sound when you play the keyboard.

0-2: PROG (Track Program)

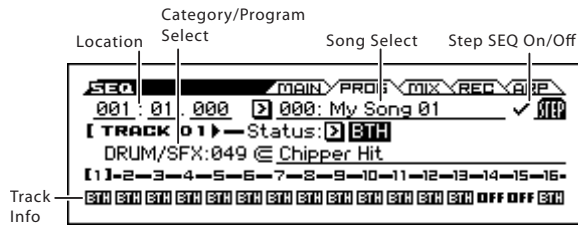

Location [001:01.000...999:16.479]

This display shows the current position in the song. (see page 103)

Song Select [000...127]

Select the song that you want to record or play back. (see page 103)

STEP SEQ On/Off [Off, On]

This specifies whether track 16 is used for the step sequencer or as a conventional track. (see page 104)

Track 01...16 (Track Number)

To select a track, place the cursor at one of the following parameters, and use the cursor buttons ◀ ▶ to switch tracks. The selected track is called the “active track,” and is indicated by square brackets [].

Note: If the song is stopped, this is synchronized with Track Select.

Status [Off, INT, BTH, EXT, EX2]

This sets whether the Track controls the internal sounds, external MIDI devices, or both.

When controlling external MIDI devices, it also allows you to choose the internal Bank Select numbers (as set by the front-panel buttons), or use custom Bank Select settings to match the external device.

Off: Use this to disable the Track. With this setting, the Track’s Program will not sound, and MIDI data will not be transmitted.

INT: The track will sound when you play back the performance data recorded on the MIDI track. If you use **Track Select** to select a MIDI track that is set to INT, the KROSS’s sound generator will produce sound when played. MIDI data will not be transmitted to an external device.

BTH: Both INT and EXT are operative. When the musical data recorded in the MIDI track is played back, or when you select a MIDI track that is set to BTH and play the controllers of the KROSS, the internal tone generator of the KROSS will sound, and MIDI data will also be transmitted to an external device.

EXT: When the musical data recorded in the MIDI track is played back, or when you select a MIDI track that is set to EXT and play the controllers of the KROSS, MIDI data will be transmitted to an external device, but the internal tone generator of the KROSS will not sound.

When you select another song or return to the beginning of the song, the program change, volume, pan pot, portamento, sends 1 and 2, post IFX pan, and post IFX sends 1 and 2 of each MIDI track set to EXT will be transmitted via MIDI. (See G-MIDI> OUT: SEQ Mode “Track MIDI Out” on page 161)

EX2: The values of Bank Select MSB and Bank Select LSB (S-TRACK> MIDI) will be effective. Instead of the program bank numbers A-g(d) that can be selected on the KROSS, the bank number specified by Bank Select will be transmitted via MIDI. The rest is the same as for EXT.

MIDI MIDI data is transmitted and received on the MIDI channel that is specified separately for each MIDI track by the **MIDI Channel**.

Status	Keyboard, Sequencer, & MIDI In play Internal Sounds	Keyboard & Sequencer Transmit MIDI Out
OFF	No	No
INT	Yes	No
EXT	No	Yes (using the Bank Select message of the track’s Program)
EX2	No	Yes (using the Bank Select message specified on the MIDI tab of the Track Param page)
BTH	Yes	Yes

Category: Index No. [PIANO...USER: 000...127]

Program Select [Program name]

Selects the program that will be used by each MIDI track.

The lower line displays part of the program name.

The program that you select here will be used when the song is played or recorded from the beginning. If the program is changed while recording, the program change will be recorded as MIDI data, and the program will change during playback. You can also change the program manually during playback. However, the program will change at any point where program change data is already recorded.

MIDI If the **Status** is either INT or BTH, programs can be selected by receiving MIDI program change messages. Also, when the song is changed or when the song returns to the beginning, tracks where the **Status** is EXT, EX2 or BTH will transmit the bank and program numbers via MIDI. Tracks where the **Status** is EX2 will show Bank as “-” and will transmit the bank number that was selected in the **Bank Select** (S-TRACK> MIDI) parameter. (see “Track MIDI Out” on page 161)

Various ways to change the program for a track

- Choose **Program Select**, and turn the VALUE dial or use the ▲/▼ buttons.
- If you’ve chosen **Program Select** and use the sound selector list (see “Sound select list” on page 70).
- Transmit MIDI program change messages from a connected external MIDI device (if the track **Status** is INT or BTH).

Note: MIDI program changes are transmitted using the Bank No. that’s specified in Program mode. This is a different number than the Category Index No. shown on this page. Please be aware of this.

- You can also use the above methods to **switch programs while a song is playing**. If you switch programs while recording, the program change data will be recorded, and the program will switch at that point in the song during playback. You can also use the function **Event Edit** to add program change data to a track.

Track Info.

Shows the settings of tracks 1-16 for the parameter that you’re editing.

Note: If this is disabled because of the setting of another parameter, “-” is shown.

0-3: MIX (Track Mixer)



Here you can set the pan and volume of each MIDI track.

The pan and volume that you specify here will be used when you play back or record from the beginning of the song. If you change the settings during recording, the changes will be recorded as MIDI data, and pan and volume will change during playback. You can also change the settings during playback. However, when the song reaches a location where pan or volume data was recorded, the settings will change accordingly.

Track 01...16 (Track Number)

To select a track, place the cursor at one of the following parameters, and use the cursor buttons ◀ ▶ to switch tracks. (see page 105)

Sound

[Play, Mute]

This determines whether or not the Track will sound.

Play: The track will sound.

Mute: The track will not sound.

Pan

[RND, L001...C064...R127]

Here you can set the pan for each MIDI track.

L001...C064...R127: A setting of L001 is far left and R127 is far right. A setting of C064 will reproduce the oscillator pan setting of the Program mode.

If a mono insert effect is in use, the settings you make here will be ignored. In this case, the **Pan: #8** parameter in S-FX ROUTING >MIXER page will adjust the panning of the sound after the Insert Effect. For more information, please see the "Mixer" section on page 202..

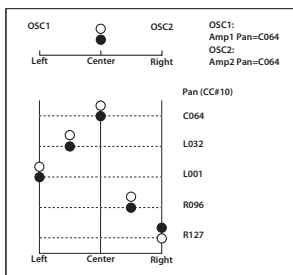
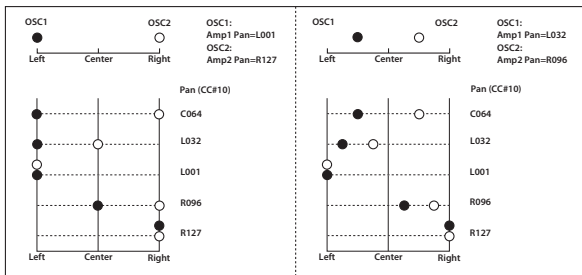

Random: The pan position will change randomly at each note-on.

MIDI If **Status** (SEQ> PROG) is INT or BTH, CC#10 Pan can be received to control the panning. When receiving CC#10, a value of 0 or 1 is far left, 64 is center, and 127 is far right. When you change the song or return to the beginning of the song, tracks where the **Status** is EXT, EX2 or BTH will transmit the pan you specify here as a MIDI message (except

for RND). (See G-MIDI> OUT SEQ Mode "Track MIDI Out" on page 161)

Volume

[000...127]

Here you can set the volume of each MIDI track.

MIDI When **Status** (SEQ> PROG) is INT or BTH, CC#7 Volume can be received to control the volume. The volume of a track is determined by multiplying the MIDI Volume (CC#7) and Expression (CC#11) values. When you change the song or return to the beginning of the song, tracks where **Status** is EXT, EX2 or BTH will transmit the volume you specify here as a MIDI Volume message. (See G-MIDI> OUT SEQ Mode "Track MIDI Out" on page 161)

Track Info.

Shows the settings of tracks 1-16 for the parameter that you're editing.

Note: If this is disabled because of the setting of another parameter, "-" is shown.

0-4: REC (Recording Setup)

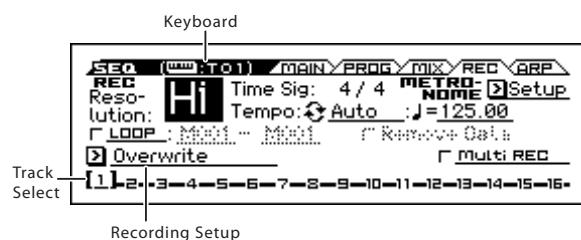

Here you can specify the realtime recording method, adjust levels and other settings for audio recording, and adjust the metronome settings.

Keyboard

This shows the number of the track that will sound when you play the keyboard.

Track Select [01...16]

Track01...Track16: Select the track that you want to record or edit. Use the cursor buttons ◀ ▶ to make the selection.

Soloed tracks are indicated by (S).

REC

Resolution (Realtime REC Quantize Resolution)

[Hi, $\frac{1}{3}$, $\frac{1}{4}$, $\frac{1}{8}$, $\frac{1}{16}$, $\frac{1}{32}$, $\frac{1}{64}$]

With realtime-recording, the timing of the MIDI data you play can be corrected.

Hi (High Resolution): Timing will not be corrected. Data will be recorded at the maximum resolution (1/480).

$\frac{1}{3}$ - $\frac{1}{4}$: Data will be corrected to the nearest interval of the specified timing as it is recorded. For example if you select $\frac{1}{3}$, data will be corrected to the nearest 32nd-note triplet interval. If you select $\frac{1}{4}$, data will be corrected to the nearest quarter note interval.

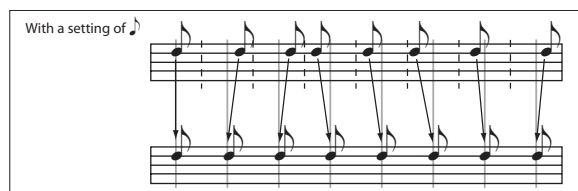

Because all the MIDI data being recorded will be corrected to the specified timing resolution, coarse settings of this parameter will cause continuous controllers such as pitch bend to be recorded in “stair-step” fashion.

In such cases, use a setting of Hi to record, and then use the **Quantize** function to correct only the desired type of data (notes etc.). To avoid a stiff feel, avoid recording at a low resolution to begin with.

Recording Setup

Selects the method of realtime recording

Overwrite

When recording for the first time, you will normally select this method.

If you use this method to record on a track where data has already been recorded, all previous data will be replaced from the measure where you began recording through all subsequent measures.

With this method, the newly recorded data overwrites musical data previously recorded on that track.

You will use this method to record, and then modify the results by using other types of realtime recording or MIDI event editing.

1. Use **Track Select** to choose the track that you want to record.
2. Set the **Recording Setup to Overwrite**.



3. Select the **MAIN** page, and use **Location** to specify the measure where recording will start.
4. Press the **SEQUNCER REC** (●) button, and then press the **START/STOP** (▶/■) button.

If the **Metronome Setup** is still set to the default settings, the metronome will sound for a two-measure pre-count, and then recording will begin.

Play the keyboard and move the controllers (such as the modulation wheel) to record your performance.

5. When you finish playing, press the **START/STOP** (▶/■) button.

Recording will end, and the location will return to the point at where you begin recording.

If you press the **PAUSE** (||) button instead of the **START/STOP** (▶/■) button, recording will pause. When you press the **PAUSE** (||) button once again, recording will resume. When you are finished, press the **START/STOP** (▶/■) button to stop recording.

Overdub

Select this method when you wish to add data to a previously-recorded track.

With this method, the newly recorded musical data is added to the existing data.

When you perform overdub recording on a previously-recorded track, the newly recorded data will be added to the previously-recorded data.

It is best to select this mode if you will be recording additional control data, recording a drum pattern, or recording the tempo in the tempo track. With this mode, data can be added without erasing the existing performance data.

1. Use **Track Select** to choose the track that you want to record.
2. Set the **Recording Setup to Overdub**.



3. For the rest of the procedure, please see steps 3-5 of “Overwrite.”

Manual Punch In

Choose this method if you want to partially rewrite the data of a previously recorded track.

While the song is playing, you can press the **SEQUNCER REC** (●) button or a connected pedal switch at the desired location to start or stop recording. With this method, the musical data previously on the track is overwritten by the newly recorded data.

1. Use **Track Select** to select the track that you want to record.
2. Set the **Recording Setup to Manual Punch In**.



3. Select the MAIN page, and use Location to move to a measure that's several measures earlier than where you want to start recording.

4. Press the START/STOP (▶/■) button.

Playback will begin.

5. At the point where you wish to begin recording, press the SEQUENCER REC (●) button.

Recording will begin. Play the keyboard and use the controllers such as the modulation wheel to record your performance.

6. When you finish recording, press the SEQUENCER REC (●) button.

Recording will end (playback will continue).

Note: Instead of pressing the SEQUENCER REC (●) button in steps 5 and 6, you can use a foot switch connected to the ASSIGNABLE SWITCH jack.

Set the G-INPUT/CTRL> FOOT page **Foot Switch Assign** to Song Punch In/Out.

7. Press the START/STOP (▶/■) button.

Playback will stop.

Auto Punch In

Select this method when you wish to automatically re-record selected portions of a previously-recorded track.

Recording will occur only over the specified area, rewriting it with the newly recorded data.

First you must specify the area that will be re-recorded. Then recording will automatically start and end within the specified area. With this method, the musical data previously on the track is overwritten by the newly recorded data.

1. Use Track Select to choose the track that you want to record.

2. Set the Recording Setup to Auto Punch In.



3. In "M (Auto Punch In Start Measure), "M (Auto Punch In End Measure)" specify the area that you wish to record.

For example, if you specify M005–M008, recording will occur only from measure 5 to measure 8.

4. Select the MAIN page, and use Location to specify a location several measures before the point where you wish to begin recording.

5. Press the SEQUENCER REC (●) button, and then press the START/STOP (▶/■) button.

Playback will begin.

When you reach the starting location you specified in step 3, recording will begin. Play the keyboard and use the controllers such as the modulation wheel to record your performance. When you reach the ending location you specified in step 3, recording will end. (Playback will continue.)

6. Press the START/STOP (▶/■) button.

Playback will stop, and you will return to the location you specified in step 4.

Auto Punch In Start Measure

[M001...M999]

Auto Punch In End Measure

[M001...M999]

When **Recording Setup** is set to Auto Punch In, specify the measures where recording will start and end.

LOOP (Loop All Tracks)

[Off, On]

Select this method when you wish to repeatedly record a specified area of a track, and continue adding data. This is suitable for creating drum patterns, etc.

1. Use Track Select to select the track that you want to record.

2. Check LOOP.



3. In "M (Loop Start Measure), "M (Loop End Measure)" specify the area that you wish to record.

For example, if you specify M004–M008, recording will occur repeatedly (as a loop) from measure 4 to measure 8.

4. In "Location," specify a location several measures earlier than the point where you wish to begin recording.

5. Press the SEQUENCER REC (●) button, and then press the START/STOP (▶/■) button.

Playback will begin. When you reach the starting location you specified in step 3, recording will begin. Play the keyboard and use the controllers such as the modulation wheel to record your performance.

When you reach the ending location which you specified in step 3, you will return to the starting location, and continue recording.

6. The musical data that is loop-recorded will be added to the previously-recorded data.

You can also erase specific data while you continue loop recording. This is useful if, for example, you need to delete a mistake without interrupting the flow of the recording.

If you press the SEQUENCER REC (●) button during loop recording, all musical data will be removed from the currently selected track as long as you continue pressing the switch.

If the **Remove Data** check box is selected in the REC page, you can delete just the data of a specific note number by holding down its key (note number) during loop recording.

In the same way, bend data will be deleted while you hold the pitch bend wheel in a position other than the center.

When you are once again ready to record musical data, uncheck the **Remove Data** check box.

7. Press the START/STOP (▶/■) button.

Playback will end, and you will return to the recording start location that you specified in step 4.

If Loop All Tracks is selected, normal playback will be looped as well.

Loop Start Measure

[M001...M999]

Loop End Measure

[M001...M999]

Specifies the range of measures where recording will repeat when **Recording Setup** is set to Loop All Tracks.

Remove Data

[Off, On]

Use this to delete unwanted MIDI data that you recorded while using Loop All Tracks. This is available when **Recording Setup** is set to Loop All Tracks.

On (checked): You can delete unwanted MIDI data while recording with Loop All Tracks. During recording, press the key (note number) that corresponds to the MIDI note data you wish to

delete. All occurrences of that note number will be deleted for the time that you continue holding down the key.

Controller data can also be erased in a similar way. For example while you move and hold the pitch bend wheel away from yourself, bend data will be erased. This applies to Pitch Bend, M.Wheel:#01, JS:CC#02, and Damper (CC#64).

Also, you can press and hold down the SEQUENCER REC (●) button to delete all MIDI data for as long as the key is held.

Multi REC [Off, On]

On (checked): Multi-track recording setup is enabled. Select this if you want to record two or more tracks simultaneously.

Use MIDI multi-track recording if you want to simultaneously record multiple MIDI tracks of different channels, such as when recording the output of the drum track, arpeggiator or step sequencer functions, or when recording the output of an external multi-track sequencer.

If this check box is selected, you'll be able to specify REC as the Play/REC/Mute status for multiple tracks. For the Play/REC/Mute (button) of the tracks that you want to record, press the ENTER button to choose R (Rec). The button indication will change in the order of P (Play) → R (Rec) → M (Mute).

Regardless of the **Track Select** (SEQ> PROG) setting, data will be recorded on the MIDI tracks that are set to REC. MIDI data will be routed to the tracks with a corresponding MIDI channel.

For details on how to record from the arpeggiator or an external multi-track sequencer onto multiple tracks of different MIDI channels, please see "Synchronizing the playback of the Arpeggiator, Drum Track function or sequencer" on page 305.

Note: If you're recording data from an external multi-track sequencer, set **MIDI Clock** (G-MIDI> BASIC) to Ext MIDI so that the KROSS will synchronize to your external sequencer. Tempo changes cannot be recorded.

Off (unchecked): Single track recording setup will be selected. Recording will occur on the track selected by **Track Select**.

Multi REC cannot be selected if **Recording Setup** is set to Loop All Tracks.

1. Create the desired Recording Setup settings.

You can record using Overwrite, Overdub, Manual Punch In, or Auto Punch In. Multi REC will be defeated if you turn LOOP on.

2. In "Recording Setup," check "Multi REC."



3. Use "Location" to specify the measure where recording will begin.

4. Press the SEQUENCER REC (●) button.

5. Select the Play/REC/Mute of the track that you want to record, and press the ENTER button to choose R.

6. Press the START/STOP (▶/■) button.

With the default settings for **Metronome Setup**, the metronome will sound for a two-measure pre-count, and then recording will begin. Now you can perform on the keyboard and controllers, and use the arpeggiator function if desired.

7. Press the START/STOP (▶/■) button.

Playback will stop, and you will return to the location specified in step 3.

Simultaneously recording MIDI data from a DAW sequencer on multiple MIDI tracks

In this example, we'll explain how to use multi-track recording to simultaneously record MIDI performance data from a DAW running on a computer that's connected to the KROSS.

1. Make sure that the USB B connector of the KROSS is connected to a USB A connector of your computer via a USB cable.
2. In the G-MIDI> BASIC page, set MIDI Clock to Ext-USB. With this setting, the KROSS will synchronize to MIDI clock messages from your external DAW.

Make sure that Receive Ext. RT Cmd (Realtime Commands) is checked.



Note: For details on how to specify the DAW as the master, see the owner's manual of your DAW.

3. Create a new song in Sequencer mode, and in the SEQ> REC page, check the Multi REC check box. Set Recording Setup to Overwrite.



4. Press Play/Rec/Mute to select "REC" for the tracks you want to record.

For the tracks you don't want to record, select Play or Mute.

5. In the SEQ> PROG page, use MIDI Channel to specify the MIDI channel of each track. Set the MIDI channel of each KROSS track to match the MIDI channel of each DAW track. Data from each channel will be recorded on the corresponding KROSS track.

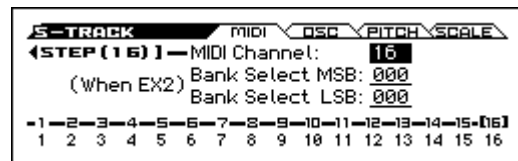

6. In the S-TRACK> MIDI page, make sure that Status is set to INT or BTH.

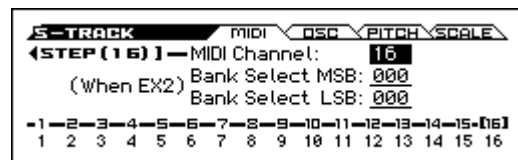

7. Press the LOCATE (◀) button to set the location to 001:01.000.
8. Press the SEQUENCER REC (●) button to enter record-standby mode.
9. Start your external sequencer.

The KROSS's sequencer will automatically begin recording when it receives the MIDI Start message transmitted by your external sequencer.

10. When playback has ended, stop your external sequencer.

The KROSS's sequencer will automatically stop recording when it receives the MIDI Stop message transmitted by the external

sequencer. You can also stop recording by pressing the START/STOP (▶/■) button on the KROSS.

After this, you can play back the newly recorded sequence:

11. In the G–MIDI> BASIC page, set MIDI Clock to Internal.

Set Tempo Mode to Auto in the SEQ> MAIN page.

Press the START/STOP (▶/■) button to play back.

Note: If the correct sounds are not selected when you start playing back, you may be able to solve the problem by using the function Event Edit (S–TRACK EDIT) to re-specify the Program Change data.

Play/Rec/Mute [Play, Rec, Mute]

Use this to mute a MIDI track, or to select the recording tracks for multi-track recording.

During playback, or for single-track recording (normal recording), you can only select Play or Mute for tracks—with the exception of the recording track. For multi-track recording, tracks can be set to Play, Rec, or Mute.

Each time you press the Play/Rec/Mute button, it will toggle between those functions.

P (Play): The track will play.

R (Rec): For single track recording, the selected track will be set to REC when you press the REC (●) button. REC cannot be manually selected.

For multi-track recording (the Preferences page **Multi REC** is on), select REC for the tracks that you wish to record.

Mute: The track will be muted (silent).

MIDI If MIDI tracks whose **Status** is BTH, EXT, or EX2 are muted by Mute or by the Solo function, note on/off messages will not be transmitted on the MIDI channel selected for those tracks.

Time Sig (Time Signature)

[**/**, 1/4...16/4, 1/8...16/8, 1/16...16/16]

This is the time signature at the current location of the song. The time signature can be changed at each measure.

****/**:** This will be displayed when you press the REC (●) button. Specify this when you wish to use the time signature that is already recorded for that measure, and wish to record without changing the time signature.

Set **Track Select** to a Track from 01–16, press the REC (●) button, and specify the time signature here.

When you press the START/STOP (▶/■) button to begin recording, the time signature that you specify will be recorded on the tempo track and on previously recorded tracks.

Be aware that if you press the START/STOP (▶/■) button during the pre-count to stop recording, the time signature will not be recorded.

Normally, you will specify the time signature when you record the first track, and select ****/**** when recording subsequent tracks.

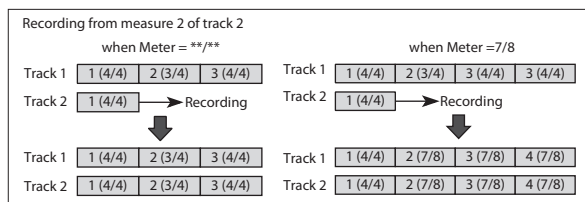

Changing the time signature in the middle of a song

If you know the location where you wish to change time signatures, use the **Insert Measure** function to specify and insert the time signature wherever desired, and then record your musical data.

If you want to change the time signature of a song that already contains performance data, use the Event Edit function to edit the time signature of a bar event.

If the number of beats in a measure increases when you modify the time signature, rests will be inserted in the portion that was added. Conversely if the number of beats decreases, that portion will not be played. However if you return to the original time signature, the data that had been hidden will once again be played. (The data itself will not be erased.)

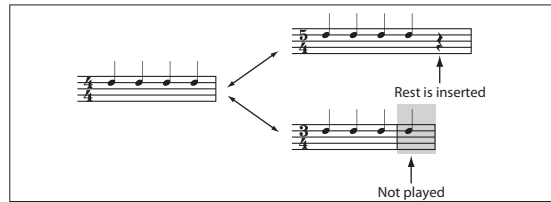

Tempo Mode [Auto, Manual, REC]
(Tempo) [040.00...300.00, EXT]

This specifies the tempo of the song.

METRONOME

Setup

Here you can adjust metronome settings. Press the ENTER button to access the METRONOME SETUP dialog box.

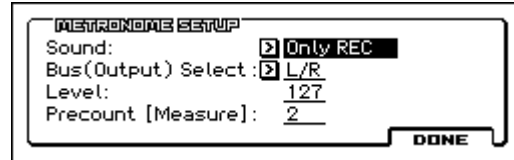

Sound [Only REC, REC & Play, Off]

Only REC: The metronome will sound only during recording.

REC & Play: The metronome will sound during recording and playback.

Off: The metronome will not sound during playback or recording. However, the pre-count metronome will sound before recording begins.

Bus (Output) Select [L/R, L, R]

Selects the output destination of the metronome sound.

L/R: Output from AUDIO OUTPUT L/Mono and R.

L: Output from AUDIO OUTPUT L/Mono.

R: Output from AUDIO OUTPUT R.

Level [000...127]

Sets the volume of the metronome.

Precount [Measure] [0...2]

Specifies the pre-count that will occur before recording begins.

With a setting of 0, recording will begin the instant you press the START/STOP (▶/■) button (after first pressing the REC (●) button).

0-5: ARP (Arpeggiator)

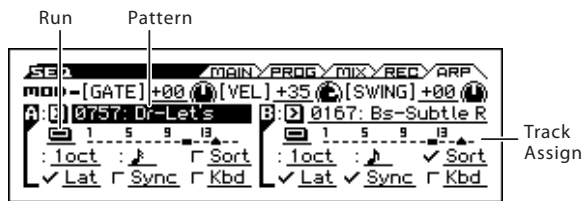

Here you can adjust arpeggiator settings for the song. A song can run two arpeggiators simultaneously.

Arpeggiator parameters can be edited in S-ARP, but certain major parameters can be edited in these pages as well.

You can also control the arpeggiator in real time by using the TEMPO knob or [GATE], [VELOCITY], and [SWING].

MOD (Modulation)

[GATE] [-64...+00...+63]

Specifies the length (gate time) of each note in the arpeggio. (see page 51)

[VEL] (Velocity) [-64...+00...+63]

Specifies the velocity of the notes in the arpeggio. (see page 51)

[SWING] [-64...+00...+63]

This parameter shifts the timing of the odd-numbered notes of the arpeggio. (see page 52)

A, B (Arpeggiator A, B)

Arpeggiator Run A, B [Off, On]

When the ARP button is on, the arpeggiator(s) you checked here will run if they are assigned to a timbre by **Arpeggiator Assign** (S-ARP> ASSIGN.)

When the arpeggiator is on, these check boxes let you turn A and B on/off.

This parameter can also be set from S-ARP page **Arpeggiator Run A, B**.

Track assign

This indicates the arpeggiator A and B assignment status for each track 1-8. These settings are made in **Arpeggiator Assign** (S-ARP>ASSIGN).

Pat (Pattern) [Preset: UP...RANDOM, 0000...1027]

Octave [1oct, 2oct, 3oct, 4oct]

Resolution [♩, ♪, ♫, ♮, ♯, ♭, ♭♭, ♯♯]

Sort [Off, On]

Lat (Latch) [Off, On]

Sync (Key Sync.) [Off, On]

Kbd (Keyboard) [Off, On]

Set the various parameters of the combination arpeggiator.

These parameters can also be set from S-ARP pages.

For more information, please see the “7: S-ARP (Arpeggiator)” section on page 125.

0-1...5: FUNCTION

- 0: **Memory Status** see page 137
- 1: **Solo Setting** see page 63
- 2: **Undo** see page 137
- 3: **Create New Song** see page 137
- 4: **Rename Song** see page 137
- 5: **Delete Song** see page 137
- 6: **Copy From Song** see page 137
- 7: **Copy from Combination** see page 138
- 8: **Copy from Program** see page 139
- 9: **Load Template Song** see page 139
- 10: **Save Template Song (Save as User Template Song)** see page 140
- 11: **GM Initialize** see page 141
- 12: **FF/REW Speed** see page 142
- 13: **Set Location (Set Location for Locate Key)** see page 142
- 14: **Copy Arpeggiator** see page 150

For more information, please see the “Sequencer: FUNCTION” section on page 137.

1: S-INPUT/CTRL (Input/Controllers)

1-1: AUDIO IN

About the AUDIO IN button

Settings on this page are active when the front panel AUDIO IN button is on, allowing an external audio signal to be input.

 The sequencer does not have tracks for recording audio.



Input Level Meter

G-SET (Use Global Setting)	[Off, On]
Pan	[L000...L063, C064, R065...R127]
Select	[Line, Mic]
Input Level Meter	
Level	[000...127]
Mute/Play	[Mute, Play]
Gain	[00...82, MAX]
Bus (Bus Select)	[L/R, IFX1...5, Off]
Send1	[000...127]
Send2	[000...127]
FX Control Bus	[Off, FC1, FC2]

These settings are the same as in Program or Global mode.

See “1-1: AUDIO IN” on page 5

1-2: CONTROLLERS

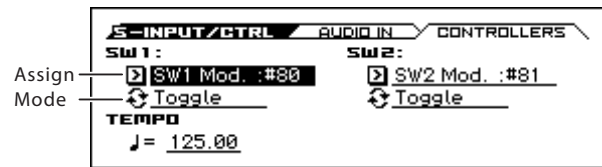

Here you can assign the functions performed by SW1 and SW2.

When you use these buttons during recording, MIDI messages will be recorded.

Note: The Panel Switch Assign setting of the program assigned to each track will have no effect.

SW1

Assign [Off, ..., Pitch Bend Lock]

This assigns the function of SW1. For more information, please see the “SW1, SW2 Assign List” section on page 290.

Note: If you change the function setting, the status is reset to off.

Note: If the on/off status of the SW1, SW2 switches is memorized when you save it.

Mode [Toggle, Momentary]

This specifies the on/off operation when you press the SW1 switch.

Toggle: The function will alternate between on and off each time you press the SW1 switch.

Momentary: The function will be on only while you continue holding down the SW1 switch.

SW2

SW2 (SW2 Assign) [Off, ..., Pitch Bend Lock]

Mode (SW2 Mode) [Toggle, Momentary]

This assigns the function of SW2. The functions that can be assigned to SW2 are the same as for SW1, with the substitution of SW2 Mod. (CC#81) instead of the SW1’s SW1 Mod. (CC#80).

Tempo

J (Tempo) [040.00...300.00, EXT]

This specifies the tempo of the song. This tempo applies to song playback, arpeggiator, drum track, step sequencer, tempo-synced LFOs, and tempo-synced effects.

See “J (Tempo)” on page 103

✓ 1-1, 2: FUNCTION

- 0: **Memory Status** see page 137
- 1: **Solo Setting** see page 63
- 2: **Undo** see page 137
- 3: **Create New Song** see page 137
- 4: **Rename Song** see page 137
- 5: **Delete Song** see page 137
- 6: **Copy From Song** see page 137
- 7: **Copy from Combination** see page 138
- 8: **Copy from Program** see page 139
- 9: **Load Template Song** see page 139
- 10: **Save Template Song (Save as User Template Song)** see page 140
- 11: **GM Initialize** see page 141
- 12: **FF/REW Speed** see page 142
- 13: **Set Location (Set Location for Locate Key)** see page 142

For more information, please see the “Sequencer: FUNCTION” section on page 137.

2: S-LOOP/TONE

2-1: LOOP (Track Play Loop)



When playing or recording a song, you can independently loop the MIDI tracks.

Track 01...16 (Track Number)

To select a track, place the cursor at one of the following parameters, and use the cursor buttons ◀▶ to switch tracks. (see page 105)

Track Play Loop [Off, On]

Specifies looping for a MIDI track.

On (checked): That track will loop between **Loop Start Measure** and **Loop End Measure**.

Play Intro [Off, On]

On (checked): After the measures before the specified **Loop Start Measure** are played once, the region of **Loop Start Measure** – **Loop End Measure** will be played repeatedly.

For example, you can use this on a drum track to make it play a fill-in and then begin looping.

Off (unchecked): Playback will begin from the **Loop Start Measure**, and will begin looping immediately.

This will be valid if **Track Play Loop** is checked and **Loop Start Measure** is set to other than 001.

Loop Start Measure [001...999]

Specifies the first measure of the loop.

Loop End Measure [001...999]

Specifies the last measure of the loop.

Example)

When “Play Intro” is checked

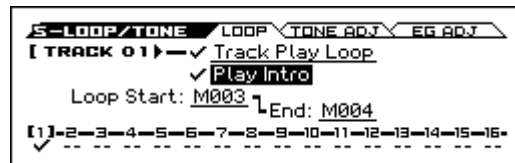

Track 1 will loop as follows.

M001 – M002 – M003 – M004 – M003 – M004 – M003 – M004...

When “Play Intro” is not checked

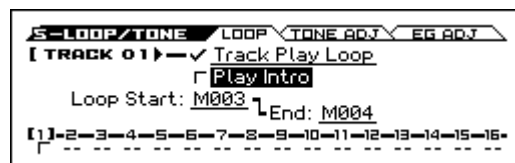

Track 1 will loop as follows.

M003 – M004 – M003 – M004 – M003 – M004 – M003 – M004...

In this way, you can use **Track Play Loop** to make the realtime recording process more efficient.

Track Info.

Shows the settings of tracks 1–16 for the parameter that you're editing.

Note: If this is disabled because of the setting of another parameter, “–” is shown.

2–2: TONE ADJ (Tone Adjust)

The Tone Adjust function and EG Adjust function let you make simple changes to the sound by adjusting the main program parameters for each track's program, such as the filter or the filter and amp EG.

The result of editing the Tone Adjust and EG Adjust parameters is saved in the song.

This lets you adjust the sound of each timbre without modifying the original program sounds. For example, it's easy to brighten the sound of a track by raising its cutoff frequency so that it will fit better with the other sounds of the song.

Tone/EG Adjust settings and MIDI control changes

Many of the program parameters that are affected by Tone Adjust can also be modified via MIDI CC.

Adjustments via Tone Adjust and changes via MIDI CC are always enabled; these two are combined to determine the actual change that is applied.

The MIDI control change numbers (CC#) corresponding to each Tone Adjust parameter are shown below.

- Cutoff: CC#74
 - Resonance: CC#71
 - EG Intensity: CC#79
 - Vel. Intensity: Not supported
 - Attack: CC#75
 - Decay: CC#75
 - Sustain: CC#70
 - Release: CC#72
- See page 297, 303

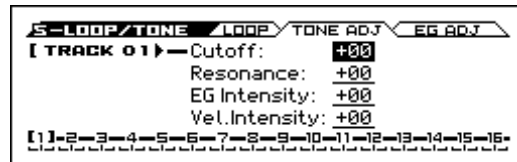

Most of these functions adjust (scale) the parameter settings of the timbre programs. Unless otherwise noted, “scaling” means that the parameters are at their programmed values when the controller is at 64, at their minimum when the controller is at -99, and at their maximum when the controller is at +99. For another look at this, please see the diagram below.

CC scaling of parameters

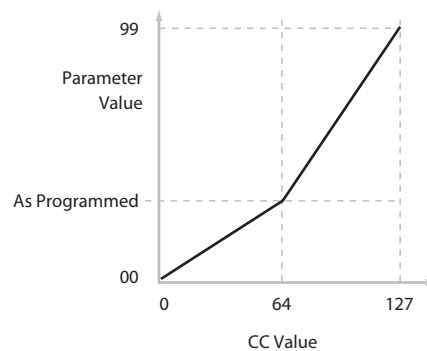

Track 01...16 (Track Number)

To select a track, place the cursor at one of the following parameters, and use the cursor buttons ◀▶ to switch tracks. (see page 105)

Cutoff (Filter Cutoff) [-99...+99]

Adjusts the cutoff frequency of filters A and B.

Resonance (Filter Resonance) [-99...+99]

Adjusts the resonance of filters A and B.

EG Intensity (Filter EG Intensity) [-99...+99]

Adjusts the effect of the filter EG on the cutoff frequency of filters A and B.

Vel. Intensity (Amp Velocity Intensity) [-99...+99]

Adjusts the velocity intensity for the amp level.

Track Info.

Shows the settings of tracks 1–16 for the parameter that you're editing.

If this is disabled because of the setting of another parameter, “_” is shown.

2-3: EG ADJ (EG Adjust)**Track 01...16 (Track Number)**

To select a track, place the cursor at one of the following parameters, and use the cursor buttons ◀▶ to switch tracks. (see page 105)

Attack (Filter/Amp EG Attack Time) [-99...+99]

This scales the attack times of the Filter and Amp EGs, along with other related parameters.

When the value is +1 or more, this also affects the Amp EG's Start and Attack Levels, Start Level AMS, and Attack Time AMS.

Between values of +1 and +25, the Start Level, Start Level AMS, and Attack Time AMS will change from their programmed values to 0. Over the same range, the Attack Level will change from its programmed value to 99.

Decay (Filter/Amp EG Decay Time) [-99...+99]

This scales the decay and slope times of the Filter and Amp EGs.

Sustain (Filter/Amp EG Sustain Level) [-99...+99]

This scales the sustain levels of the Filter and Amp EGs.

Release (Filter/Amp EG Release Time) [-99...+99]

This scales the release times of the Filter and Amp EGs.

Track Info.

Shows the settings of tracks 1–16 for the parameter that you're editing.

2-1...3: FUNCTION

- 0: **Memory Status** see page 137
- 1: **Solo Setting** see page 63
- 2: **Undo** see page 137
- 3: **Create New Song** see page 137
- 4: **Rename Song** see page 137
- 5: **Delete Song** see page 137
- 6: **Copy From Song** see page 137
- 7: **Copy from Combination** see page 138
- 8: **Copy from Program** see page 139
- 9: **Load Template Song** see page 139
- 10: **Save Template Song (Save as User Template Song)** see page 140
- 11: **GM Initialize** see page 141
- 12: **FF/REW Speed** see page 142
- 13: **Set Location (Set Location for Locate Key)** see page 142

For more information, please see the “Sequencer: FUNCTION” section on page 137.

3: S-TRACK (Track Parameters)

3-1: MIDI

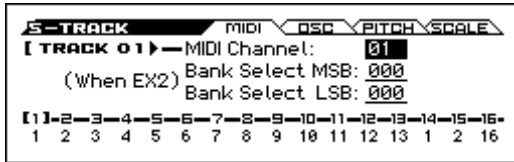

Here you can adjust MIDI-related settings for each MIDI track.

Track 01...16 (Track Number)

To select a track, place the cursor at one of the following parameters, and use the cursor buttons ◀ ▶ to switch tracks. (see page 105)

MIDI Channel [01...16]

Specifies the MIDI channel that the MIDI track will use to transmit and receive musical data. The MIDI channel you specify here will be the receive channel when **Status** is INT, the transmit channel when it is EXT or EX2, and the receive/transmit channel when it is BTH. Tracks set to INT which have the same MIDI channel will sound and be controlled identically when they receive MIDI data or data from the sequencer tracks.

Bank Select MSB (When Status=EX2) [000...127]

Bank Select LSB (When Status=EX2) [000...127]

When **Status** is set to EX2, this sets the bank number that will be transmitted. When **Status** is other than EX2, this setting has no effect.

Track Info.

Shows the settings of tracks 1–16 for the parameter that you're editing.

If this is disabled because of the setting of another parameter, “–” is shown.

3-2: OSC



These parameters specify how each MIDI track will be sounded.

Track 01...16 (Track Number)

To select a track, place the cursor at one of the following parameters, and use the cursor buttons ◀ ▶ to switch tracks. (see page 105)

Force OSC Mode [PRG, Poly, Mono, Legato]

This lets you override the Program's stored Voice Assign Mode settings, if desired.

PRG: The Program's stored P-BASIC> VOICE Voice Assign Mode settings will be used.

Poly: The track will play polyphonically, regardless of the Program's settings.

Mono: The track will play monophonically, regardless of the Program's settings.

Legato: The track program will sound monophonically, and will play legato according to the Program's **Mode** setting (P-BASIC> VOICE).

With the MN or LGT settings, the Program's **Priority** setting (P-BASIC> VOICE) will determine the priority of the note that sounds when you play two or more notes.

OSC Select [OSC1 & 2, only OSC1, only OSC2]

Specifies whether the MIDI track's program will play OSC1, OSC2, or both.

For programs whose **OSC**(P-BASIC> VOICE) is Double, this setting lets you specify that only OSC1 or OSC2 will sound.

OSC1 & 2: OSC1 and 2 will sound as specified by the settings of the program.

only OSC1: Only OSC1 will sound.

only OSC2: Only OSC2 will sound. PCM programs will not sound if **Oscillator Mode** is set to Single or Drums.

Portamento [PRG, Off, 001...127]

Create portamento settings for each MIDI track.

The portamento setting you make here will be used when the song is played or recorded from the beginning. If you change the setting while recording, it will be recorded as part of the musical data. (However if you set this to PRG, it will not be recorded.) You can change this setting during playback. However if you play back any Portamento On/Off data or Portamento Time data that was previously recorded, the settings will change accordingly.

When the track where the **Status** (SEQ> PROG) is INT or BTH, MIDI control change CC#05 (Portamento Time) and CC#65 (Portamento Switch) can be received to control this and change the setting. (If the setting is PRG, CC#05 Portamento Time will not be received.)

When you switch songs or return to the beginning of the song, tracks where the **Status** is BTH, EXT, or EX2 will transmit this setting via MIDI. If this is Off, CC#65 with a value of 0 will be transmitted. If this is 001–127, a CC#65 of 127 and CC#05 of 1–127 will be transmitted.

If this is set to PRG, nothing will be transmitted.

This data is transmitted and received on the MIDI channel specified for each track by **MIDI Channel** (S-TRACK> MIDI). (See G-MIDI> OUT: SEQ Mode “Track MIDI Out” on page 161)

Track Info.

Shows the settings of tracks 1–16 for the parameter that you're editing.

Note: If this is disabled because of the setting of another parameter, “–” is shown.

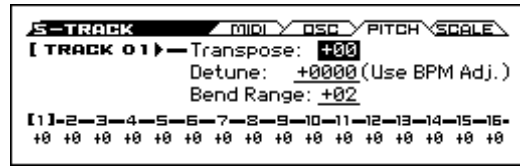
3-3: PITCH

Here you can make pitch-related settings for each MIDI track.

Track 01...16 (Track Number)

To select a track, place the cursor at one of the following parameters, and use the cursor buttons ◀ ▶ to switch tracks. (see page 105)

Transpose [–60...+00...+60]

Adjusts the pitch of each MIDI track in semitone steps.
12 units equal one octave.

Detune (Use BPM Adj.) [–1200...+0000...+1200]

Adjusts the pitch of each MIDI track in one-cent units.
+0000: Normal pitch.

Note: You can also use the **Detune BPM Adjust** function (see page 96) to automatically make a detune setting from a calculation in BPM units.

MIDI **Transpose** and **Detune** do not affect the notes transmitted via MIDI Out. **Transpose** and **Detune** can be controlled via MIDI RPN messages received on the Track's MIDI channel. The way that this works depends on whether or not the Track uses a Drum Program.

If the Track does not use a Drum Program for example, if it uses a Single or Double Program then MIDI RPN Coarse Tune will control **Transpose**, and RPN Fine Tune will control **Detune**.

If the Track uses a Drum Program, MIDI RPN Coarse Tune and Fine Tune will be combined to control **Detune**. The overall range is ±1 octave for coarse tune and fine tune together.

Bend Range [PRG, –24...+00...+24]

Specifies the amount of pitch change that will occur when the pitch bender is used, in semitone units.

PRG: The pitch range specified by the program will be used.

–24...+24: This setting will be used regardless of the setting in the program.

MIDI As long as this is set to something other than PRG, you can control the **Bend Range** using MIDI RPN Pitch Bend Change messages.

Track Info.

Shows the settings of tracks 1–16 for the parameter that you're editing.

If this is disabled because of the setting of another parameter, “–” is shown.

3-4: SCALE

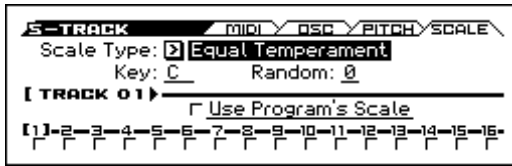

Here you can adjust the settings for the scale for each MIDI track.

Scale Type (Song's Scale) [Equal Temperament...User Octave Scale15]

Selects the scale.

Key [C...B]

Random [0...7]

As this value is increased, an increasingly random deviation will be added to the pitch at each note-on.

MIDI If **Status** (SEQ> PROG) is INT, this setting will affect the pitch produced by the KROSS. If **Status** is EXT, this setting will affect the note number of the note messages transmitted via MIDI.

Track 01...16 (Track Number)

To select a track, place the cursor at one of the following parameters, and use the cursor buttons ◀ ▶ to switch tracks. (see page 105)

Use Program's Scale [Off, On]

MIDI tracks can use the scale that is specified by **Scale** (P-BASIC> SCALE).

On (checked): The scale specified by the program will be used.

Off (unchecked): The scale specified by **Scale** will be used.

Track Info.

Shows the settings of tracks 1-16 for the parameter that you're editing.

If this is disabled because of the setting of another parameter, “_” is shown.

3-1...4: FUNCTION

- 0: **Memory Status** see page 137
- 1: **Solo Setting** see page 63
- 2: **Undo** see page 137
- 3: **Create New Song** see page 137
- 4: **Rename Song** see page 137
- 5: **Delete Song** see page 137
- 6: **Copy From Song** see page 137
- 7: **Copy from Combination** see page 138
- 8: **Copy from Program** see page 139
- 9: **Load Template Song** see page 139
- 10: **Save Template Song (Save as User Template Song)** see page 140
- 11: **GM Initialize** see page 141
- 12: **FF/REW Speed** see page 142
- 13: **Detune BPM Adjust** see page 142
- 14: **Set Location (Set Location for Locate Key)** see page 142

For more information, please see the “Sequencer: FUNCTION” section on page 137.

4: S-ZONE /DELAY (Zones/Delay)

4-1: KEY ZONE (Keyboard Zones)

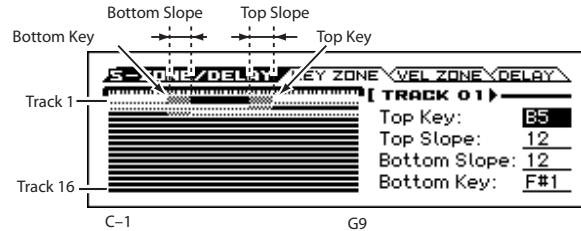

Here you can specify the key zones where MIDI tracks 1-16 will sound.

The top/bottom key settings specify the zone where MIDI tracks 1-16 will sound, and the top/bottom slope settings specify the key range where the volume will change starting from the top/bottom key.

For more information, please see the “4-1: KEY ZONE (Keyboard Zones)” section on page 118.

MIDI These settings do not affect MIDI transmission/reception. All note data that is received will be recorded into the internal sequencer, and all note data from the internal sequencer or from the keyboard will be transmitted.

Zone Map

This area indicates the note and velocity ranges where each MIDI track (1-16) will sound.

A line indicates the range of notes that will sound, and the slope within that range is shaded.

Track 01...16 (Track Number)

To select a track, place the cursor at one of the following parameters, and use the cursor buttons ◀ ▶ to switch tracks. (see page 105)

Top Key [C-1...G9]

Specifies the top key (upper limit) of the notes that will sound for each MIDI track.

Top Slope [00, 01, 02, 03, 04, 06, 08, 10, 12, 18, 24, 30, 36, 48, 60, 72]

Specifies the range of keys (12 is one octave) where the volume will be reached starting from the top key.

0: The volume will be at the original level from the top key.

12: The volume will increase gradually as you play downward, and will reach the original volume one octave below the top key.

72: The volume will increase gradually as you play downward, and will reach the original volume six octaves below the top key.

Bottom Slope [00, 01, 02, 03, 04, 06, 08, 10, 12, 18, 24, 30, 36, 48, 60, 72]

Specifies the range of keys (12 is one octave) where the volume will be reached starting from the bottom key.

0: The volume will be at the original level from the bottom key.

12: The volume will increase gradually as you play upward, and will reach the original volume one octave above the bottom key.

72: The volume will increase gradually as you play upward, and will reach the original volume six octaves above the bottom key.

Bottom Key [C-1...G9]

Specifies the bottom key (lower limit) of the notes that will sound for each MIDI track.

How volume will change according to keyboard location

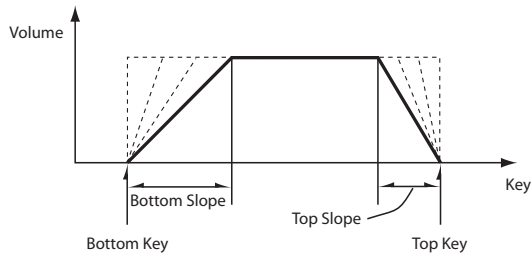

Tip: You can also set the note values and velocity values by the keyboard (see page 12 of the Operation Guide).

 It is not possible to set the bottom key above the top key of the same track. Nor is it possible for the top and bottom slopes to overlap.

4-2: VEL ZONE (Velocity Zones)

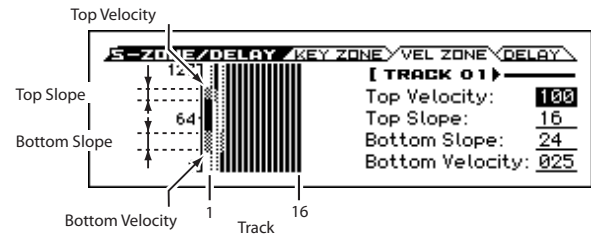

Here you can set the Top/Bottom Velocity parameters to specify the range of velocities that will be sounded by MIDI tracks 1–16, and Top/Bottom Slope specifies the range where the volume will be adjusted.

For more information, please see the “4-2: VEL ZONE (Velocity Zones)” section on page 119.

 These settings do not affect MIDI transmission/ reception. All note data that is received will be recorded into the internal sequencer, and all note data from the internal sequencer or from the keyboard will be transmitted.

 It is not possible to set the bottom velocity greater than the top velocity for the same track. Nor can the top slope and the bottom slope overlap.

Zone Map

This area indicates the note and velocity ranges where each MIDI track will sound.

A line indicates the range of velocity that will sound, and the slope within that range is shaded.

Track 01...16 (Track Number)

To select a track, place the cursor at one of the following parameters, and use the cursor buttons ◀▶ to switch tracks. (see page 105)

Top Velocity [1...127]
Specifies the maximum velocity value that will sound each track.

Top Slope [0...120]
Specifies the number of velocity steps where the original volume will be reached, starting from the Top Velocity.

0: The volume will be at the original value from the top velocity.

120: The volume will decrease as the velocity approaches the top velocity.

Bottom Slope [0...120]
Specifies the number of velocity steps where the original volume will be reached, starting from the Bottom Velocity.

0: The volume will be at the original value from the bottom velocity.

120: The volume will decrease as the velocity approaches the bottom velocity.

Bottom Velocity [1...127]
Specifies the minimum velocity that will be sounded by each MIDI track 1–16.

How volume will change according to keyboard location

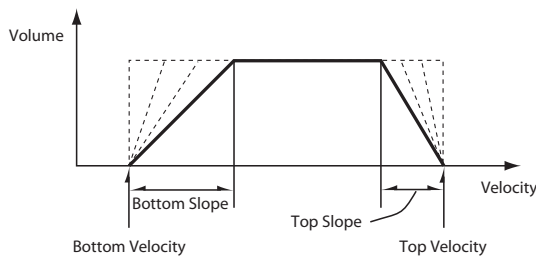

Note: You can also set the note values and velocity values by keyboard (see page 12 of the Operation Guide).

4-3: DELAY

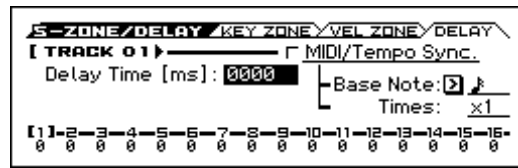

This specifies the time (delay) from when the MIDI tracks 1–16 receive a note-on message until the sound begins.

Track 01...16 (Track Number)

To select a track, place the cursor at one of the following parameters, and use the cursor buttons ◀ ▶ to switch tracks. (see page 105)

Delay Time [ms] [0000...5000ms, KeyOff]

Specifies the time (delay time) from note-on until the MIDI track begins to produce sound, in units of ms (1/1000th of a second). This setting is available if **MIDI/Tempo Sync.** is set to Off.

KeyOff: The note will begin sounding at note-off. In this case, the sound will not die away if the sustain level of the program's amp EG is other than 0. This setting is used when creating harpsichord sounds.

Normally you will set this to 0000.

MIDI/Tempo Sync. [Off, On]

The time (delay time) from note-on until the track produces sound will be specified in note length units relative to the ♩ (**Tempo**).

On (checked): Specify the delay time in terms of a **Base Note** and **Times** relative to the **Tempo**. For example if **Base Note** = ♩, **Times** = 01, and **Tempo** = 60 BPM, the delay time will be equivalent to 1000 ms.

Off (unchecked): The delay time will be set by the **Delay Time** setting.

Base Note [♪, ♪, ♫, ♮, ♯, ♭, ♮, ♯, ♭, ♮, ♯, ♭, ♮, ♯, ♭, ♮]

Times [01...32]

It specifies the time (delay time) from note-on until the track begins to produce sound, in terms of a note value relative to the ♩ (**Tempo**) (SEQ> MAIN).

Use **Base Note** to specify the desired note value, and use **Times** to extend that note value by the specified multiple.

For example if you set **Base Note** to a quarter note (♪) and **Times** to 02, that track will sound with a delay of a half note (♪). Even if you change ♩ (**Tempo**), the delay time will always be a half note (♪). If you use these parameters to specify a delay of a half note (♪). In this case, a **Tempo** of 60.00 BPM will produce a 2000 ms delay, and a **Tempo** of 120.00 BPM will produce a 1000 ms delay.

Track Info.

Shows the settings of tracks 1–16 for the parameter that you're editing.

If this is disabled because of the setting of another parameter, “-” is shown.

✓ 4-1...3: FUNCTION

- 0: **Memory Status** see page 137
 - 1: **Solo Setting** see page 63
 - 2: **Undo** see page 137
 - 3: **Create New Song** see page 137
 - 4: **Rename Song** see page 137
 - 5: **Delete Song** see page 137
 - 6: **Copy From Song** see page 137
 - 7: **Copy from Combination** see page 138
 - 8: **Copy from Program** see page 139
 - 9: **Load Template Song** see page 139
 - 10: **Save Template Song (Save as User Template Song)** see page 140
 - 11: **GM Initialize** see page 141
 - 12: **FF/REW Speed** see page 142
 - 13: **Set Location (Set Location for Locate Key)** see page 142
- For more information, please see the “Sequencer: FUNCTION” section on page 137.

5: S– MIDI FILTER

Here you can select whether or not to apply filtering to the MIDI data received by MIDI tracks 1–16. For example even if two tracks are receiving the same MIDI channel, one can be set to respond to damper pedal activity while the other does not.

MIDI These MIDI filter settings have no effect on the MIDI messages that have already been recorded.

MIDI These settings affect the MIDI messages that are transmitted when you adjust program, pan, volume, portamento and send 1/2 parameters of a track whose **Status** (SEQ> PROGc) is set to BTH, EXT, or EX2.

On (checked): Reception of MIDI data is enabled. Tracks where the **Status** (SEQ> PROG) is INT or BTH will receive these types of MIDI messages on their respective channels. The type of effects that are checked will be applied to the program of each track when the KROSS’s controllers are used or when MIDI data is received. (The effect dynamic modulation function is not affected by these settings.)

Settings that regulate MIDI transmission/reception of the KROSS itself are created in the MIDI Filter (G–MIDI> FILTER).

If the user-assignable controllers that can be filtered in the MIDI Filter 3 pages are set to MIDI control changes, filtering will be performed for these control changes. In this case, any control change filtering that is being performed in the MIDI Filter 1 to 2 pages will be given priority. Furthermore, if the same control change is assigned to multiple controllers where there are filter settings in the MIDI Filter 4 pages, checking any one of these will enable that control change.

Off (unchecked): Reception of MIDI data is disabled.

Note: MIDI CC# = MIDI control change message numbers.

Track 01...16 (Track Number)

To select a track, place the cursor at one of the following parameters, and use the cursor buttons ◀ ▶ to switch tracks. (see page 105)

Track Info.

Shows the settings of tracks 1–16 for the parameter that you're editing.

If this is disabled because of the setting of another parameter, “–” is shown.

5–1: 1 (MIDI Filter1)

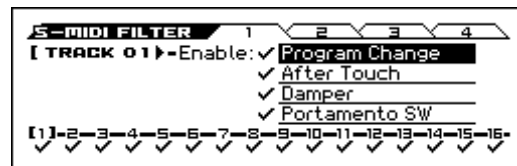

Enable Program Change

[Off, On]

Specifies whether or not MIDI program change messages will be received.

Enable After Touch

[Off, On]

Specifies whether or not MIDI after touch messages will be received.

Enable Damper

[Off, On]

Specifies whether or not MIDI CC#64 hold (damper pedal) messages will be received.

Enable Portamento SW

[Off, On]

Specifies whether or not MIDI CC#65 portamento on/off messages will be received.

5–2: 2 (MIDI Filter2)

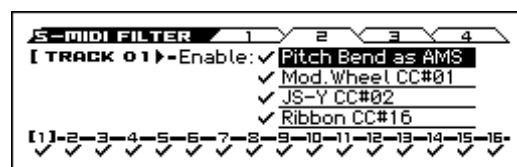

Enable Pitch Bend as AMS

[Off, On]

Specifies whether or not MIDI pitch bend messages (usage of the pitch bend wheel) will be received to control the AMS effect assigned to Pitch Bend. (This is not a filter for MIDI pitch bend message reception.) For more information, please see the “Alternate Modulation Sources (AMS)” section on page 281.

Enable Mod. Wheel CC#01

[Off, On]

Specifies whether or not MIDI CC#1 (the usage of the modulation wheel) will be received.

Enable JS–Y CC#02

[Off, On]

Specifies whether or not MIDI CC#2 will be received.

Enable Ribbon CC#16

[Off, On]

Specifies whether or not MIDI CC#16 will be transmitted or received.

5-3: 3 (MIDI Filter3)

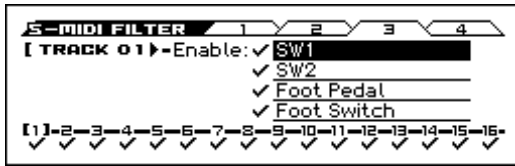

Enable SW1 [Off, On]

Enable SW2 [Off, On]

These settings specify whether SW1 Mod (CC#80) and SW2 Mod (CC#81) will be transmitted and received if they are assigned to the SW1 and SW2 buttons.

Note: If Portamento SW (CC#65) is assigned to SW1 or SW2, the Enable Portamento SW setting on the 1 page will take priority.

Note: The functions of SW1 and SW2 are assigned on the P1: Controllers Setup page (see page 112).

Enable Foot Switch [Off, On]

Specifies whether or not the effect of the ASSIGNABLE SWITCH will be received when a MIDI control change is assigned. The function is assigned in G-INPUT/CTRL> FOOT page.

Enable Foot Pedal [Off, On]

Specifies whether or not the effect of the ASSIGNABLE PEDAL will be received when a MIDI control change is assigned. The function is assigned in G-INPUT/CTRL> FOOT page.

5-4: 4 (MIDI Filter4)

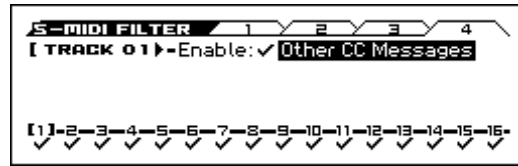

Enable Other CC Messages [Off, On]

Specifies whether or not MIDI control messages not covered in the preceding MIDI Filter items will be received.

✓ 5-1...4: FUNCTION

- 0: **Memory Status** see page 137
- 1: **Solo Setting** see page 63
- 2: **Undo** see page 137
- 3: **Create New Song** see page 137
- 4: **Rename Song** see page 137
- 5: **Delete Song** see page 137
- 6: **Copy From Song** see page 137
- 7: **Copy from Combination** see page 138
- 8: **Copy from Program** see page 139
- 9: **Load Template Song** see page 139
- 10: **Save Template Song (Save as User Template Song)** see page 140
- 11: **GM Initialize** see page 141
- 12: **FF/REW Speed** see page 142
- 13: **Set Location (Set Location for Locate Key)** see page 142

For more information, please see the “Sequencer: FUNCTION” section on page 137.

6: S–TRACK EDIT (Track Edit)

6–1: SELECT MEASURE TO EDIT

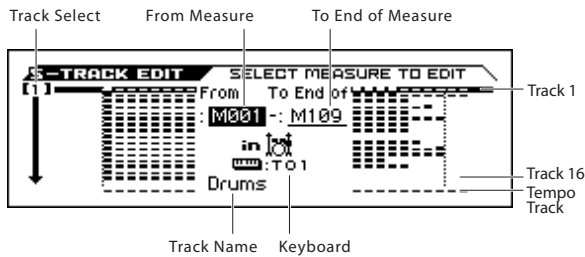

Here you can edit MIDI tracks 1–16, and the tempo track.

When editing a MIDI track, you can move, insert, and delete individual note events or control change data, or copy, move, insert, and delete measures or tracks.

Note: To perform track editing (or step editing), use **Track Select** to select the track you want to edit, and use **From Measure** and **To End of Measure** parameters to specify the region that you want to edit. Then choose a command from the menu, and execute the edit. For details on the specific commands, please see “Sequencer: FUNCTION” on page 137.

Track Select [01...16]

Select the MIDI track that you want to record.

Track01...Track16: Select the track that you want to record or edit. Use the cursor buttons ◀ ▶ to make the selection.

Track Data Map

This area shows the presence or absence of performance data, and indicates the edit range, etc. The currently selected Track will be highlighted.

From Measure [001...999]

To End of Measure [001...999]

Specifies the range of measures that you wish to edit (or copy from).

Use **From Measure** to specify the starting measure, and **To End of Measure** to specify the ending measure.

in [Track Info(Category Icon,Tools Icon)/Keyboard/Track Name]

Shows the category icon and name of the selected track.

Keyboard

This shows the number of the track that will sound when you play the keyboard.

Track Name

To specify the track name, use the Rename Track function.

6–1: FUNCTION

- 0: **Memory Status** see page 137
- 1: **Solo Setting** see page 63
- 2: **Undo** see page 137
- 3: **Link From Measure current location** see page 142
- 4: **Set Location (Set Location for Locate Key)** see page 142
- 5: **Erase Track** see page 142
- 6: **Copy/Bounce Track** see page 143
- 7: **Erase Measure** see page 143
- 8: **Delete Measure** see page 144
- 9: **Insert Measure** see page 144
- 10: **Repeat Measure** see page 145
- 11: **Copy Measure** see page 145
- 12: **Move Measure** see page 146
- 13: **Create/Erase Control Data** see page 147
- 14: **Quantize** see page 148
- 15: **Shift/Erase Note** see page 149
- 16: **Modify Velocity** see page 149
- 17: **Event Edit** see page 150
- 18: **Rename Track** see page 150

For more information, please see the “Sequencer: FUNCTION” section on page 137.

7: S-ARP (Arpeggiator)

Here you can specify how the arpeggiator will function in Sequencer mode. These settings can be adjusted for each song. In Sequencer mode (as in Combination mode), you can run the two arpeggiators simultaneously.

This allows you to apply different arpeggio patterns to two sounds that have been split across the keyboard, or use velocity to switch between two different arpeggio patterns, etc.

In Sequencer mode, the musical data generated by the arpeggiator during song track realtime-recording can be recorded.



It is not possible to set independent tempos for the arpeggiator and the sequencer.

When **MIDI Clock** (G-MIDI>BASIC) is set to **Internal**, the arpeggiator can be synchronized to the internal sequencer.

- When you turn on the arpeggiator and press the START/STOP (▶/■) button, the arpeggiator will synchronize with the sequencer.
- When you press the START/STOP (▶/■) button, the arpeggiator and sequencer will both stop. If you wish to stop only the arpeggiator, press the ARP button to turn it off.

When the arpeggiator **Key Sync** is off, you can turn on the ARP button and play the keyboard to start the arpeggiator during the pre-count before realtime recording begins. That way, the arpeggiator performance will be recorded from the beginning of the pattern when recording starts.



When **MIDI Clock** is set to External MIDI or External USB, clock messages transmitted from an external MIDI device can perform the same type of control.

Even in this case, you can start/stop using the KROSS's START/STOP (▶/■) button.

7-1: ASSIGN



Track 01...16 (Track Number)

To select a track, place the cursor at one of the following parameters, and use the cursor buttons ◀▶ to switch tracks. (see page 105)

ARP Assign

[Off, A, B]

This individually assigns arpeggiator A or arpeggiator B to each track 1-16. When the ARP button is turned on, the arpeggiator specified for each track will run, subject to the **Arpeggiator Run A, B** settings and the settings made here.

Off: Neither arpeggiator will run.

A: Enables Arpeggiator A. Use the Arpeggiator A page to select the arpeggio pattern and set the parameters.

B: Enables Arpeggiator B. Use the Arpeggiator B page to select the arpeggio pattern and set the parameters.

For tracks that you wish to record in real time, select either arpeggiator A or B. If you specify an arpeggiator for two or more tracks, the arpeggiator will play each of the tracks you specify.

You can set A and B to two different MIDI channels, and control one from the keyboard and the other from an external MIDI device connected to MIDI IN. You can also use multi-track recording (Multi REC) to simultaneously record the note data that is generated from the two arpeggiators.

Example 1)

On tracks 1 and 2, set **MIDI Channel** (SEQ> MIDI) to **01** and **Status** (SEQ> PROG) to **INT**. Assign arpeggiator A to track 1 and arpeggiator B to track 2, and check **Arpeggiator Run A, B**. In **Track Select**, choose Track01.

With the ARP button off, play the keyboard and tracks 1 and 2 will sound simultaneously.

When you turn on the ARP button and play the keyboard, arpeggiator A will run for track 1 and arpeggiator B will run for track 2.

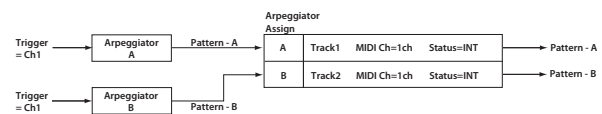

Example 2)

For tracks 1, 2 and 3, set the **MIDI Channel** (SEQ> MIDI) to **01**, **02**, and **03** respectively, and set **Status** (SEQ> PROG) to **INT**. Assign arpeggiator A to tracks 1 and 2, and arpeggiator B to track 3. Check the **Arpeggiator Run A, B** setting.

- In **Track Select**, choose Track01.

Playing the keyboard when the ARP button is **off** will play the sound assigned to track 1.

Playing the keyboard when the ARP button is **on** will cause arpeggiator A to run for tracks 1 and 2, and produce sound for both tracks.

- In **Track Select**, choose Track02.

Playing the keyboard when the ARP button is off will play the sound assigned to track 2.

Playing the keyboard when the ARP button is on will cause arpeggiator A to run for tracks 1 and 2, and produce sound for both tracks.

- In **Track Select**, choose Track03.
 Playing the keyboard when the ARP button is off will play the sound assigned to track 3.
 Playing the keyboard when the ARP button is on will cause arpeggiator B to run for track 3, and play the sound assigned to track 3.
- Alternatively, you could choose Track01 in **Track Select** to run arpeggiator A for tracks 1 and 2, and use an external MIDI device connected to the KROSS's MIDI IN to send note data to MIDI channel 3 to play arpeggiator B.

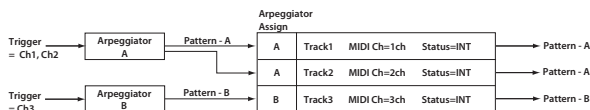

The arpeggiator cannot be triggered by the notes played by the sequencer.



If the track **Status** (SEQ> PROG) is set to INT or BTH, tracks 1–16 where arpeggiator A or B are assigned will be sounded by the note data generated by the arpeggiator, regardless of the **MIDI Channel** (S-TRACK> MIDI) setting of that track. If the track **Status** is set to BTH, EXT, or EX2, the track will transmit MIDI note data on the **MIDI Channel** of that track.

In this case, arpeggiator A or B will be triggered by the **MIDI Channel** of any track 1–16 where the corresponding arpeggiator is assigned.



If the **Local Control On** (G-MIDI> BASIC) setting is turned OFF, the arpeggiator will not be triggered by note data from the keyboard. It will be triggered by note data received at MIDI IN. If you wish to record just the trigger notes on an external sequencer and run the KROSS's arpeggiator in this way, turn Local Control OFF.

If you want the note data generated by the arpeggiator to be recorded on the external sequencer, turn Local Control ON, and turn off the echo back function of the external sequencer. (see page 306)

Track Info.

Shows the settings of tracks 1–16 for the parameter that you're editing.

If this is disabled because of the setting of another parameter, “–” is shown

**7–2: A (Arpeggiator–A),
7–3:B (Arpeggiator–B)**



Pattern*	[P0...P4, U000(INT)...U0899(INT), U0900(USER)...U1027(USER)]
Octave*	[1, 2, 3, 4]
Resolution*	[♪ ₃ , ♪ ₃ , ♪ ₃ , ♪ ₃ , ♪ ₃ , ♪ ₃ , ♪ ₃ , ♪ ₃ , ♪ ₃ , ♪ ₃]
Gate	[000...100%, Step]
Velocity	[001...127, Key, Step]
Swing	[-100...+100%]
Sort*	[Off, On]
Latch*	[Off, On]
Key Sync.*	[Off, On]
Keyboard*	[Off, On]

These settings are the same as for a program.

For more information, please see the “13: P-ARP (Arpeggiator)” section on page 51.

* These parameters can also be set from “0–5: ARP (Arpeggiator)”.

7-4: SCAN ZONE

These settings specify the note and velocity ranges that will use arpeggiators A and B.

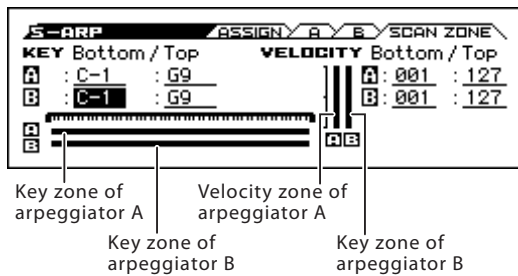

KEY

Bottom Key [C-1...G9]

Top Key [C-1...G9]

Specifies the range of notes (keys) that will use arpeggiator A (B). **Top Key** specifies the upper limit, and **Bottom Key** specifies the lower limit.

VELOCITY

Bottom Velocity [001...127]

Top Velocity [001...127]

Specifies the range of velocities that will use arpeggiator A (B). **Top Velocity** specifies the upper limit, and **Bottom Velocity** specifies the lower limit.

Specifies the range of notes (keys) and velocities that will use arpeggiator A/B.

Note: You can also set the note and velocity values by keyboard (see page 12 of the Operation Guide).

Zone Map

This shows the Scan Zone for each arpeggiator, A and B.

7-1...4: FUNCTION

- 0: **Memory Status** see page 137
- 1: **Solo Setting** see page 63
- 2: **Undo** see page 137
- 3: **Create New Song** see page 137
- 4: **Rename Song** see page 137
- 5: **Delete Song** see page 137
- 6: **Copy From Song** see page 137
- 7: **Copy from Combination** see page 138
- 8: **Copy from Program** see page 139
- 9: **Load Template Song** see page 139
- 10: **Save Template Song (Save as User Template Song)** see page 140
- 11: **GM Initialize** see page 141
- 12: **FF/REW Speed** see page 142
- 13: **Set Location (Set Location for Locate Key)** see page 142
- 14: **Copy Arpeggiator** see page 150

For more information, please see the "Sequencer: FUNCTION" section on page 137.

8: S-DRUM TRACK (Drum Track)

8-1: PATTERN

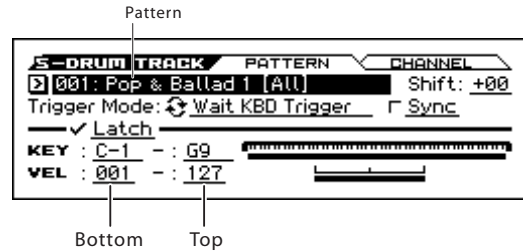

The parameters for the Drum Track function are structured in the same way as in Combination mode. Assign the Drum Track program to the desired track 1-16.

However, while a combination triggers the Drum Track pattern on the global MIDI channel, a song triggers the Drum Track pattern on the MIDI channel specified by Drum Pattern **Input**. Normally you'll set this to Tch. With the Tch setting, the MIDI channel of the track selected by **Track Select** will automatically be used as the trigger channel.

In Sequencer mode you can use the Drum Track function while realtime-recording a song track or pattern.

The note-on/off data transmitted by the Drum Track pattern can be recorded as events in a track.

You can't use note data from the internal sequencer as a trigger to start patterns for the Drum Track function.

When you've used the Drum Track function with a program or combination to come up with an idea for a song, you can then use the Auto Song Setup function to immediately start realtime-recording (see page 101).

MIDI transmission and reception for the drum track

In Sequencer mode, the Drum Track function transmits and receives on the following MIDI channels.

Receive: The drum track will receive on the MIDI channel specified by the Drum Pattern **Input** setting of each song. Normally you'll set this to Tch and use the KROSS's keyboard to control the triggering.

Transmit: The drum track will transmit on the MIDI channel specified by the Drum Pattern **Output** setting of each song. Set this to match the MIDI channel of the MIDI track where you've assigned the drum program.

If the track's **Status** is BTH, EXT, or EX2, note data etc. of the Drum Track pattern will be transmitted.

If local control (Local Control On G-MIDI> BASIC) is on, playing the KROSS's keyboard will not make the internal sound generator produce sound, nor can the keyboard trigger the arpeggiator or drum track. However, they can be triggered by note-on messages from MIDI IN.

Pattern [000, 001...700]

This selects the drum pattern.

Preset/User No.	Contents
000	Off
001...700	Preset drum patterns

Shift [-24...+00...+24]

This transposes the drum pattern in semitone steps. This means that the instruments played by the pattern will change.

Note: If you've selected a GM drum program for the Drum Track, you should set this to -12.

Trigger Mode [Start Immediately, Wait KBD Trig]

Start Immediately: When you press the DRUM TRACK button to turn it on (LED lit), the drum pattern will start according to the **Sync** setting. When you press ON/OFF again, the drum pattern will stop.

Wait KBD Trigger: When you press the DRUM TRACK button to turn it on (LED lit), the drum pattern will wait to start. If you set **Track Select** to a track that matches the MIDI Channel **Input** setting, and play the keyboard, or receive a MIDI note-on on the same MIDI channel, the drum pattern will start according to the **Sync** setting.

 If you've selected **Start Immediately**, the DRUM TRACK button will always be saved in the OFF state.

Sync [Off, On]

Off: The drum pattern will not synchronize to the currently-running arpeggiator or step sequencer, but will start immediately.

On: The drum pattern will synchronize to the currently-running arpeggiator or step sequencer.

Note: Use S-ARP> A(B) Setup **Key Sync** to specify whether arpeggiator will synchronize to the currently-running drum pattern.

Latch [Off, On]

This is valid if **Trigger Mode** is **Wait KBD Trig**.

Off: If the DRUM TRACK button is on (LED blinking), the pattern will start when you play the keyboard (note-on). The pattern will stop when you release the keyboard (note-off).

On: If the DRUM TRACK button is on (LED blinking), the pattern will start when you play the keyboard (note-on). The pattern will continue when you release the keyboard (note-off). The pattern will stop when you turn the DRUM TRACK button off (LED dark).

Zone**KEY**

Bottom [C-1...G9]

Top [C-1...G9]

This is valid if **Trigger Mode** is set to **Wait KBD Trigger**.

It specifies the range of keys that will start the drum pattern.

Vel (Velocity)

Bottom [001...127]

Top [001...127]

This is valid if **Trigger Mode** is set to **Wait KBD Trigger**.

It specifies the range of velocities that will start the drum pattern.

Note: You can also set the note and velocity values by keyboard (see page 12 of the Operation Guide).

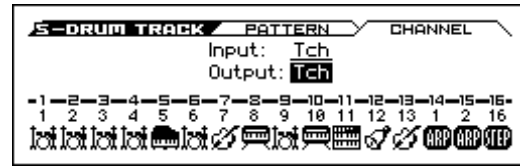
8-2: CHANNEL (MIDI Channel)**Input** [01...16, Tch]

This specifies the MIDI channel that will trigger the drum pattern.

Tch: The MIDI channel that triggers the drum pattern will automatically be set to the MIDI channel (S-TRACK> MIDI) of the track chosen in **Track Select**

If the Trigger Mode is set to Wait KBD Trigger, you can control the trigger by selecting a track of this MIDI channel and playing the keyboard. The Drum Track trigger can be controlled by input from MIDI IN on the matching MIDI channel.

Output [01...16, Tch]

This specifies the MIDI channel that will transmit the MIDI data of the drum pattern. The drum pattern will sound using the program of the track that is assigned to this MIDI channel.

Tch: The MIDI channel output will automatically be set to match the MIDI channel (S-TRACK> MIDI) of the track selected by **Track Select**.

Whether the pattern data will be output to an external device will depend on the **Status** setting of the track that matches the **Output** MIDI channel.

Track Info.

Shows the settings of tracks 1-16 for the parameter that you're editing.

If this is disabled because of the setting of another parameter, “_” is shown

 In this page, you can't use cursor buttons ◀▶ to select timbres.

8-1, 2: FUNCTION

- 0: **Memory Status** see page 137
- 1: **Solo Setting** see page 63
- 2: **Undo** see page 137
- 3: **Create New Song** see page 137
- 4: **Rename Song** see page 137
- 5: **Delete Song** see page 137
- 6: **Copy From Song** see page 137
- 7: **Copy from Combination** see page 138
- 8: **Copy from Program** see page 139
- 9: **Load Template Song** see page 139
- 10: **Save Template Song (Save as User Template Song)** see page 140
- 11: **GM Initialize** see page 141
- 12: **FF/REW Speed** see page 142
- 13: **Set Location (Set Location for Locate Key)** see page 142
- 14: **Copy Drum Track** see page 150

For more information, please see the “Sequencer: FUNCTION” section on page 137.

Synchronizing the Drum Track function

The Trigger "Sync" parameter

The trigger timing of a drum track will depend on the setting of its Trigger Sync parameter.

On (checked): The trigger timing will be quantized to the nearest beat relative to the base tempo.

Off (unchecked): If **Trigger Mode** is Start Immediately, triggering will occur at the moment you press the DRUM TRACK button. If this is set to Wait KBD Trig, triggering will occur at the moment you play the keyboard.

Synchronizing the drum track with the arpeggiator function, Sequencer mode songs

If you want the Drum Track pattern to play or be recorded in synchronization with the currently-running arpeggiator function, or currently-playing song, turn Trigger Sync on.

Trigger Sync Off: If the **Trigger Mode** setting is Start Immediately, the Drum Track pattern will be triggered the moment you press the DRUM TRACK button. If this is set to Wait KBD Trigger, the Drum Track pattern will be triggered the moment you play the keyboard. It will not synchronize to the currently-running arpeggiator function or to the currently-playing song.

Trigger Sync On: Triggering will synchronize to the currently-playing song at the beginning of the next measure. Triggering will synchronize to the arpeggiator that's currently running (in Sequencer mode if the song is stopped) on the next beat.

Note: If you want to synchronize the arpeggiator to the currently-running Drum Track function, set the **Key Sync** parameter (P/C/S-ARP).

Synchronization with song stop

Synchronization with a song in Sequencer mode

- When you press the START/STOP (▶/■) button, the Drum Track function and the sequencer will stop.
- If you want the Drum Track function to start simultaneously with the beginning of recording, press the DRUM TRACK button during the pre-count before recording (if the **Trigger Mode** is set to Start Immediately) or play the keyboard (if **Trigger Mode** is Wait KBD Trig). The Drum Tracks will not be triggered immediately, but will be triggered in synchronization with the sequencer the moment recording starts.

Slave operation

The KROSS's sequencer can be made to run in synchronization with the clock and realtime commands received from an external sequencer. Connect the MIDI OUT of your external MIDI device to the KROSS's MIDI IN, or connect the KROSS's USB port to your computer's USB port.

Connect the KROSS's MIDI IN to your external MIDI device's MIDI OUT, or connect the KROSS's USB connector to your computer's USB port.

Set **MIDI Clock** (see page 160) to Ext-MIDI or Ext-USB. The KROSS will synchronize to the **MIDI Clock** and the realtime command messages it receives from the connected MIDI device.

Note: If the KROSS is set to **MIDI Clock**= Auto, it will also synchronize to the external MIDI device in the same way if MIDI realtime clock messages are being received from the external device.

Synchronization to MIDI dock

The arpeggiator will synchronize to the tempo coming from an external MIDI clock source.

Synchronization with MIDI realtime commands

In Sequencer mode, the KROSS will respond to Song Start, Continue, and Stop messages that it receives just as it does when using the front panel START/STOP (▶/■) button to control song playback and recording. The arpeggiator also will be controlled in the same way. (See "Synchronization with song stop" above)

Master operation

The KROSS sequencer's clock data and start/stop operations can be used to synchronize and control an external sequencer.

Connect the KROSS's MIDI OUT to your external MIDI device's MIDI IN, or connect the KROSS's USB connector to your computer's USB port.

Set **MIDI Clock** (G-MIDI> BASIC) to Internal. The connected external MIDI device will synchronize to the KROSS's MIDI Clock.

Note: The same applies if **MIDI Clock**=Auto and MIDI Clock messages are being transmitted. For details, please see "MIDI Clock (MIDI Clock Source)" on page 160.

Synchronization via MIDI clock

The connected external MIDI device will synchronize to the MIDI clock of the KROSS.

9: S-STEP SEQ (Step Sequencer)

Here you can adjust settings for the step sequencer used by the sequencer.

Note: To use the step sequencer, turn STEP SEQ On/Off “on” (SEQ> MAIN or PROG page).

MIDI transmission/reception for the step sequencer

Step sequencer functions in Sequencer mode are transmitted and received using the MIDI channel of track 16.

 The on/off state of the RUN button cannot be saved.

9-1: BASIC



Program [000...(040)]

Here you can select the drum program that will be used by the step sequencer.

This parameter is linked with the program select (SEQ> PROG page) of track 16 when STEP SEQ is on.

Tempo [40.00... 300.00, EXT]

Resolution [♩, ♪, ♫, ♮, ♯, ♭, ♮, ♯, ♭, ♮, ♯, ♭]

Lgth (Length) [01...64]

Step/Bt (Steps per Beat for Swing) [x1, x2, x4]

These settings are the same as for a program.

See “15-1: BASIC” on page 55

9-2: EDIT

Indicates the tone for which you can use the front panel 1-16 buttons to turn steps on/off.

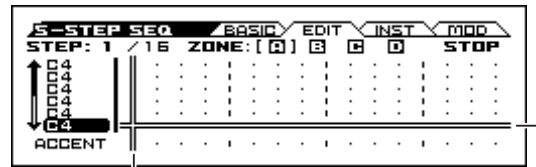

When you turn RUN on, the indication will move to the left, showing the currently-playing step.

STEP */#	[1...64/01...64]
ZONE	[A, B, C, D]
STATUS	[STOP, RUN]
TONE 01 (Kick/Note No.)	[Step Off, On]
TONE 02 (Snr 1/Note No.)	[Step Off, On]
TONE 03 (Snr 2/Note No.)	[Step Off, On]
TONE 04 (H.H X/Note No.)	[Step Off, On]
TONE 05 (H.H O/Note No.)	[Step Off, On]
TONE 06 (Crash/Note No.)	[Step Off, On]
TONE 07 (Ride/Note No.)	[Step Off, On]
TONE 08 (Tom L/Note No.)	[Step Off, On]
TONE 09 (Tom H/Note No.)	[Step Off, On]
TONE 10 (Perc 1/Note No.)	[Step Off, On]
TONE 11 (Perc 2/Note No.)	[Step Off, On]
TONE 12 (SFX/Note No.)	[Step Off, On]
ACCENT	[Off, On]

These settings are the same as for a program.

See “15-2: EDIT” on page 56

9-3: INST (Instruments)

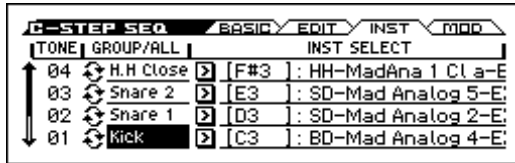

TONE 01 GROUP/ALL	[Kick, ALL]
TONE 02 GROUP/ALL	[Snare 1, ALL]
TONE 03 GROUP/ALL	[Snare 2, ALL]
TONE 04 GROUP/ALL	[H.H Close, ALL]
TONE 05 GROUP/ALL	[H.H Open, ALL]
TONE 06 GROUP/ALL	[Crash, ALL]
TONE 07 GROUP/ALL	[Ride, ALL]
TONE 08 GROUP/ALL	[Tom L, ALL]
TONE 09 GROUP/ALL	[Tom H, ALL]
TONE 10 GROUP/ALL	[Perc 1, ALL]
TONE 11 GROUP/ALL	[Perc 2, ALL]
TONE 12 GROUP/ALL	[SFX, ALL]

These settings are the same as for a program.
See "15-3: INST (Instrument)" on page 57

9-4: MOD (Modulation)



MODULATION CONTROLS

Velocity	[-64...+0...+63]
Swing	[-64...+0...+63]
Accent	[-64...+0...+63]

These settings are the same as for a program.
See "15-4: MOD (Modulation)" on page 57

9-1...4: FUNCTION

- 0: Memory Status see page 137
- 1: Solo Setting see page 63
- 2: Undo see page 137
- 3: Create New Song see page 137
- 4: Rename Song see page 137
- 5: Delete Song see page 137
- 6: Copy From Song see page 137
- 7: Copy from Combination see page 138
- 8: Copy from Program see page 139
- 9: Load Template Song see page 139
- 10: Save Template Song (Save as User Template Song) see page 140
- 11: GM Initialize see page 141
- 12: FF/REW Speed see page 142
- 13: Set Location (Set Location for Locate Key) see page 142
- 14: Assign inst to Tone see page 65
- 15: Edits Step Parameters see page 65
- 16: Copy Step Seq see page 65

For more information, please see the "Sequencer: FUNCTION" section on page 137.

10: S–FX ROUTING (Effect Routing)

You can also specify the bus routing for the program used by each MIDI track 1–16. For instance, you can:

- Send the output of a track to an insert effect
- Route a sound to an insert effect
- Create detailed settings for insert effects

For details on Insert Effects, please see “Effect Guide” on page 197.

10–1: BUS

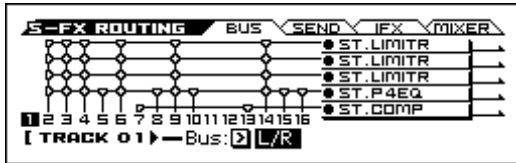

Specifies the bus where the program oscillator(s) used by MIDI tracks 1–16 will be sent. You can also set the send levels to the master effects from this page.

Routing Map

This area shows the insert effect routing (**Bus Select**), the name of the assigned effect, the on/off status, chaining, and the output bus that follows the insert effect. The type of insert effect, the on/off status, and the chain settings can be edited in the S–FX ROUTING> IFX page.

Track 01...16 (Track Number)

To select a track, place the cursor at one of the following parameters, and use the cursor buttons ◀▶ to switch tracks. (see page 105)

Bus Select [DKit, L/R, IFX1...5, Off]

This specifies the output bus for the track program’s oscillator(s).

L/R: Output to the L/R bus.

IFX1, 2, 3, 4, 5: Output to the IFX1–5 buses.

Off: The track will not be output from the L/R bus, or IFX1–5 buses. Choose the Off setting if you want the program’s oscillator output of the track to be connected in series to a master effect. Use SEND page **Send1 (to MFX1)** and **Send2 (to MFX2)** to specify the send levels.

Tip: You can create a wide variety of routings by using each track’s **Bus Select** and the **Chain to** and **Chain** settings (SEQ> MIXER) that follow the insert effect.

DKit: You can select this only if the specified program is a drum program (**OSC: Drums**).

The **Bus Select**, **FX Control Bus**, **Send1**, and **Send2** settings (GLOBAL DRUM KIT> VOICE) for each key of the selected drum kit will be used. Check this setting if you want to apply an individual insert effect to each drum instrument.

Tip: In most preloaded drumkits, the drum instruments have the same **Bus Select** settings according to their type, as follows.

Snares → IFX1

Kicks → IFX2

Cymbals → IFX3

Tam, percussions, and others → IFX4

If you want to edit these routings, use the **DKit IFX Patch** function. For more information, please see “DKit IFX Patch” on page 96.

10–2: SEND



Track 01...16 (Track Number)

To select a track, place the cursor at one of the following parameters, and use the cursor buttons ◀▶ to switch tracks. (see page 105)

FX Control Bus [Off, FC1, FC2]

Sends the output of the track to an FX Control bus (two-channel mono FX Ctrl 1 or 2).

Use the FX Control busses when you want a separate sound to control the audio input of an effect. You can use two FX Control busses (each is a two-channel mono bus) to control effects in various ways.

For more information, please see the “FX Control Bus” section on page 199.

Send1 (MFX1) [000...127]

Send2 (MFX2) [000...127]

For each track, these parameters set the send level to master effects 1 and 2. These settings are valid when **Bus Select** is set to L/R or Off. When IFX 1–5 are selected, the send levels to master effects 1 and 2 are set by the **Send1** and **Send2** parameters of the IFX page, and are applied after the sound has passed through IFX1–5.

The Send 1 and 2 settings you specify here are used during playback or recording from the beginning of the song. If you modify these settings during recording, your changes will be recorded as performance data; the send amounts will change accordingly during playback. You can also modify these settings during playback. However if Send 1 and 2 data has been recorded, the settings will change according to the recorded data.

If Bus Select is set to IFX1–5, this setting is ignored.

If **Status** (SEQ> PROG) is either INT or BTH, CC#93 and CC #91 can control send 1 and 2 respectively and change their settings. When you switch songs or return to the beginning of a song, tracks where the **Status** is EXT, EX2 or BTH will transmit these settings via MIDI. This data will be transmitted on the MIDI channel of each track as set by **MIDI Channel** (S–TRACK> MIDI). The actual send level is determined by multiplying the value of these parameters with the send level settings of the program used by the track (**Send1** and **Send2**, P–FX ROUTING> SEND). (See G–MIDI> OUT: SEQ Mode “Track MIDI Out” on page 161)

Track Info.

Shows the settings of tracks 1–16 for the parameter that you’re editing.

If this is disabled because of the setting of another parameter, “–” is shown.

10-3: IFX (Insert FX Setup)

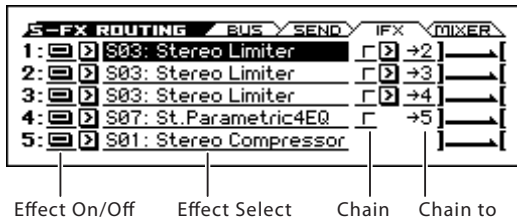

Here you can choose the type of each insert effect 1 through 5, its on/off status, chaining, and adjust the post-IFX mixer settings. For insert effects, the direct sound (Dry) is always stereo-in and out. The input/output configuration of the effect sound (Wet) depends on the effect type. For descriptions of the individual effects, please see “Effect Guide,” beginning on page 197.

The following parameters are the same as in Program mode. For more information, please see “16-3: Insert FX Setup” on page 602.

However, unlike in Program mode, insert effect dynamic modulation (Dmod) and the post-IFX **Pan: #8**, **Send 1**, and **Send 2** are controlled on the MIDI channel specified by **Ch** (S-IFX> IFX1-5). The control changes used are the same as in Program mode.

The pan (CC#8), send 1 and 2 settings you make here will be used when the song is played or recorded from the beginning. If you change the settings while recording a MIDI track, the changes will be recorded as part of the musical data, and the settings will change when the data is played back. You can also change these settings during playback. However if pan (CC#8), send 1, or 2 data has been recorded, the settings will change accordingly.

MIDI If **Status** (SEQ> PROG) is either INT or BTH, CC#8, CC#93, and CC#91 can be received to control the pan following the insert effect, send 1, or send 2 respectively, and change their settings. When you switch songs or return to the beginning of the song, tracks whose **Status** is BTH, EXT, or EX2 will transmit these settings via MIDI. This data will be transmitted on the MIDI channels specified in the IFX 1-5 pages (S-IFX> IFX1-5). (See G-MIDI> OUT: SEQ Mode “Track MIDI Out” on page 161)

1 (IFX1)

Effect On/Off [Off, On]

Effect Select [000, S00...S63, D00...D10]

Category/IFX Select menu:

Chain [Off, On]

Chain to [2...5]

2 (IFX2)

Effect On/Off [Off, On]

Effect Select [000, S00...S61, D00...D09]

Chain [Off, On]

Chain to [3...5]

3 (IFX3)

Effect On/Off [Off, On]

Effect Select [000, S00...S61, D00...D09]

Chain [Off, On]

Chain to [4, 5]

4 (IFX4)

Effect On/Off [Off, On]

Effect Select [000, S00...S61, D00...D09]

Chain [Off, On]

5 (IFX5)

Effect On/Off [Off, On]

Effect Select [000, S00...S61]

These settings are the same as for a program.

See “16-3: Insert FX Setup” on page 60

10-4: MIXER

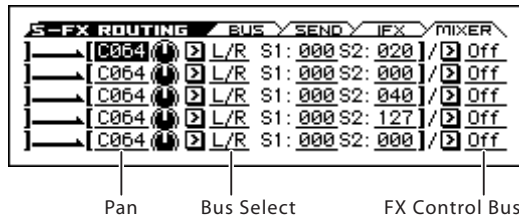

1...5 (IFX 1...5)

Pan	[L000...C064...R127]
Bus Select	[Off, L/R]
Send1	[000...127]
Send2	[000...127]
FX Control Bus	[Off, FC1, FC2]

These settings are the same as for a program.

See "16-4: MIXER" on page 61

10-1...4: FUNCTION

- 0: **Memory Status** see page 137
- 1: **Solo Setting** see page 63
- 2: **Undo** see page 137
- 3: **Create New Song** see page 137
- 4: **Rename Song** see page 137
- 5: **Delete Song** see page 137
- 6: **Copy From Song** see page 137
- 7: **Copy from Combination** see page 138
- 8: **Copy from Program** see page 139
- 9: **Load Template Song** see page 139
- 10: **Save Template Song (Save as User Template Song)** see page 140
- 11: **GM Initialize** see page 141
- 12: **FF/REW Speed** see page 142
- 13: **Set Location (Set Location for Locate Key)** see page 142
- 14: **Copy Insert Effect** see page 151
- 15: **Swap Insert Effect** see page 151
- 16: **DKit IFX Patch** see page 151

For more information, please see the "Sequencer: FUNCTION" section on page 137.

11: S-IFX

11-1: IFX1 (Insert Effect1)



Here you can edit the parameters of the insert effect 1, which you selected in the S-FX ROUTING> IFX page.

Effect On/Off [Off, On]

Turns the insert effect on/off. This is linked with the On/Off setting in the S-FX ROUTING> IFX page.

Ch (Control Channel) [Ch01...16, All-R]

This specifies the MIDI channel that will control dynamic modulation (Dmod) for the insert effect.

Ch01...Ch16: The insert effect will be controlled on the specified MIDI channel.

All-R: The channel of any track routed through this effect can be used to control the effect. (Channels of each routed track will be indicated by "**".)

▲ If a Track is using a Drum Kit, and the Track's **Bus Select** (S-FX ROUTING> BUS) is **DKit**, this affects the MIDI Control Channel as well. In this case, the Track's MIDI channel will be used to control any effect where the **Ch** is set to All-R, regardless of the **Bus Select** (Global DRUMKIT> VOICE) settings or the settings of the **DKit IFX Patch** function.

IFX1 Parameters

Here you can set the effect parameters of the insert effect you chose in the S-FX ROUTING> IFX page.

For more information, please see the "Insert Effects (IFX1-IFX5)" section on page 200.

11-2: IFX2 (Insert Effect2),

11-3: IFX3 (Insert Effect3),

11-4: IFX4 (Insert Effect4),

11-5: IFX5 (Insert Effect5)

Here you can edit the effect parameters for insert effects 2-5 selected in the Insert FX Setup page.

For more information, please see "8-4: IFX1" above.

11-1...5: FUNCTION

- 0: **Memory Status** see page 137
- 1: **Solo Setting** see page 63
- 2: **Undo** see page 137
- 3: **Copy Insert Effect** see page 151
- 4: **Swap Insert Effect** see page 151
- 5: **FF/REW Speed** see page 142
- 6: **Set Location (Set Location for Locate Key)** see page 142

For more information, please see the “Sequencer: FUNCTION” section on page 137.

12: S-MFX (Master Effect)

Here you can adjust the settings for the master effects. For instance, you can:

- Route a sound to the master effects.
- Create detailed settings for the master effects.

For more information, please see the “Effect Guide” section on page 197.

12-1: SETUP

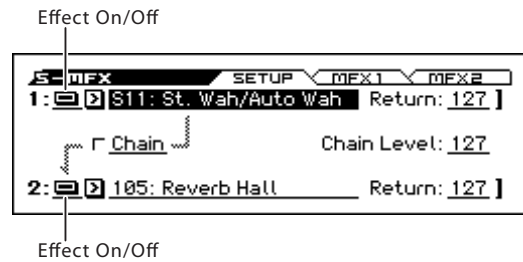

- Here you can specify the type of master effects, and turn them On/Off.
- The master effects are sent to the L/R bus.

These parameters are the same as in Program mode.

For more information, please see the “18-1: SETUP” section on page 62.

1 (MFX1)

Effect On/Off	[Off, On]
Effect Select	[000,S01...S87, D00...D13]
Return 1	[000...127]
Chain	[Off, On]
Chain Level	[000...127]

2 (MFX2)

Effect On/Off	[Off, On]
Effect Select	[000...120]
Return 2	[000...127]

These parameters are the same as in Program mode.

For more information, please see the “18-2: MFX1 (Master Effect 1)” section on page 62.

12-2: MFX1 (Master Effect1)

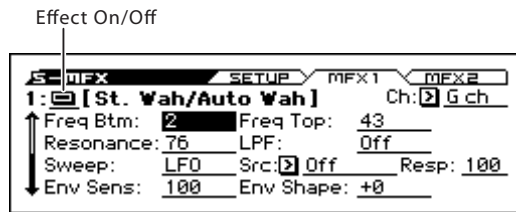

Here you can edit the parameters of the effect that you selected for MFX1 in the S-MFX> SETUP page.

Effect On/Off [Off, On]

This turns master effect 1 on/off. This is linked with the on/off setting in the S-MFX> SETUP page.

Ch (Control Channel) [Ch01...16, G ch]

Specifies the MIDI channel that will control dynamic modulation (Dmod) for the master effect.

Ch01...Ch16: The specified MIDI channel will be used for control.

G ch: The global **MIDI Channel** (G-MIDI> BASIC) will be used for control. Normally you will use the G ch setting.

MFX1 Parameters

Here you can set the effect parameters of the effect that you chose in the S-MFX> SETUP page.

For details on the individual effects, please see the “Effect Guide” on page 197.

12-3: MFX2 (Master Effect2)

These pages let you edit the parameters of Master Effect 2. To select different effects types, use the S-MFX> SETUP page.

The parameters of MFX2 is the same as for MFX1. For more information, please see “12-2: MFX1” above.

∨ 12-1...3: FUNCTION

- 0: **Memory Status** see page 137
- 1: **Solo Setting** see page 63
- 2: **Undo** see page 137
- 3: **Copy Master Effect** see page 151
- 4: **FF/REW Speed** see page 142
- 5: **Set Location (Set Location for Locate Key)** see page 142

For more information, please see the “Sequencer: FUNCTION” section on page 137.

Sequencer: FUNCTION

Procedure for each function

1. Press the FUNCTION button to open the function list.
2. Adjust settings in the dialog box.

For details on the settings in each dialog box, refer to the explanation of each function.

3. Press the OK button to execute, or press the Cancel button if you decide not to execute.

Memory Status

This displays the remaining amount of sequencer memory. It is available on every page in Sequencer mode.



Solo Setting

This specifies how the Solo function will work. It is available on every page in Sequencer mode.

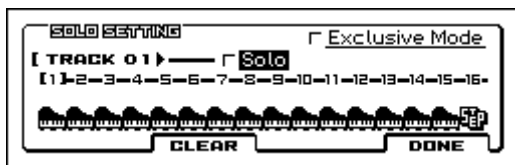

For more information, please see the “Solo Setting” section on page 63.

Undo

Use this to compare the before-and-after states of realtime recording or track editing.

It is available on every page in Sequencer mode.
(see page 12 of the Operation Guide)

Create New Song

Create Song is available on all of the tabs under the SEQ, S-INPUT/CTRL, S-LOOP/TONE, S-TRACK, S-ZONE/DELAY, S-MIDI FILTER, S-TRACK EDIT, S-ARP, S-DRUM TRACK, S-STEP SEQ, S-FX ROUTING pages.

Creates a new song.

Set Length [001...999]

Specifies the length of the song that you want to create, as a number of measures.

Note: If you want to change the length after creating the song, execute the Track Edit function Set Song Length. When creating a new song, you can specify a length that's somewhat greater than you think you'll need, and then after you've finished recording and editing, use Set Song Length to specify the correct length.

Select the number [Off, On] [000...127]

Specify the song number of the song that you want to create. If this is not checked (i.e., if it is off), the song will be created in the first unused number.

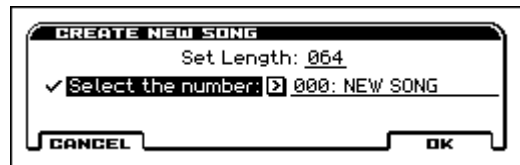

Rename Song

Rename Song is available on all of the tabs under the SEQ, S-INPUT/CTRL, S-LOOP/TONE, S-TRACK, S-ZONE/DELAY, S-MIDI FILTER, S-ARP, S-DRUM TRACK, S-STEP SEQ, S-FX ROUTING pages.

Here you can rename the selected song. A name of up to 24 characters can be input.

For more information, please see “Editing names” on page 105 of the Operation Guide.

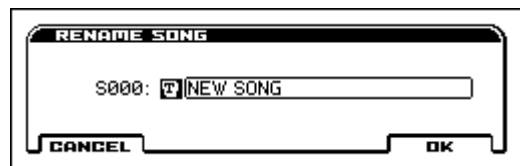

Delete Song

Delete Song is available on all of the tabs under the SEQ, S-INPUT/CTRL, S-LOOP/TONE, S-TRACK, S-ZONE/DELAY, S-MIDI FILTER, S-ARP, S-DRUM TRACK, S-STEP SEQ, S-FX ROUTING pages.

This command deletes the currently selected song.

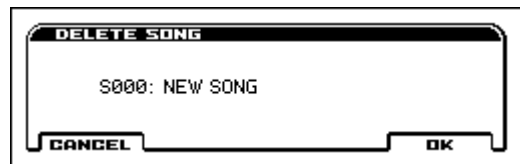

When you execute this command, the musical data, and setting data etc. of the currently selected song will be erased, and the memory area allocated to that song will be freed.

Copy From Song

Copy From Song is available on all of the tabs under the SEQ, S-INPUT/CTRL, S-LOOP/TONE, S-TRACK, S-ZONE/DELAY, S-MIDI FILTER, S-ARP, S-DRUM TRACK, S-STEP SEQ, S-FX ROUTING pages.

This command copies all of the setting data and musical data from the specified song to the currently selected song.

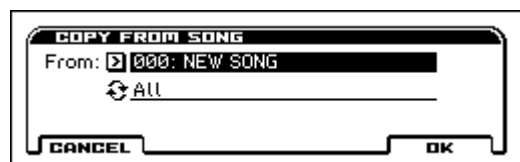

1. In From, specify the copy source song number.
2. Select the data that you wish to copy.

All: will copy all setting data and musical data.

Without Track Events: will copy only the setting data of songs, except for Play Loop.

Be aware that if you execute **All**, all setting data and musical data of the currently selected song will be erased and rewritten by the data from the copy source song. If you execute **Without Track Events**, song setting data will be rewritten.

Copy from Combination

Copy From Combination is available on all of the tabs under the SEQ, S-INPUT/CTRL, S-LOOP/TONE, S-TRACK, S-ZONE/DELAY, S-MIDI FILTER, S-ARP, S-DRUM TRACK, S-STEP SEQ, S-FX ROUTING pages.

This command copies the parameters of the specified combination to the setting data of the currently selected song.

Note: Only the timbres used by the combination will be copied. Timbres in the combination whose Status is Off will not be copied. If any timbres are set to Mute, the corresponding tracks of the song will be set to a **Status** of Off.



1. In Combination, select the copy source destination.
2. Use the IFXs, MFXs check boxes to specify whether you want the effect settings of the combination to be copied as well.

IFXs: All insert effect settings of the copy-source combination (the contents of the Insert FX Setup page and the IFX1-5 effect parameters) will be copied.

MFXs: All master effect settings of the copy-source combination will be copied.

3. Specify the desired Auto adjust Arp setting for Multi REC setting.

You have the option of checking the **Auto adjust Arp setting for Multi REC**. As necessary, this function will adjust the MIDI channel etc. of any tracks that need to be changed, and/or add new tracks, in order to ensure that when you perform multi-recording with the arpeggiator on, the same sound will be reproduced during recording as during playback.

Note: This function makes adjustments depending on the ARP state of the combination. When you copy a combination that was written with the arpeggiator turned off, it is assumed that you will leave the arpeggiator off in the song. If you want to use the arpeggiator in the song, you should write the combination with the arpeggiator turned on, and then copy it to the song.

If this is **checked**, the MIDI channels etc. of the tracks will be corrected. **Multi REC** (SEQ> MAIN, REC) and **PLAY/MUTE/REC** (SEQ> REC) will also be set automatically.

In addition, **Recording Setup**, **Overwrite** (SEQ> REC) will be selected. (Note that the automatically-set **Multi REC** and **PLAY/MUTE/REC** will be reset when you re-select the song.)

Note: For details on the data that will be adjusted, see below. The content described here will be corrected automatically. Depending on the settings of the combination, it may be necessary to make additional changes to the track settings in addition to the settings here.

If the recorded performance is not reproduced correctly during playback

If you use the function **Copy From Combination** to copy the settings of a combination, and then perform multi-track recording with the arpeggiator turned on, there may be cases where the performance during recording is not reproduced correctly during playback.

Multiple tracks that are set to the same MIDI channel are combined into a single stream of performance data during recording. If there is a track with the same MIDI channel as the track being played by the arpeggiator, the data played by the arpeggiator will be combined with the performance data that was played manually, and all of this data will be sounded by each track of the same channel (if **Status** is INT).

In such cases, you can solve the problem by creating a track that will drive the arpeggiator on a different MIDI Channel.

If the recorded performance is not reproduced by the playback, check the following conditions.

These settings can be executed automatically if you check **Auto adjust Arp setting for Multi REC** in the function **Copy from Combination**. Normally, you will check this to execute the settings. In this case, these adjustments will not be necessary, but you can verify here that the automatic adjustments have been made.

- S-ARP>ASSIGN page: **ARP Assign** settings



- SEQ> ARP page: Arpeggiator Run A, B settings

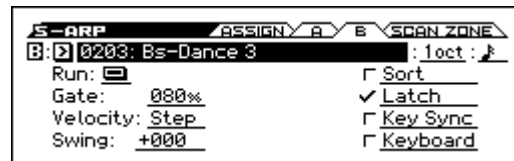
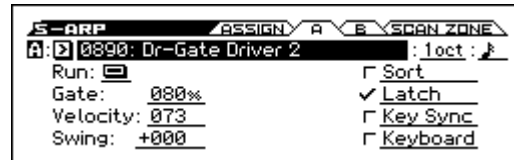

- S-TRACK> MIDI page: **MIDI Channel** settings

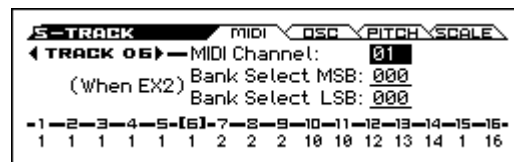

If **Arpeggiator Run A** and **B** are checked, and the arpeggiator is assigned to a track, make sure that **MIDI Channel** (G-MIDI> BASIC) is set to other than 01.

Make sure that the global MIDI channel (Global mode **MIDI Channel**) is set to 01.

Arpeggiator Run	MIDI Channel ^a	Correction
If either "A" or "B" are checked	01 only	Correction required
	01 02, 01 03, etc.	No correction required
If both "A" and "B" are checked	01 only	Correction required
	01 02, 01 03, etc.	Correction required for only one
	01 02 03, etc.	No correction required/ Correction required ^b

- a. If the **MIDI Channel** of multiple tracks used by the arpeggiator is set only to 01, refer to the lines for “01 only.” If the **MIDI Channel** settings are 01 and one other channel, such as 01 and 02, then refer to the lines for “01 02, etc.” If the **MIDI Channel** settings are 01 and multiple other MIDI channels, such as 01 and 02 and 03, then refer to the line for “01 02 03, etc.”
- b. Correction is necessary only if the tracks used by a single arpeggiator are using only **MIDI Channel** 01. In some cases, correction may also be necessary if the two arpeggiators use the same MIDI channel.

 Depending on the combination settings, it may also be necessary to change the track settings as well.

The preceding illustration shows the example of copying the combination “SYNTH PAD 016 (B046): Reed Rhythm” with **Auto adjust Arp setting for Multi REC** un-checked in **Copy From Combination**. Select a new song, and execute the copy to see the result. (For more about the arpeggiator settings in this combination, see page 84.)

Using these settings as an example, determine whether correction is necessary, and if so, what needs to be corrected.

Arpeggiator Run A and B are checked, and **MIDI Channel** 01 and 02 are selected. Correction is necessary for one of the arpeggiators. If you execute multi-track recording with these settings, T01–T06 will have the same MIDI channel, meaning that the synth pad played from the keyboard (T05) and the performance data for the rhythmically gated synths played by arpeggiator A (T01, 02, 03, 04, 06) will be combined, and your performance will not be reproduced when you play back. T15 is a dummy track used to trigger arpeggiator A.

1. So that the rhythm performance data of the gated notes generated by arpeggiator A will be recorded separately, change the MIDI channel of T06.

Select the S–TRACK> MIDI page, and change the T06 **MIDI Channel** to 03.

2. Add settings for triggering arpeggiator A.

For track 12 (or any unused track), turn **Status** Off, and set the **MIDI Channel** to 01. (T12 will be a dummy track used to trigger arpeggiator A.)

3. Select the S–ARP> ASSIGN page. Set the track 12 Assign to A.

This will produce the following settings.

Track	T01	T02	T03	T04	T05	T06	T07	T08	T09	T12	T16
Assign	Off	Off	Off	Off	Off	A	B	B	B	A	B
Status	INT	INT	INT	INT	INT	INT	INT	INT	INT	Off	Off
MIDI Ch.	01	03	01	01	01	03	02	02	02	01	01

This completes the corrections. In the Sequencer P0: Play/REC–Preference page, set **Track Select** to any track whose MIDI channel is 01. Check the **Multi REC** check box and perform multi-track recording (REC tracks T01, 06, 07, 10, 16).

Copy from Program

Copy from Program is available on all of the tabs under the SEQ, S–INPUT/CTRL, S–LOOP/TONE, S–TRACK, S–ZONE/DELAY, S–MIDI FILTER, S–ARP, S–DRUM TRACK, S–STEP SEQ, S–FX ROUTING pages.

This command copies settings from the program you specify to the currently selected song.

This is the same function as in Combination mode; for details, please see “Copy from Program” on page 95.

This command in Sequencer mode differs from its behavior in Combination mode in that the channels assigned to the tracks of the song will be preserved regardless of the **with Arp** setting of the copy-destination track’s **MIDI Channel**. (See step 4.)



Load Template Song

Load Template Song is available on all of the tabs under the SEQ, S–INPUT/CTRL, S–LOOP/TONE, S–TRACK, S–ZONE/DELAY, S–MIDI FILTER, S–ARP, S–DRUM TRACK, S–STEP SEQ, S–FX ROUTING pages.

This command loads a template song.

The built-in sequencer contains sixteen different **preset template songs** (P00–15) that contain settings for programs and effects appropriate for various musical styles. You are also free to create your own favorite settings for programs, track parameters, and effects, and save them as one of sixteen **user template songs** (U00–15). For more information, please see the “Save Template Song (Save as User Template Song)” section on page 140.

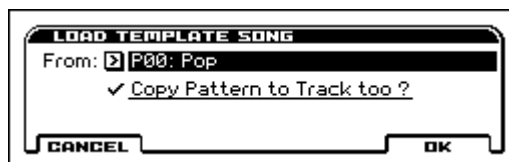

1. In **From**, specify the template song that you wish to load.
2. If you check **Copy Pattern to Track too?**, the **Copy Pattern To Track** dialog box will appear automatically after **Load Template Song** has been executed.

If you execute **without checking** this, only the template song you specified in step 2 will be loaded.

When you execute, song settings other than Play Loop will be copied.

If in step 2 you checked **Copy Pattern to Track too?** and pressed the OK button, the **Copy Pattern To Track** dialog box will appear.

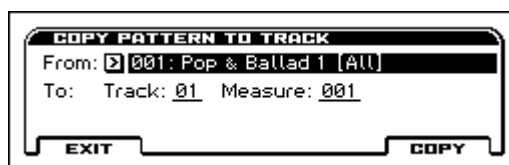

Use the **From** field to select the drum pattern that you want to copy.

Press the SEQUENCER START/STOP (▶ / ■) button; the selected pattern will play.

This dialog box is the same as in the function **Copy To Track**.

3. In **To Track**, select the copy destination track.

In **Measure**, specify the beginning measure of the copy destination.

Note: Track 1 of all sixteen preset template contains a drum category program.

The pattern names of the preset patterns indicate the musical genre and part of the optimal drum category program.

By loading the drum track for these preset template songs and the corresponding preset patterns, you can efficiently set up a drum track that is suited to each preset template song.

When you execute, **Measure** will count up automatically. You may then copy patterns as well. To exit the command, press the **Exit button**.

For details on how to copy preset patterns to a song along with the preset template song, please see “Using template songs” on page 55 of the Operation Guide.

Save Template Song (Save as User Template Song)

Save Template Song is available on all of the tabs under the SEQ, S-INPUT/CTRL, S-LOOP/TONE, S-TRACK, S-ZONE/DELAY, S-MIDI FILTER, S-ARP, S-DRUM TRACK, S-STEP SEQ, S-FX ROUTING pages.

This command saves the program selections, track parameters, and effect settings etc. of the current song as a user template song U00–15. The settings you save here can also be loaded in Song Play mode.



1. In **To**, specify the user template song (U00–15) where the data will be saved.

Be aware that when you execute this command, all settings of the destination Template will be erased and rewritten with the current settings.

Note: The Play Loop settings are not saved. If you want to save these setting, execute **Save SEQ** in Media mode and save them to an SD card.

GM Initialize

GM Initialize is available on all of the tabs under the SEQ, S-INPUT/CTRL, S-LOOP/TONE, S-TRACK, S-ZONE/DELAY, S-MIDI FILTER, S-ARP, S-DRUM TRACK, S-STEP SEQ, S-FX ROUTING pages.

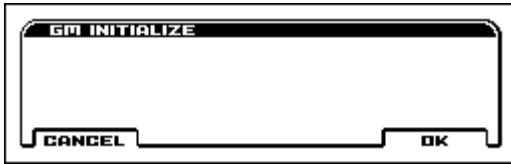

This command transmits a GM System On message to the Sequencer mode, resetting all tracks to the GM settings. For more information, please see the “GM Initialize” section on page 141.

MIDI In Sequencer mode, when a GM System On message is received from an external device, or if a GM System On message is recorded in the sequence data, the KROSS will be reset to settings appropriate for GM just as if you had executed this command. However, in these cases, the various S-MFX parameters will not be reset.

GM Initialize List

Page	Page	Parameter	Track 1-9, 11-16	Track 10	
SEQ	PROG	Program Select	G001	g(d)001	
		Status	-	-	Setting remains unchanged
		Use Step Seq	-	-	Off
	MIX	Play/Mute, Solo	-	-	Setting remains unchanged
		Pan	C064	C064	
Volume		100	100		
S-TRACK	MIDI	MIDI Channel	-	-	Setting remains unchanged
		Bank Select MSB/LSB	000	000	
	OSC	Force OSC Mode	-	-	Setting remains unchanged
		OSC Select	-	-	Setting remains unchanged
		Portamento	Off	Off	
	PITCH	Transpose	+00	+00	
		Detune	+0000	+0000	
Bend Range		+02	+02		
SCALE	Use Program's Scale	-	-	Setting remains unchanged	
S-ZONE/ DELAY	KEY ZONE	TRACK 01-16	C-1...G9 (Slope=000)	C-1...G9	
	VEL ZONE	TRACK 01-16	001...127 (Slope=000)	001...127	
	Delay	MIDI Tempo Sync.	Off	Off	
Time		0000	0000		
S-MIDI FILTER	1, 2, 3, 4	MIDI Filter	On	On	
S-ARP	-	Various parameters		-	Setting remains unchanged
S-DRUM TRACK	-	Various parameters		-	Setting remains unchanged
S-STEP SEQ	-	Various parameters			
S-FX ROUTING	BUS	Bus Select	L/R	L/R	
		Send1 (MFX1)	0	0	
	SEND	Send2 (MFX2)	40	40	
		FX Control Bus	-	-	Setting remains unchanged
	IFX	IFX1...5	-	-	Setting remains unchanged
		MIXER	Pan: #8	-	-
S (Send)1/2			-	-	Setting remains unchanged
Other IFX parameters					Setting remains unchanged
S-MFX	SETUP	MFX1	-	-	Stereo Chorus
		MFX2	-	-	Reverb Smooth Hall
		Chain	-	-	Off
		Level	-	-	127
		Return1	-	-	127
		Return 2	-	-	50

FF/REW Speed

FF/REW Speed is available on all of the tabs under the SEQ, S-INPUT/CTRL, S-LOOP/TONE, S-TRACK, S-ZONE/DELAY, S-MIDI FILTER, S-ARP, S-DRUM TRACK, S-STEP SEQ, S-FX ROUTING, S-IFX, S-MFX pages.

This allows you to set the speed where fast-forward or rewind will occur when you press the FF button or REW button.

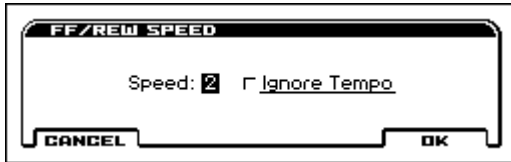

1. In **Speed**, specify the speed (relative to the playback tempo) where fast-forward and rewind will occur.

The Speed setting is in multiples of the playback tempo. A setting of 1 is the same speed as the playback tempo. Settings of 2–4 respectively correspond to double, triple, or quadruple speed of the playback tempo.

Note: Fast-forward and rewind speeds may be slower in regions with dense performance data. Fast-forward and rewind speeds will differ between regions where the performance data is dense or sparse.

2. If **Ignore Tempo** is checked, the playback tempo and note length will be ignored, and fast-forward and rewind occurs.

If this item is **unchecked**, fast-forward and rewind will be performed at the speed you specify for **Speed**.

Set Location (Set Location for Locate Key)

Set Location is available on all of the tabs under the SEQ, S-INPUT/CTRL, S-LOOP/TONE, S-TRACK, S-ZONE/DELAY, S-MIDI FILTER, S-ARP, S-DRUM TRACK, S-STEP SEQ, S-FX ROUTING, S-IFX, S-MFX pages.

When you press the LOCATE button, you will move to the location specified here.



1. In **Location**, specify the location where you will move when you press the LOCATE button.

From the left, the values are Measure (001–999), Beat (01–16), and Tick (000–479).

If you specify **001:01.000**, you will move to the beginning of the song when you press the LOCATE button.

Note: When this dialog box is not open, you can hold down the EXIT button and press the LOCATE button to set the current location as the **Set Location** value.

Detune BPM Adjust

Detune BPM Adjust is available on the Pitch tab of Track Param page.

When the program selected for a track uses a phrase, or rhythm loop multisample, you can use this command to change the BPM of the phrase or rhythm. The BPM can be adjusted by modifying the pitch. This command is available when the **Detune** setting of that track is selected. When you execute this command, the selected **Detune** value will be adjusted.

For more information, please see the “Detune BPM Adjust” section on page 95.

Link From Measure current location

Link From Measure current location is available on S-TRACK EDIT page.

If this check box is selected, the From Measure setting will be linked to the current location, and the location of the displayed track will also change. The location will change to follow this even during playback or recording.

Set Song Length

Set Song Length is available on S-TRACK EDIT page.

This command changes the length of the specified song.

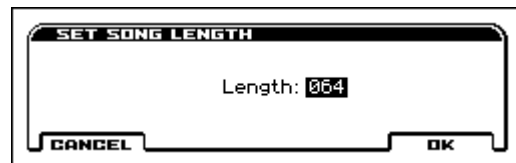

1. In **Length**, specify the length of the song.

⚠ All data following the measure specified by **Length** will be deleted.

Erase Track

Erase Track is available on S-TRACK EDIT page.

This command erases the data from the specified track.

1. In **Track Select**, select the track that you wish to erase.
2. Select “Erase Track” to open the dialog box.

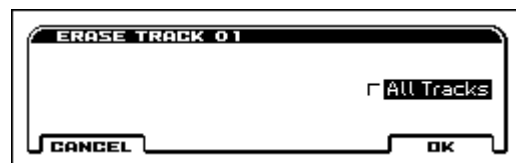

3. Select the track containing the data you want to erase.

If you don’t check **All Tracks**, the data will be erased only from the tracks you specify in **Track Select**.

If you check **All Tracks**, the musical data of all tracks will be erased.

Copy/Bounce Track

Copy/Bounce Track is available on S-TRACK EDIT page.

Copy Track

This command copies musical data from the copy source track to the specified track.

Be aware that the track data of the copy-destination will be erased when you execute the Copy Track operation.

1. Use **Track Select** to select the MIDI track (Track 01–16) that you want to copy.
2. Select “Copy/Bounce Track” to open the dialog box.

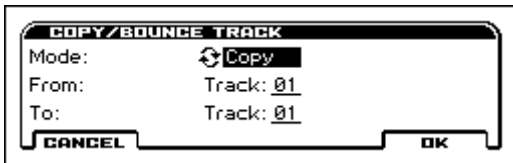

3. Use the “Mode” field to select **Copy**.
4. Use the **From** field to select the copy-source track, and **To** to select the copy-destination.

(By default, the track you choose in **Track Select** will be specified for **From**.)

Bounce Track

This command combines the musical data of the source and destination tracks, and places the combined data in the bounce destination. All musical data in the source track will be erased.

If MIDI control data exists in both the source track and destination track, unexpected results may occur during playback after the bounce command is executed. To prevent this from happening, use **Event Edit** or **Erase Control Data** to edit the MIDI control data of the two tracks before you use Bounce Track.

1. Use **Track Select** to select the MIDI track (Track 01–16) that you want to bounce.
2. Select “Copy/Bounce Track” to open the dialog box.

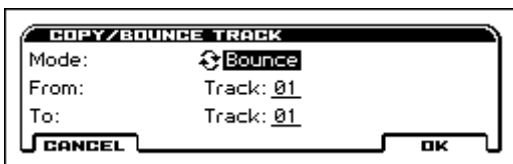

3. Use the “Mode” field to select **Bounce**.
4. Use the **From** field to select the source track, and **To** to select the destination track.

(By default, the track you choose in **Track Select** will be specified for **From**.)

In the case of **Bounce Track**, the source track data will be set to “zero”.

Erase Measure

Erase Measure is available on S-TRACK EDIT page.

This command erases the specified type(s) of musical data from the specified range of measures.

The Erase Measure command can also be used to remove only a specific type of data. Unlike the Delete Measure command, executing the Erase Measure command does not cause the subsequent measures of musical data to be moved forward.

1. Use **Track Select** to select the MIDI track (Track 01–16) that contains the measures of data you want to erase.
2. Select “Erase Measure” to open the dialog box.

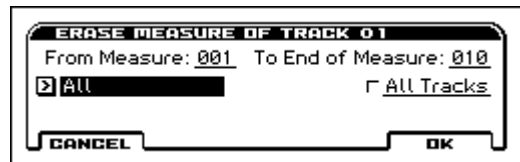

3. In **From Measure** select the first measure to be erased, and in **To End of Measure** select the last measure to be erased.

(By default, **From Measure** and **To End of Measure** will be set to the range that you specified in the **Track Edit** page.)

4. If you are erasing MIDI data, use **Kind** to specify the type of data that will be erased.

All will erase all types of data in that track, **Note** will erase note data, **Control Change** will erase control change data, **After Touch** will erase both channel pressure and poly key pressure data, **Pitch Bend** will erase pitch bend data, **Program Change** will erase program change data, and **Exclusive** will erase exclusive data, **Tempo (for all)** will erase tempo data.

5. Specify the track(s) where you want to execute the command.

If you execute with **All Tracks** unchecked, the command will be executed only on the data of the track you selected in **Track Select**”

If you check **All Tracks**, the command will be executed on the data of all tracks.

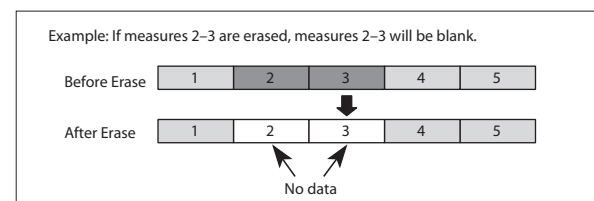

⚠ If control data extends across measures that were erased and measures that were not erased, only the data within the specified range will be removed.

⚠ However if note data extends across two or more measures, deleting any of the intervening measures will delete that note data from the following measures as well.

Note: Note data can also be erased using **Shift/Erase Note**. Use this command when you wish to erase a specific range of notes, or to erase notes from a specific **Beat.Tick**.

Note: Control Change data can also be erased using **Erase Control Data**. Use this when you wish to erase a specific type of control change, or to erase control change data from a specific **Beat.Tick** range.

Delete Measure

Delete Measure is available on S-TRACK EDIT page.

This command deletes the specified measures.

When the Delete Measure command is executed, the musical data following the deleted measures will be moved towards the beginning of the sequence.

1. Use Track Select to select the MIDI track (Track 01–16) that contains the measures you want to delete.
2. Select “Delete Measure” to open the dialog box.

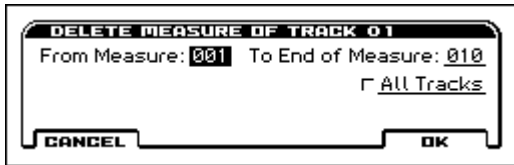

3. In From Measure, select the first measure that you wish to delete, and in To End of Measure, select the last measure that you wish to delete.

(By default, From Measure and To End of Measure will be the range that you specified in the Track Edit page.)

4. Specify the track(s) where you want to execute the command.

If you execute with All Tracks unchecked, the command will be executed only on the data of the track you selected in Track Select.

If you check All Tracks, the command will be executed on the data of all tracks.

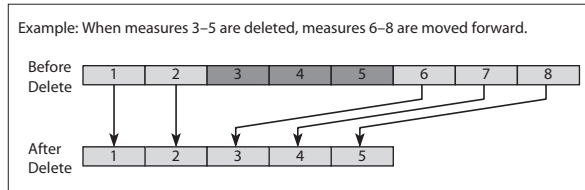

- ⚠ If in step 4 you uncheck All Tracks and execute this operation, the measures will not be deleted from the tempo track. Time signature and tempo data will remain unchanged, and the time signature and tempo of the measures that were moved forward as a result of the Delete operation will change.

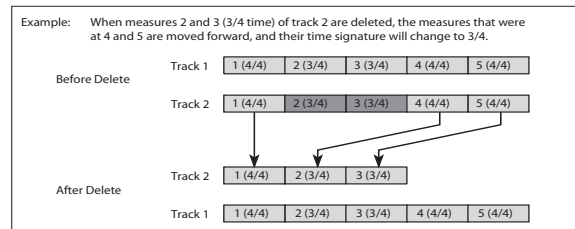

- ⚠ If in step 4 you check All Tracks and execute this operation, the specified measures of musical data will be deleted from all tracks including the tempo track, and the time signature and tempo will also move forward by the number of measures that were deleted.

- ⚠ If control data extends across a line between measures that were deleted and measures that were not deleted, only the data within the range being deleted will be erased.

Insert Measure

Insert Measure is available on S-TRACK EDIT page.

This command inserts the specified number of measures into the specified track.

When you execute the Insert Measure command, the musical data following the insert location will be moved backward.

If you insert measures between note events that are connected by a tie, a note-off will be created immediately before the inserted measure, and the subsequent portion will be deleted.

1. Use Track Select to select the MIDI track (Track 01–16) where you want to insert data.
2. Select “Insert Measure” to open the dialog box.

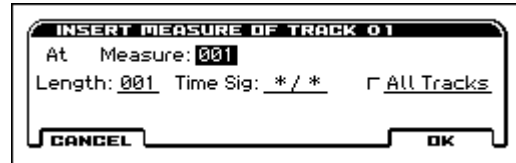

3. In At Measure, specify the measure location where the data will be inserted.

(The measure you specified in the Track Edit page From Measure will be set as a default.)

4. In Length, specify the number of measures that will be inserted.

5. In Meter, specify the Time Sig of the measures that will be inserted.

If you want the inserted measures to match the existing time signature, specify **/**. With any setting other than **/**, the time signature of the inserted measures will change, and the specified time signature will apply to all tracks for those measures.

6. Specify the track(s) where you want to execute the command.

If you execute with All Tracks unchecked, the measures will be inserted into the track that's selected in Track Select. Be aware that at this time, the playback data that follows the insert location will move toward the end of the song according to the number of inserted measures, but the time signature and tempo will not move.

If you check All Tracks, the measures will be inserted into all tracks including the tempo track. The playback data in subsequent measures will play just as it did before this command was executed.

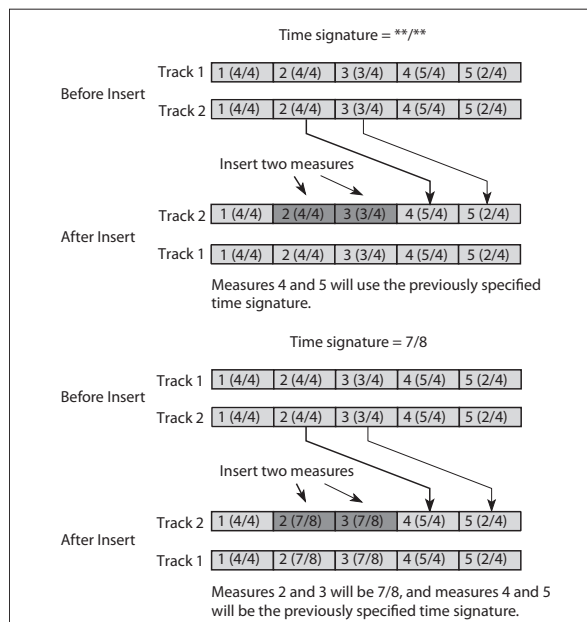

Repeat Measure

Repeat Measure is available on S-TRACK EDIT page.

This command repeatedly inserts the specified measures for the specified number of times.

When you execute the Repeat Measure command, the measures will be inserted following the measure specified by **To End of Measure**, and musical data following the inserted data will be moved backward. It is convenient to use this command when you have a song that you play back with **Track Play Loop** (S-LOOP/TONE> LOOP) turned on, and wish to expand it into musical data.

1. Use **Track Select** to choose the MIDI track (Track 01–16) that you want to insert data into.
2. Select “Repeat Measure” to open the dialog box.

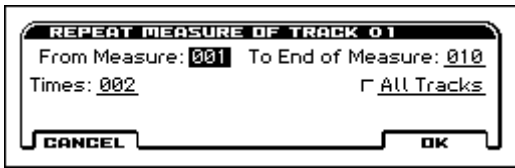

3. In **From Measure** and **To End of Measure**, specify the range of measures that will be repeated.

(By default, **From Measure** and **To End of Measure** will be set to the range you specified in the Track Edit page.)

4. In **Times**, specify the number of repetitions.

For example if you set **From Measure** to 001, **To End of Measure** to 004, and **Times** to 2, the musical data of measures 1–4 will be inserted into measures 5–8. The result will be that measures 1–4 will be played twice.

5. Specify the track(s) where you want to execute the command.

If you execute with **All Tracks** unchecked, the performance data will be inserted into the track you specified in **Track Select**. Be aware that in this case, the performance data following the insert position will move backward (i.e., toward the end of the song) by the number of inserted measures, but the time signature and tempo will not move.

If you execute with **All Tracks** checked, the performance data will be inserted into all tracks, including the tempo track. The performance data following the inserted measures will play back in the same way as it did before.

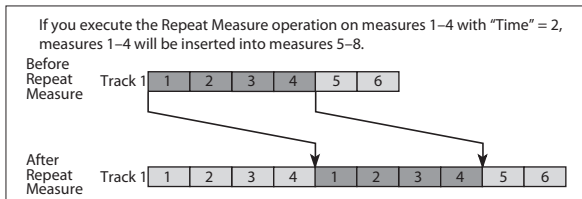

Copy Measure

Copy Measure is available on S-TRACK EDIT page.

This command copies the measures of musical data specified as the **From** source to the beginning of the measure specified as the **To** location.

When you execute the Copy Measure command, the existing track data at the copy destination will be rewritten.

1. Select the copy source song.
2. Select “Copy Measure” to open the dialog box.

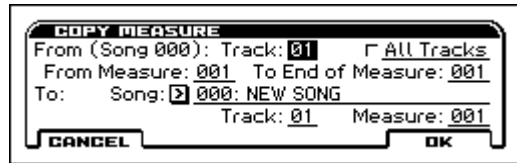

3. In **From: Track** select the copy source track.

(By default, this will be the track you selected in **Track Select**.)

If you execute with **All Tracks** unchecked, only the selected track will be copied. Note that the time signature and tempo will not be copied.

If you check **All Tracks**, the musical data of all tracks including the tempo track will be copied.

4. In **From Measure** and **To End of Measure**, specify the range of copy source measures.

(By default, **From Measure** and **To End of Measure** will be the range that you specified in the Track Edit page.)

5. Use **To: “Song”** to specify the copy-destination song, “Track” (if **All Tracks** is unchecked) to specify the copy-destination track, and **Measure** to specify the starting measure where the copied data will be inserted.

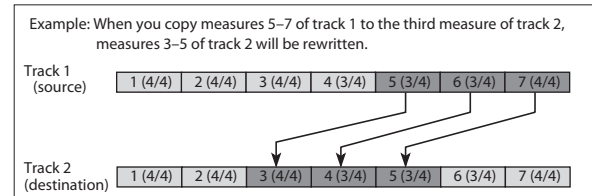

Move Measure

Move Measure is available on S–TRACK EDIT page.

This command moves the specified measures of performance data to another measure.

1. Select “Move Measure” to open the dialog box.

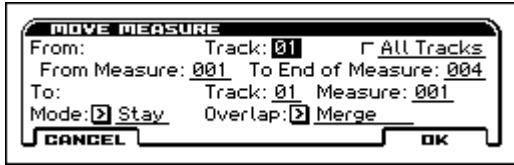

2. In **From: Track** select the move source track.

(By default, this will be the track you selected in **Track Select**.)

If **All Tracks** is unchecked, only data from the selected track will be moved.

If you check **All Tracks**, musical data of all tracks including the tempo track will be moved.

3. In **From Measure** and **To End of Measure**, specify the range of measures that will be moved.

(By default, **From Measure** and **To End of Measure** will be the range that you specified in the **Track Edit** page.)

4. In **To: Track** (if **All Tracks** is unchecked) to specify the move-destination track, and **Measure** to specify the measure where the data will be inserted.

If you execute this with **Mode Stay**, playback data located after the move-source measures and playback data located after the move-destination measures will not move; it will stay where it is.

If you execute this with **Mode Shift**, playback data located after the move-source measures will move toward the beginning of the song by the number of measures that were moved. Playback data located after the move-destination measures will move toward the end of the song by the number of measures that were moved.

5. Set “**Overlap**” to specify what will happen if there is data in the move-destination measures and you’ve specified “**Mode**” **Stay**. If you choose **Merge**, the move-source data and move-destination data will be combined. If you choose **Overwrite**, the move-source data will overwrite (replace) the move-destination data.

Be aware that time signature and tempo data will not be moved.

6. To execute the **Move Measure** command, press the **OK** button. To cancel, press the **Cancel** button.

Example Move measures 3-4 of track 1 to measures 3-4 of track 2.

Mode: Stay

Before Move



After Move Overlap: Merge

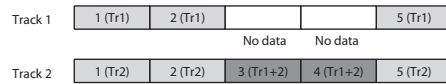

After Move Overlap: Overwrite

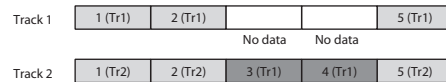

Mode: Shift

Before Move

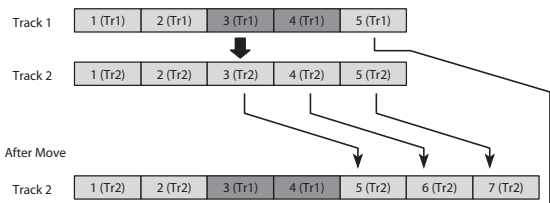

After Move

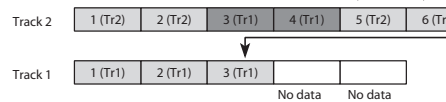

Create/Erase Control Data

Create/Erase Control Data is available on S-TRACK EDIT page.

This lets you create control change, aftertouch, pitch bend, tempo, or other data in the specified region of a MIDI track or the tempo track, or erase such data from the specified region.

Create Control Data

1. In Track Select, select the MIDI track on which you wish to perform the Create Control Data command.
2. Select "Create Ctrl Data" to open the dialog box.



3. Use the "Mode" field to select Create.
4. Specify the range where the control data will be inserted.
In **From Measure** and **To End of Measure**, specify the measures, and in **Beat.Tick**, specify the beat and clock. (By default, **From Measure** and **To End of Measure** will be set to the range you specified in the Track Edit page.)
5. Set "Kind" to the type of musical data (event) that you wish to create.

Control change: Control change data will be inserted. In this case, use # to specify the control change number.

After Touch: Aftertouch data will be inserted.

Pitch Bend: Pitch bend data will be inserted.

Tempo (for all): Tempo data will be inserted (if you've selected the tempo track).

6. In **Start Value**, select the starting value of the control data.
In **End Value**, select the ending value of the control data.

By default, the **Start Value** will be set to the value of the existing data at the start location. If you wish to create control data that changes smoothly from the starting location, you can leave the **Start Value** unchanged, and set only the **End Value**.

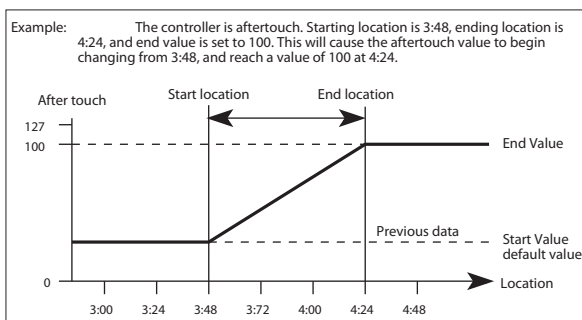

-  When you execute Create Control Data, a large amount of sequencer memory will be consumed. For this reason it may not be possible to execute this command if there is a limited amount of memory remaining. In such cases, first use **Quantize** to quantize the data and remove unnecessary control data. Alternatively, you could quantize the data that was inserted by the Create Control Data command.

Erase Control Data

Erase Control Data is available on all of the tabs of the Track Edit page.

This command erases data such as control changes, after touch, pitch bend, or tempo in the specified range.

1. In Track Select, select the track where you wish to erase control data.
2. Select "Erase Ctrl Data" to open the dialog box.



3. Use the "Mode" field to select Erase.
4. Specify the range where you wish to erase control data.
In **From Measure** to **To End of Measure** specify the measures, and in **Beat.Tick** specify the beat and clock. (By default, **From Measure** and **To End of Measure** will be the range that was specified in the Track Edit page.)
5. Set "Kind" to the type of musical data (event) that you wish to erase.

Control change: Control change data will be erased. In this case, use # to specify the control change number.

After Touch: Aftertouch data will be erased.

Pitch Bend: Pitch bend data will be erased.

Tempo (for all): Tempo data will be erased. (If you've selected the tempo track)

Note: If you wish to erase all control change data from specified measures, you can also use **Erase Measure** and set **Kind** to **Control Change**. However, this **Erase Control Data** command allows you to specify the range using **Beat.Tick**, and also to erase only specific types of control change data.

Quantize

Quantize is available on S-TRACK EDIT page.

This command corrects the timing of MIDI data of the type you specify (note data, control change, aftertouch, pitch bend, program change, etc.) in the track.

When you execute the Quantize operation, the musical data will be affected as follows:

- When you execute Quantize on note data, the timing of the note-on will be corrected, but the length (duration of the note) will not be affected.
- If the Quantize resolution is set to **Hi**, the timing will be adjusted to units of the base resolution (♩/480), so note data will not be affected. However, continuous controller data such as modulation wheel or after touch which occupies a large amount of memory will be processed so that two or more data events of an identical type existing at a single interval of the timing resolution will be combined into a single event, thus conserving memory.

Similarly, two or more identical data events existing at the exact same time will be combined into one, also conserving memory.

1. In **Track Select**, specify the track.
2. Select **"Quantize"** to open the dialog box.

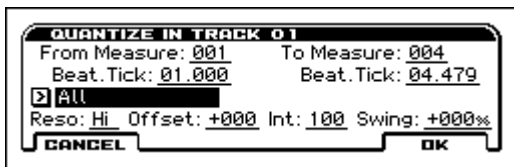

3. Specify the range that will be quantized.

In **From Measure** and **To End of Measure**, specify the measures. In **Beat.Tick** specify the beat and clock. (By default, **From Measure** and **To End of Measure** will be the range that you specified in the Track Edit page.)

4. In **Kind**, select the type of musical data (events) that you wish to quantize.

All: Quantization will be applied to all performance MIDI data.

Note: Quantization will be applied only to note data. Use **Bottom** and **Top** to specify the range of notes. **Bottom** specifies the lowest note that will be affected, and **Top** specifies the highest note. You can use this when you want to quantize only a specific note or notes (for example, just the snare sounds of a drum track). If you want to quantize all notes, set these parameters **C-1** and **G9** respectively.

Control Change: Quantization will be applied to control changes. If you want to quantize only a specific control change, specify the number (**No.**). If you want to quantize all control changes, select **All**.

After Touch: Quantize both Channel Pressure and Polyphonic Key Pressure messages.

Pitch Bend: Pitch bend data will be quantized.

Program Change: Program change data will be quantized.

Tempo (for all): Tempo data will be quantized

5. In **Resolution**, specify the timing resolution to which the data will be corrected.

By setting a lower resolution you can save more memory, but the timing of the playback may not be acceptable.

6. In **Offset**, specify the number of clock ticks by which the data will be moved forward or backward relative to the standard timing.

A setting of **240** will be ♩, and **120** will be ♪. Positive (+) settings will adjust the data forward, and negative (-) settings will adjust the data backward. This allows you to simulate "pushing" or "dragging" the beat.

7. In **Intensity**, specify the degree of sensitivity to which the timing will be corrected; i.e., how close to the locations specified by steps 5 and 6 the data will be moved.

With a setting of **0**, no correction will take place. With a setting of **100**, the data will be moved all the way to the timing intervals specified by steps 5 and 6.

8. Use **Swing** to add a sense of swing to the rhythm. For example, this provides an easy way to give a slight shuffle groove to a "square" 16-beat rhythm.

Settings other than 0% will add a sense of swing by adjusting the position of the notes at even-numbered beats relative to the specified **Resolution**. With a setting of **+100%**, these notes will be moved one third of the way toward intervals of the specified **Resolution**. With a setting of **+300%**, notes of even-numbered beats will be moved all the way to the next even-numbered beat.

- * By varying the **Offset** and **Intensity** settings you can create quantize effects such as the following.

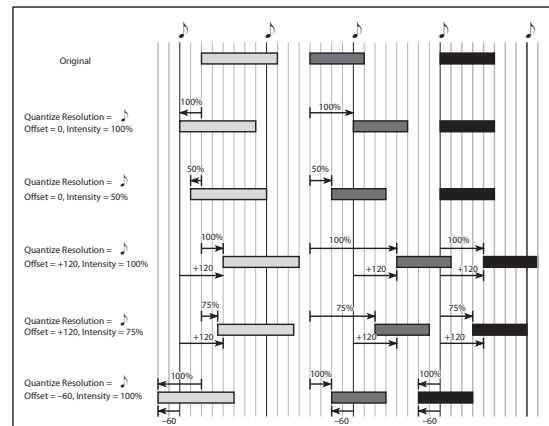

- * By varying the **Swing** settings you can create effects such as the following.

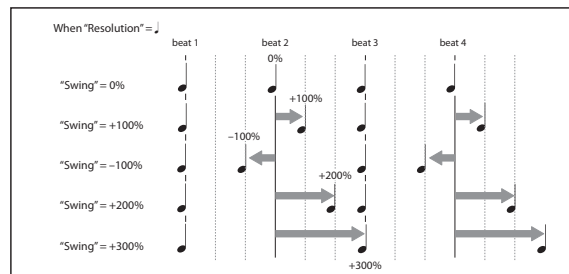

Shift/Erase Note

Shift/Erase Note is available on S-TRACK EDIT page.

This command shifts (moves) or erases specified note numbers in a selected track and over a range of measures.

1. In **Track Select**, choose the MIDI track where you wish to execute the Shift/Erase Note command.
2. Select "Shift/Erase Note" to open the dialog box.

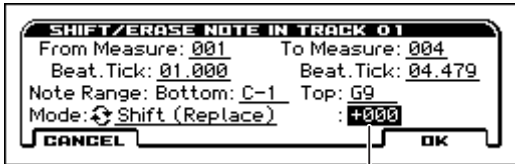

Shift Note

3. Specify the range where you wish to shift or erase note numbers.

In **From Measure** and **To End of Measure**, specify the measures. In **Beat.Tick**, specify the beat and clock. (By default, **From Measure** and **To End of Measure** will be the range that you specified in the Track Edit page.)

4. Specify the range of notes that you wish to shift or erase.

Note Range: Bottom specifies the lower limit, and **Top** specifies the upper limit. If you wish to edit all notes, set **Bottom** to C-1 and **Top** to G9.

• Shifting notes

5. In **Shift Note**, specify the amount by which you wish to move the note.

The amount of shift is set in semitone steps over a range of -127 to +127. +1 will shift the note a semitone upward.

6. Use "Mode" field to select either **Shift (Replace)** to move the note numbers, or **Shift (Create)** to generate additional notes.

For example if you are editing a track that uses a drum program, you can use **Shift (Replace)** to exchange the current snare sound for a different snare sound assigned to a different key, or use **Shift (Create)** to add a sound effect at a different note # to the snare sound. Alternatively, you can use **Shift (Create)** to add an octave doubling to an existing guitar phrase, etc.

• Erasing notes

7. Use the "Mode" field to select Erase.

If you wish to erase all note data in the specified range of measures, you can also use the **Erase Measure** command and set **Kind** to **Note**. However, this Shift/Erase Note command lets you specify the **Beat.Tick** range, and to erase only specific ranges of note data.

Modify Velocity

Modify Velocity is available on S-TRACK EDIT page.

This command modifies the velocity values of notes in the specified area so that they will change over time according to a selected curve.

1. In **Track Select**, specify the track where the velocity will be modified.
2. Select "Modify Velocity" to open the dialog box.

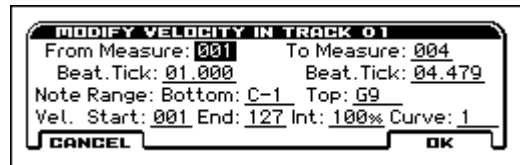

3. Specify the range where note velocity will be modified.

From Measure and **To End of Measure** specify the measure, and **Beat.Tick** specify the beat and clock. (By default, **From Measure** and **To End of Measure** will be set to the range that you specified in the Track Edit page.)

4. Specify the range of notes that will be affected by the **Modify Velocity** command.

Note Range: Bottom is the lower limit, and **Top** is the upper limit. If you wish to edit all notes, set **Bottom** to C-1 and **Top** to G9.

5. In **Vel. Start Value**, specify the value where the velocity data will start, and in **End Value**, specify the final velocity value.

6. In **Intensity**, specify the degree to which the velocity data will be adjusted toward the curve you specify in step 7.

With a setting of 0 [%], the velocity will not change. With a setting of 100 [%], the velocity will be exactly as described by the curve.

7. **Curve** lets you select from six types of curve to specify how the velocity will change over time.

* The six curves are as follows.

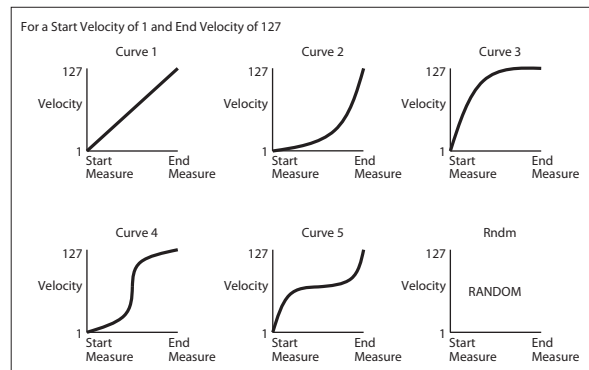

Event Edit

Event Edit is available on S-TRACK EDIT page.

Here you can edit individual events of MIDI data that were input.

1. Use **Track Select** to select the track that you wish to edit, and use **From Measure** field to specify the measure where you wish to begin editing.

If you selected **Track 01-16** in **Event Edit**, selecting this command will open the Set Event Filters dialog box.

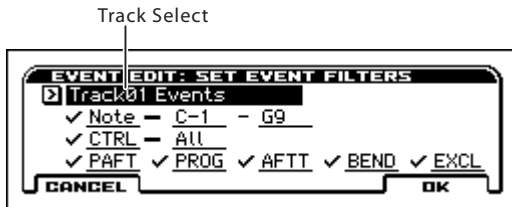

In the **Set Event Filters** dialog box you can select the track and types of events (musical data) that will appear and can be edited in the event edit window.

Track Select selects the track that will be edited. By default, the track selected by S-TRACK EDIT will be selected, but you are free to select a different track. If you want to edit the tempo track, choose **Tempo** (for All Tracks) here.

For **Note** you can set **Bottom** and **Top** to specify the range of notes available for editing. Normally you will leave these set at **C-1** and **G9**.

CTRL (Control Change) lets you specify the control change number. Normally you will leave this set at **All**.

You can also check various other events (**BEND (itch Bend)**, **PROG (Program Change)**, **AFTT (After Touch)**, **PAFT (Poly After Touch)**, and **EXCL (Exclusive)**).

2. Press the **OK** button to open the Event Edit dialog box.

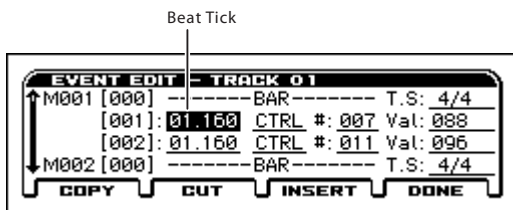

3. In the upper part of the dialog box, **Measure** and **Index** show the measure that you are editing and the events of the index numbers within the measure.

- By modifying the value of the **Beat Tick** location within the measure, you can move the event within the measure.
- You can edit each event by modifying its data value(s). When you select a note event, it will sound.

4. Select the event that you wish to edit, and use the **VALUE controller etc.** to modify its value(s).

• Inserting an event

Select the location **Beat Tick** where you wish to insert an event, and press the **Insert** button to insert an event.

• Deleting an event

Select the event that you wish to delete, and press the **Cut** button to delete the event.

• Moving an event

You can use the **Cut** button and **Insert** button to move an event (as in "cut and paste").

Use the **Cut** button to delete the event that you wish to move, then use the **Insert** button to insert it at the desired location.

You can also move an event by modifying its **Beat Tick** value.

• Copying an event

Select the event that you wish to copy, and press the **Copy** button. Then select the copy destination and press the **Insert** button to insert the event at that location.

5. When you are finished editing events, press the **Done** button.

By selecting the **UNDO** function you can return to the state prior to event editing.

The following table shows the types of musical data that can be edited by **Event Edit** and the range of their values.

BAR (displayed only) (Measure line)		TS (Time Signature): 1/ 4...16/16 *1
C-1...G9 *2 (Note data)	V: 1...127 *2 (Velocity)	L: 000.000...15984.000 (Length: beats, clocks)
PAFT (Polyphonic after touch)	C-1...G9 (Note number)	0...127 (Value)
CTRL (Control change)	C: 0...119 (Control change number)	0...127 (Value)
PROG (Program change)	Bank:A...E 000...127, GM, g(1)...g(9) g(d), ---, (Program bank)	P: 0...127, 1...128 (GM, g(1)...g(d)) (Program number)
AFTT (After Touch)	0...127 (value)	
BEND (Pitch bend)	-8192...+8191 (value)	
EXCL *3 (Exclusive)		
Tempo (for All Tracks) *1	Tempo: 040...300	TS (Time Signature): 1/4...16/16 *1

*1: Be aware that because the time signature is recorded in the tempo track, modifying it within any track will affect all tracks at the same measure, causing them all to play back with the modified time signature.

Note: *2: You can also enter the note data and velocity values by holding down the **ENTER** button and playing a key.

*3: You cannot change Exclusive events into a different type of event (e.g., a Note or Control Change event). Nor can you change any other type of event into an Exclusive event.

Rename Track

Rename Track is available on S-TRACK EDIT page.

Here you can rename the tracks.

For more information, please see "Editing names" on page 105 of the Operation Guide.

Copy Arpeggiator

Copy Arpeggiator is available on the SEQ> ARP tab and S-ARP pages.

This function can copy arpeggiator settings from another location to the current song.

For more information, please see the "Copy Arpeggiator" section on page 65.

Copy Drum Track

Copy Drum Track is available on the S-DRUM TRACK pages.

This function copies the drum track settings of the specified Program, Combination, or Song.

For more information, please see the "Copy Drum Track" section on page 64.

Assign inst to Tone

Assign inst to Tone is available on the S-STEP SEQ pages.

Here's how to assign an instrument to each tone of the step sequencer. This function is the same as in Program mode.

For more information, please see the "Assign inst to Tone" section on page 65.

Edits Step Parameters

Edit Step Seq is available on the S-STEP SEQ pages.

Here you can specify velocity and accent on/off for each step. This function is the same as in Program mode.

For more information, please see the "Edits Step Parameters" section on page 65.

Copy Step Seq

Copy Step Seq is available on the S-STEP SEQ pages.

This function copies the step sequencer settings from the program, combination, or song that you specify. This function is the same as in Program mode.

For more information, please see the "Copy Step Seq" section on page 65.

Copy Insert Effect

Copy Insert Effect is available on all of the S-FX ROUTING and S-IFX pages.

For more information, please see the "Copy Insert Effect" section on page 66.

However, the MIDI control channel specified in **Ctrl Ch** of the IFX 1-5 page will not be copied.

Swap Insert Effect

Swap Insert Effect is available on all of the S-FX ROUTING and S-IFX pages.

For more information, please see the "Swap Insert Effect" section on page 66.

However, the MIDI control channel specified in **Ctrl Ch** of the IFX 1-5 page will not be swapped.

DKit IFX Patch

This patches the **Bus Select** settings for each key of a drum kit, temporarily changing the insert effect connection destinations.

You can execute this function if the program assigned to the track is a drum program and **Bus Select** is set to **DKit**.

For more information, please see the "DKit IFX Patch" section on page 96.

Copy Master Effect

Copy MFX is available on all of the S-MFX pages.

For more information, please see the "Copy Master Effect" section on page 66.

However, the MIDI control channel specified in **Ctrl Ch** of the S-MFX> MFX 1, MFX2 page will not be copied.

System Exclusive events supported in Sequencer mode

You can record and play back System Exclusive events, and edit tracks that contain System Exclusive events.

SysEx messages that can be recorded in real-time

The following exclusive messages can be recorded in real-time:

- Exclusive messages received from an external MIDI device
- Parameter changes in Sequencer mode (see table below)
- Master Volume universal exclusive messages assigned to the foot pedal

Parameter change messages that you can realtime-record in Sequencer mode

Front panel/Page	Parameter	
Front panel	ARP	ARP button
	DRUM TRACK	DRUM TRACK button
SEQ	PROG, MIX	Program Select, Pan, Volume, PLAY/MUTE, Solo On/Off ^{*1}
	ARP	[GATE], [VELOCITY], [SWING]
S-INPUT/CTRL	CONTROLLERS	All "SW1," "SW2" parameters
S-LOOP/TONE	TONE ADJ, TONE EG	All "Tone Adjust," "EG Adjust" parameters
S-TRACK	OSC	Force OSC Mode, OSC Select, Portamento
	PITCH	Transpose, Detune, Bend Range
	SCALE	Use Program's scale, Type, key, Random
S-ZONE/DELAY	DELAY	Delay Time [ms], MIDI/Tempo Sync., Base Note, Times
S-ARP	ASSIGN	All parameters
	A, B	All parameters
	SCAN ZONE	All parameters
S-DRUM TRACK	PATTERN, CHANNEL	All "Drum Track" parameters
S-STEP SEQ	BASIC, EDIT, INST, MOD	All step sequencer parameters other than STEP, ZONE, and STATUS (RUN/STOP).
S-IFX	BUS, SEND	Bus Select, Send1, Send2, Fx Control Bus
	Insert FX Setup	IFX, Effect On/Off, Chain to, Chain, Pan, Bus Sel, FX Control Bus, Send1, Send2
	IFX 1-5	All effect parameters
	Common FX LFO	All "Common FX LFO 1, 2" parameters
S-MFX	SETUP	MFX, Effect On/Off, Chain, Chain Direction, Chain Level, Return 1, Return 2
	MFX 1/2	All effect parameters

*1: **Solo On/Off** is always controlled by events in the track, regardless of the play/mute status of that track.



The maximum amount of exclusive data that can be recorded at once is approximately 320 Kbytes. This size will decrease if other events exist within the same measure.



You cannot simultaneously record exclusive messages received from an external MIDI device and parameter changes produced by editing.



The events that will be recorded are controlled by the G-MIDI> OUT settings SEQ Mode **Param. MIDI Out**. For Control Change, only control change messages will be recorded. For SysEX-Param Change, only parameter changes and exclusive messages will be recorded (see "Param. MIDI Out" on page 161).



Realtime recording will not record parameter edits that you perform by executing functions in the various pages, nor changes you make by using the Effect Preset function to recall effect parameters.

KROSS sequencer file formats

The KROSS sequencer supports both the proprietary KROSS Song format, and Standard MIDI Files.

If you like, you can convert data between the two formats, simply by loading the data in one format and then saving it in the other.

For details, please see “18) Load Standard MIDI File” on page 182, and “Save SEQ” on page 184.

KROSS Song format

This is the native KROSS sequencer format, which is required to ensure that all KROSS-specific data is saved correctly.

Song data saved in the dedicated format of the Korg microSTATION

.SNG files saved by the Korg microSTATION can be converted into KROSS format as they are loaded.

(see “File compatibility with the microSTATION” on page 308)

Standard MIDI Files

You can also load and save Standard MIDI Files (SMF), for compatibility with other sequencers. Note that some KROSS-specific data may not be maintained when in SMF files.

GM, XG, and GS System Exclusive Data

The KROSS sequencer can record System Exclusive messages, including XG or GS data. For details, please see “System Exclusive events supported in Sequencer mode” on page 152.



Note that GM, XG, and GS exclusive messages do not affect the KROSS when they are played back.

Global/Media mode

In Global mode, you can adjust settings that affect the entire instrument, such as master tuning, MIDI, and memory protect.

You can also edit user scales, drum kits, and user arpeggio pattern setups.

 If you want the settings you change in Global mode to be backed up when the power is turned off, you must write them into memory. From DRUM KIT page, you'll be able to select the function **Write Drum Kits**. From ARP PATTERN page, you'll be able to select **Write Arpeggio Patterns**. From the other pages of Global mode, you'll be able to select **Write Global Setting**.

In media mode, you can save internal memory data to an inserted SD card, or load data from media into internal memory. You can also copy or delete files, or format media.

Global/Media Page Select

Here's how you can select each page.

- Use the PAGE+/- buttons.
- To move directly to Media mode, hold down the EXIT button and press the GLOBAL/MEDIA button.
- Press the MENU button to access the page menu, use the PAGE+/- buttons to select a page, and press the MENU (OK) button or the ENTER button.
- While the above page menu is displayed, press the FUNCTION (TABS) button, then use the PAGE+/- buttons to select a page by its tab, and then press the MENU (OK) button or the ENTER button.

For details, see “Selecting pages and tabs” section on page 11 of the Operation Guide.



Page	Tab	Main content
GLOBAL	BASIC	Settings such as master tuning, transpose, and velocity curve (see page 156)
	SYSTEM	Settings such as effects, arpeggiator, step sequencer and Drum Track on/off, and memory protect (see page 157)
	PREF	Settings such as auto power-off and battery type (see page 158)
G-MIDI	BASIC	MIDI settings for the entire KROSS (see page 159)
	OUT	MIDI settings for the sequencer and production tools (see page 161)
	FILTER	MIDI filter settings (see page 162)
G-INPUT/ CTRL	AUDIO IN	External audio input settings (see page 163)
	FOOT	Foot controller function assignments (see page 164)
G-USER SCALE	CC	MIDI output settings for arpeggiator control (see page 165)
	OCTAVE	Creating user scales (see page 165)
ALL		
ARP PATTERN	SETUP	Creating user arpeggios (see page 167)
	EDIT	
	MODE	
DRUM KIT	DS 1, 2, 3, 4	Creating user drum kits (see page 170)
	VOICE	
MEDIA	FILE	Saving and loading data (see page 175)
	UTILITY	Deleting files, formatting an SD card (see page 175)
	INFO	SD card information (see page 175)

Global mode

0: GLOBAL

0-1: BASIC

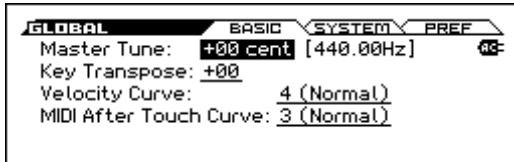

Master Tune [-50cent (427.47Hz)...+50cent (452.89Hz)]

This adjusts the overall tuning of the entire KROSS in one-cent units (semitone = 100 cents), over a range of ±50 cents. With a setting of 0, the frequency of A4 will be 440 Hz.

The A4 pitch given here is when Equal Temperament is selected as the scale. If a different scale is selected, A4 may not be 440 Hz.

Key Transpose [-12...+00...+12]

This adjusts the pitch in semitone steps over a ±1 octave range.

This setting is applied at the location (PreMIDI or PostMIDI) specified by **Convert Position** (G-MIDI> BASIC).

MIDI note number transmitted by the KROSS

Keys\Transpose	-12	0	+12
61 keys	24...84 (C1...C6)	36...96 (C2...C7)	48...108 (C3...C8)
88 keys	9...96 (A-1...C7)	21...108 (A0...C8)	33...120 (A1...C9)

Note: If **Convert Position** is set to PreMIDI, the MIDI note numbers transmitted from the KROSS will be affected by the **Key Transpose** setting.

Master Tune can be controlled by the MIDI universal System Exclusive message Master Fine Tuning (F0, 7F, nn, 04, 03, vv, mm, F7: nn=MIDI channel, vv/mm=value). **Key Transpose** can be controlled by the MIDI universal System Exclusive message Master Coarse Tuning (F0, 7F, nn, 04, 04, vv, mm, F7: nn=MIDI channel, vv/mm=value). These messages are received on the global MIDI channel specified by **MIDI Channel** (G-MIDI> BASIC).

In Program, Combination, and Sequencer modes, MIDI RPN messages can be received to control the tuning and transposition of the program or timbre (Combination mode) or track (Sequencer mode). Incoming MIDI RPN Fine Tune messages will make relative adjustments to the tuning specified by the **Master Tune** setting.

MIDI RPN Coarse Tune messages will make relative adjustments to the pitch specified by the **Key Transpose** setting. In Program mode, these messages will be received on the global MIDI channel specified by **MIDI Channel** (G-MIDI> BASIC), and in other modes they will be received on the MIDI channel specified for each timbre or track. (**Transpose, Detune, C-TIMBRE> PITCH, S-TRACK> PITCH**)

Velocity Curve [1...9]

This specifies the way that the volume and/or tone will change in response to variations in keyboard playing dynamics (velocity).

The curves you can select will depend on the **Convert Position** (G-MIDI> BASIC) setting. If the setting is PreMIDI, the curve is applied immediately after the keyboard. If the setting is PostMIDI, the curve is applied immediately before the sound generator.

In the case of PreMIDI, your keyboard playing dynamics are modified as shown by transmission curves 1-9 (lower left diagram), and reception is fixed at curve 4 linear (diagram at lower right).

In the case of PostMIDI, your keyboard playing dynamics are transmitted according to transmission curve 4 linear (lower left diagram), and will be interpreted according to reception curve 1-9 (lower right diagram).

If you're using the KROSS as a MIDI sound module, and want to adjust the overall brightness of the sound, set **Convert Position** (G-MIDI> BASIC) to PostMIDI and select the appropriate velocity curve.

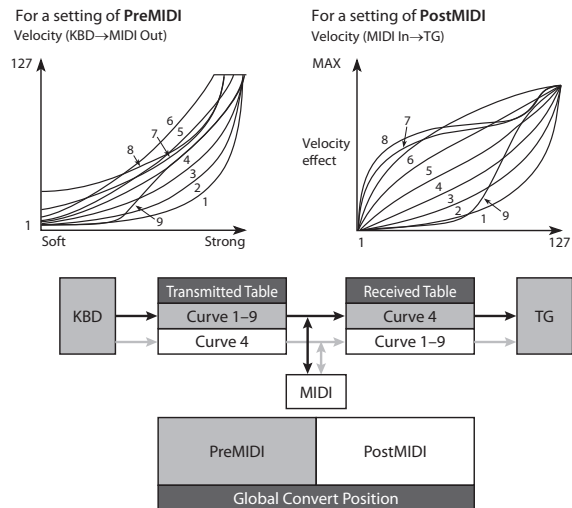

1, 2, 3: Strongly played notes will be affected.

4 (Normal): The normal curve

5, 6: Produces an effect even if you do not play very strongly.

7: This curve produces a relatively consistent effect for softly played notes.

8: This curve produces an even more consistent effect.

Each curve has its own characteristics, so you should select the curve that best suits your own playing style and the results you want to obtain.

9: Compared with the standard curve #4, this curve softens the response of gently-played notes. This allows velocity control with broader dynamics for sounds such as acoustic piano. This setting is particularly recommended for the KROSS-88.

MIDI After Touch Curve [1...8]

This specifies the way that incoming aftertouch data will affect the volume or tone when **Convert Position** (G-MIDI> BASIC) is set to PostMIDI.

This curve is applied immediately before the tone generator. The **aftertouch Curve** setting selects the curve that is applied to the incoming aftertouch.

This setting has no effect when **Convert Position** (G-MIDI> BASIC) is set to PreMIDI.

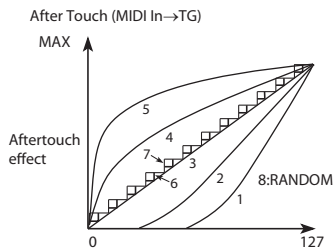

1, 2: This curve produces change when strong aftertouch pressure is applied.

3 (Normal): The normal curve.

4, 5: This curve produces change even when light pressure is applied.

6, 7: These curves produce change in 24 or 12 steps. Curve number 7 allows change over twelve steps, so when using aftertouch to modify the pitch, you can set the range of modification to one octave, and use aftertouch to vary the pitch in semitone steps.

8: This is a random curve. Use this when you wish to create special effects, or to use aftertouch to apply unpredictable modulation.

0-2: SYSTEM

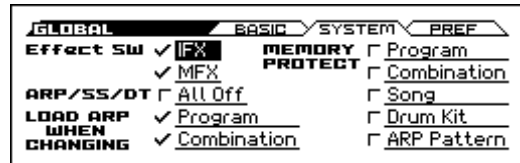

Effect SW

IFX

[Off, On]

On (checked): The FX ROUTING-IFX settings for each Effect On/Off in Program, Combination, and Sequencer modes will be valid.

Off (unchecked): All insert effects IFX1-5 will be off.

MFX

[Off, On]

On (checked): The MFX-SETUP settings for each Effect On/Off in Program, Combination, and Sequencer modes will be valid.

Off (unchecked): Master Effect1 and 2 (MFX1, 2) will be off.

This on/off setting is linked with the front panel MASTER FX button.



These settings will always be turned on when you power-on the KROSS.



When IFX or MFX settings are switched, control change messages CC#92 (effect control 2), CC#94 (effect control 4), and CC#95 (effect control 5) will be transmitted respectively. The transmitted data will be 0 for off, and 127 for on.

ARP/SS/DT

All Off

[Off, On]

On (checked): All arpeggiator, Step Sequencer and Drum Track functions will be off. These functions will not run even if the ARP button, RUN button, or DRUM TRACK button respectively are on.

Off (unchecked): The arpeggiator, step sequencer, and Drum Track will function according to the settings of the applicable mode.

LOAD ARP WHEN CHANGING

Program

[Off, On]

On (checked): When you switch programs, the arpeggiator settings stored in that program will be used. Normally you will use the On setting.

Off (unchecked): The arpeggiator settings will not change even if you switch programs. Use this setting if you want to switch Program sounds without changing the phrases from the arpeggiator.

Combination

[Off, On]

On (checked): When you switch combinations, the arpeggiator settings stored in that combination will be used. Normally you will use the On setting.

Off (unchecked): The arpeggiator settings will not change even if you switch combinations. Use this setting if you want only to switch combination sounds without changing the phrases from the arpeggiator.

MEMORY PROTECT

Program [Off, On]

This setting protects the internal program memory.

On (checked): Internal program memory will be protected, and the following write operations cannot be performed.

- Writing a program
- Loading preloaded program data
- Loading program data from media
- Receiving program data via MIDI data dump

Off (unchecked): Data can be written to internal program memory.

Combination [Off, On]

This setting protects the internal combination memory.

On (checked): Internal combination memory will be protected, and the following write operations cannot be performed.

- Writing a combination
- Loading preloaded combination data
- Loading combination data from media
- Receiving combination data via MIDI data dump

Off (unchecked): Data can be written to internal combination memory.

Song [Off, On]

This setting protects the internal song memory.

However, when the power is turned off, the song data in song memory will be lost regardless of this setting.

On (checked): Internal song memory will be protected, and the following write operations cannot be performed.

- Recording to the sequencer
- Loading demo song data
- Loading song data from media
- Receiving song data via MIDI data dump

Off (unchecked): Data can be written to internal song memory.

Drum Kit [Off, On]

This setting protects the internal drum kit memory.

On (checked): Internal drum kit memory will be protected, and the following write operations cannot be performed.

- Writing a drum kit
- Loading preloaded drum kit data
- Loading drum kit data from media
- Receiving drum kit data via MIDI data dump

Off (unchecked): Data can be written to internal drum kit memory.

ARP Pattern [Off, On]

This setting protects the internal user arpeggio pattern memory.

On (checked): Internal user arpeggio pattern memory will be protected, and the following write operations cannot be performed.

- Writing a user arpeggio pattern
- Loading preload arpeggio pattern data
- Loading user arpeggio pattern data from media
- Receiving user arpeggio pattern data via MIDI data dump

Off (unchecked): Data can be written to internal user arpeggio pattern memory.

0-3: PREF (System Preference)

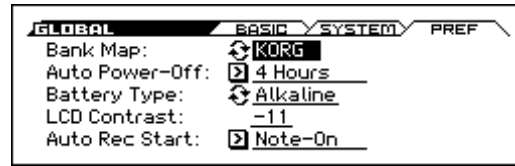

Bank Map [KORG, GM(2)]

This specifies the mapping of programs and combinations relative to Bank Select control change messages (CC#0 upper byte and CC#32 lower byte).

The bank select messages shown in the table below will be received (R) and transmitted (T) for Program banks A–D, U, GM, g(1)...g(9), g(d) and Combination banks A, B, U.

Prog Bank	Combi Bank	Bank Map: KORG	Map: GM(2)
A	A	00.00 R/T	63.00 R/T
B	B	00.01 R/T	63.01 R/T
C	U	00.02 R/T	63.02 R/T
D		00.03 R/T	63.03 R/T
U		00.04 R/T	63.04 R/T
GM,		121.00 R/T, 56.00 R	121.00 R/T, 56.00 R, 00.00 R
g(1)...g(9)		121.01...09 R/T	121.01...09 R/T
g(d)		120.00 R/T, 62.00 R	120.00 R/T, 62.00 R

Auto Power-Off [30 minutes, an hour, 4 hours, Disabled]

The KROSS will automatically turn off its own power a certain length of time after its keyboard, buttons, or dial were last used. (With the factory settings, the power will turn off in approximately four hours.)

* Moving the VOLUME knob is not considered usage for this purpose. Even if you use this knob, the power will still turn off when the specified time has elapsed if no other user input has been performed.

Even when songs or demo songs are being played back consecutively, the power will automatically turn off if the specified time elapses without any sound at all being produced.

Here you can specify the time when auto power-off will occur. You can also prevent the power from turning off.

 When the power turns off, the settings you had been editing will be lost. You should save any settings that you want to keep.

30 minutes, an hour, 4 hours: The power will automatically turn off if the specified time elapses without any user input being performed on the KROSS's keyboard or buttons. The available settings are 30 minutes, 1 hour, and 4 hours.

If you've chosen one of these settings, a dialog box will appear when the system starts up, informing you of the length of time after which auto power-off will occur.

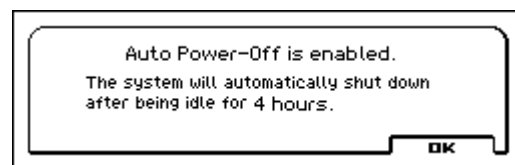

Several minutes before the power turns off, a dialog box will appear with a count-down indicating the time until the power turns off. If you don't want the power to turn off, press the KROSS's display or keyboard, or use a button or knob. Auto power-off will be reset, and the same message will appear once again if no user input is performed for the specified length of time.

The system has been idle for more than 4 hours,
and will shut down in: 00:01
You can change the Auto Power-Off setting
on the following page: GLOBAL - PREF

Disable: Auto power-off will be disabled. The power will not turn off automatically.

Battery Type [Alkaline, Ni-MH]

After you've installed the batteries, turn on the power and specify the type of batteries you're using.

Alkaline: Alkaline batteries: Alkaline

Ni-MH: Nickel-metal hydride batteries: Ni-MH

LCD Contrast [-64...+63]



This adjusts the contrast of the display.

 Changes to this setting are always saved. You don't need to execute Write Global Setting.



Auto Rec Start [Off, Note-On, SEQ START, Input Low, Input High]

Specifies how recording on the audio recorder will start.

This is linked with the Auto parameter of the AUDIO RECORDER SETUP dialog box.

Off: From the record-standby state, press the Rec Control  (MENU) button or the AUDIO RECORDER  /  button to start recording.

Note-On: Recording will start when you play the keyboard from the record-standby state.

SEQ START: Recording will start when you press the SEQUENCER PLAY/STOP ( / ) button from the record-standby state.

Input Low: Recording will start when the audio input level exceeds approximately -18 dB while in the record-standby state.

Input High: Recording will start when the audio input level exceeds approximately -6 dB while in the record-standby state.

 Changes to this setting are always saved. You don't need to execute Write Global Setting.

✓ 0-1...3: FUNCTION

- 0: **Write Global Setting** see page 176
- 1: **Load Preload/Demo Data** see page 176
- 2: **Change all bank references** see page 176
- 3: **Half Damper Calibration** see page 176
- 4: **Update System Software** see page 177

For more information, please see the "Global, Media: FUNCTION" section on page 176.

1: G-MIDI

1-1: BASIC (MIDI Basic)



Here you can adjust MIDI-related settings that affect the entire KROSS.

Note: To transmit a MIDI exclusive dump data, you'll use the functions of this G-MIDI page.

MIDI Channel (Global MIDI Channel) [1...16]

Sets the global MIDI channel.

The global MIDI channel is used in the following cases.

- When transmitting and receiving performance data in Program mode (PROG> MAIN).
- When selecting combinations via MIDI in Combination mode (COMBI> MAIN).
- When triggering the drum track (with **Trigger Mode** set to Wait KBD Trig) in Program or Combination mode.
- When controlling timbres or effects that have been set to Gch in various modes
- When transmitting and receiving System Exclusive messages

MIDI received

In Program mode (PROG> MAIN), MIDI data is received on the global MIDI channel, but in Combination mode (COMBI> MAIN) or Sequencer mode, MIDI data is received on the MIDI channel specified for each timbre or track.

In Combination mode (COMBI> MAIN), program changes received on the global MIDI channel will switch the combination (G-MIDI> FILTER).

Use the global MIDI channel to switch IFX 1-5 (CC#92) and MFX1&2 (CC#94) on/off.

To control the pan, sends 1/2 following IFX and MFX, use the global MIDI channel when in the Program mode; while in the Combination, or Sequencer modes, use the channel specified separately by **Ch (Control Channel)** for IFX1-5 and MFX1&2. By setting **Ch (Control Channel)** to Gch, you can control these parameters from the global MIDI channel.

MIDI output when playing the KROSS

In Program mode, this data will be transmitted on the global MIDI channel. In Combination mode, data will be transmitted simultaneously on the global MIDI channel and on the MIDI channels of timbres whose **Status** (COMBI> PROG) is set to EXT or EX2.

In Sequencer mode, musical data will be transmitted on the channel specified for the currently selected track (whose **Status** is BTH, EXT, or EX2).

Note Receive (Note Receive Filter) [All, Even, Odd]

This setting specifies whether even-numbered, odd-numbered, or all note numbers will be sounded when note data is received from the KROSS's keyboard or from an external MIDI device. By connecting the KROSS to another KROSS and setting one instrument to Even and the other to Odd, you can effectively double the polyphony by dividing the notes between the two instruments.

All: All note numbers will be received. Normally you will leave this set to All.

Even: Even-numbered notes (C, D, E, F#, G#, A#) will sound.

Odd: Odd-numbered notes (C#, D#, F, G, A, B) will sound.

MIDI This setting has no effect on the MIDI data that is received.

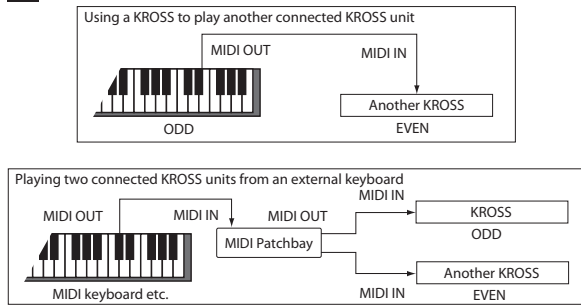

Convert Position

[PreMIDI, PostMIDI]

This setting specifies the location where the Transpose and Velocity Curve settings will be applied. This setting will affect the MIDI data that is transmitted and received, and the data that is recorded on the internal sequencer.

When using the KROSS's keyboard to play the internal tone generator, the Transpose, Velocity Curve, and aftertouch Curve settings will always take effect regardless of this setting.

PreMIDI: Velocity Curve, and Transpose will be applied to the data that is transmitted from the KROSS's keyboard.

This means that the Velocity Curve, and Transpose settings will affect the data that is transmitted from MIDI OUT when the KROSS's keyboard is played, and the data that is recorded on the internal sequencer.

MIDI data received from MIDI IN or the data played back by the internal sequencer will not be affected.

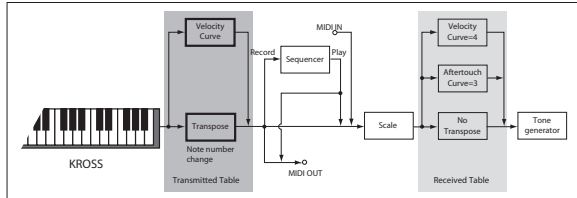

PostMIDI: Velocity Curve, aftertouch Curve, and Transpose will be applied to data before it enters the tone generator.

This means that the Velocity Curve, aftertouch Curve, and Transpose settings will affect the data that is sent to the internal tone generator when you play the KROSS's keyboard, when the internal sequencer is played back, or when data is received from MIDI IN.

This setting will not affect the data that is transmitted from MIDI OUT or recorded on the internal sequencer when you play the KROSS's keyboard or play back the sequence.

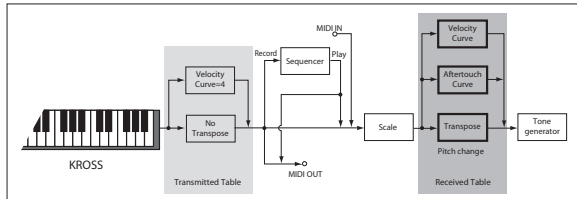

Local Control On

[Off, On]

Local Control On (checked): The KROSS's keyboard, pitch bend wheel, modulation wheel, SW1, and SW2 will control the KROSS's sound generator. Leave this setting checked if you're playing the KROSS by itself.

Local Control Off (unchecked): The KROSS's keyboard, pitch bend wheel, modulation wheel, SW1, and SW2 will be disconnected from the KROSS's sound generator.

This means that using the KROSS (playing its keyboard and using the wheels, or playing back the sequencer) will not sound its internal tone generator.

Turn **Local Control** Off if loop-back from an external sequencer causes duplicate notes.

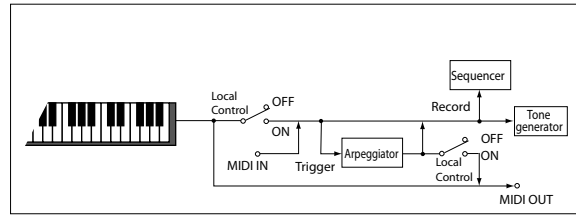

MIDI If **Local Control** is Off, MIDI transmission/reception will occur normally. Playing the keyboard will cause the corresponding note data to be transmitted, and received note data will play the KROSS's internal sounds.

Note: Even if Local Control is On, notes played back by the internal sequencer will not trigger the arpeggiator.

MIDI Clock (MIDI Clock Source)

[Internal, Ext-MIDI, Ext-USB, Auto]

Select this setting when you want to synchronize the following functions of the KROSS with an external MIDI device (such as a sequencer or rhythm machine) or computer.

- arpeggiator
- drum track
- step sequencer
- internal sequencer

Internal: The functions listed above will operate using the internal clock.

Select the Internal setting when using the KROSS by itself, or when you want the KROSS to be the master (controlling device) so that connected external MIDI devices will synchronize to the KROSS MIDI Clock.

Ext-MIDI: The arpeggiator and internal sequencer will operate in synchronization to the MIDI Clock input from an external MIDI device.

Ext-USB: The arpeggiator and internal sequencer will operate in synchronization with the MIDI Clock from a computer (for example a sequencer or DAW application), connected to the USB connector.

Auto: Normally the operation will be the same as the Internal setting. If external MIDI Clock messages are received from the MIDI IN or USB connector, the KROSS will automatically switch to Ext-MIDI and Ext-USB.

Note: If you select Auto when an external MIDI sequencer and computer is connected, the KROSS will automatically switch to Internal operation if the external sequencer is not transmitting MIDI Clock messages, allowing the arpeggiator to operate and parameters where MIDI/Tempo Sync is turned on to function.

Note: If after receiving a MIDI Clock, Start, or Continue message from the MIDI IN or USB connector, no new MIDI Clock message is received within an interval of 500 ms, or if you start the KROSS's sequencer from the front panel without having received a MIDI Clock, Start, or Continue message from the MIDI IN and USB connector, the KROSS will automatically switch to Internal operation.

Receive Ext. RT Cmd (Receive Ext. Realtime Commands)

[Off, On]

Off (unchecked): Even if **MIDI Clock** is set to Ext-MIDI, or if set to Auto and the KROSS is synchronized to external MIDI Clock messages, MIDI Common messages and Realtime messages (Song Position Pointer, Start, Continue, Stop) will not be received. (Song Select messages will be received.)

Note: Use this setting if the above messages from an external MIDI sequencer are inadvertently resetting the KROSS's song settings.

On (checked): The above Common messages (including Song Select) and Realtime messages will be received.

 This parameter cannot be set if **MIDI Clock** is set to Internal.

1-2: OUT

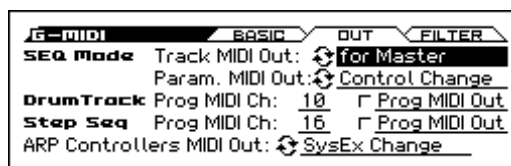

SEQ Mode

Track MIDI Out [for Master, for External Sequencer]

This setting specifies what will be transmitted via MIDI when you switch songs in Sequencer mode.

for Master: Normally in Sequencer mode, the internal sequencer can record or play back a performance on the KROSS's keyboard. In this case, tracks that are set to EXT or BTH will control external MIDI sound modules. You can create settings in a song so that when you select that song on the KROSS, tracks that are set to EXT or BTH will transmit program changes or other MIDI messages* to set up your external MIDI sound modules.

for External Sequencer: Choose this setting if you want to use the KROSS in Sequencer mode as a multi-timbral sound module driven by an external sequencer. With this setting, even the tracks that are set to EXT or BTH will not transmit program changes or other MIDI messages* when you switch songs on the KROSS. In this case, echo-back from the external MIDI sequencer will not switch programs or other parameters to the identical settings on each track that is set to the same MIDI channel.

* Applicable parameters

- Program Select: CC#00 bank select (LSB), CC#32 bank select (MSB), program change
- Pan: CC#10 pan
- Volume: CC#7 volume
- Portamento: CC#65 portamento On/Off, CC#5 portamento time
- Send 1/2: CC#93 send 1 level, CC#91 send 2 level
- (Post FX) Pan: CC#8 post insert effect pan

Param. MIDI Out [Control Change, SysEx-Param Change]

This setting specifies whether control changes or System Exclusive messages will be transmitted when you edit a parameter in Sequencer mode.

Control Change: Data for the edited parameter will be transmitted as a control change.

SysEx-Param Change: Data for the edited parameter will be transmitted as a parameter change.

Note: For these functions, **Enable Control Change** or **Enable Exclusive** (G-MIDI> FILTER) must be checked respectively.

* Applicable parameters

- Pan: CC#10 pan
- Volume: CC#7 volume
- Send 1/2: CC#93 send 1 level, CC#91 send 2 level

Drum Track

Drum track programs in Program mode will be triggered on the global MIDI channel if **Trigger Mode** is set to Wait KBD Trigger. The MIDI transmit channel is specified by the Drum Track **Prog MIDI Ch**. Use the Drum Track **Prog MIDI Out** to specify whether the MIDI note data of the pattern will be transmitted.

Drum track programs do not transmit or receive MIDI program changes.

Prog MIDI Ch [01...16]

This specifies the MIDI channel for drum track transmission and reception in Program mode. If **Prog MIDI Out** is checked, drum pattern note data will be transmitted on this MIDI channel. The default setting is channel 10.

Prog MIDI Out [Off, On]

On (checked): The note data of the drum track pattern will be transmitted on the channel specified by **Prog MIDI Ch**.

Off (unchecked): The note data of the drum track pattern will not be transmitted.

Step Seq

The MIDI transmit channel of the step sequencer in Program mode is specified by the Step Seq Prog MIDI Ch setting. The Step Seq Prog MIDI Out setting specifies whether MIDI note data of the pattern will be transmitted.

Drum track programs do not transmit or receive MIDI program changes.

Prog MIDI Ch [01...16]

This specifies the MIDI channel for step sequencer transmission and reception in Program mode. If **Prog MIDI Out** is checked, drum pattern note data will be transmitted on this MIDI channel. The default setting is channel 16.

Prog MIDI Out [Off, On]

On (checked): The note data of the step sequencer pattern will be transmitted on the channel specified by **Prog MIDI Ch**.

Off (unchecked): The note data of the sequencer pattern will not be transmitted.

ARP Controllers MIDI Out [Control Change, SysEx-Param Change]

This specifies the MIDI messages that will be output when you adjust the arpeggiator's MOD [GATE], [VEL], and [SWING].

Control Change: When you use the ARP button, MOD [GATE], [VEL], or [SWING], the MIDI control change messages specified in the G-INPUT/CTRL> CC page will be output.

SysEx-Param Change: Using the ARP button or MOD [GATE], [VEL] and [SWING] will transmit MIDI System Exclusive parameter change messages for the following parameters: arpeggiator on/off, **Gate**, **Velocity**, **Swing**.

1-3 FILTER

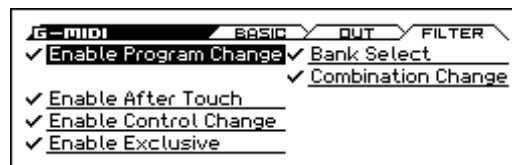

Enable Program Change [Off, On]

On (checked): Program changes will be transmitted and received.

In Program mode (PROG> MAIN), the program will be switched when a program change message is received on the global MIDI channel specified by **MIDI Channel** (G-MIDI> BASIC). When you switch programs, a program change message will be transmitted on the global MIDI channel.

In Combination mode (COMBI> MAIN), the combination will be switched when a program change message is received on the global MIDI channel. However, it is possible to set the **Enable Combination Change** parameter so that the combination is not switched. When a program change is received on the channel specified for each timbre by **MIDI Channel** (C-TIMBRE> MIDI), the program of that timbre will be switched. However, the program changes for each timbre will be affected by the setting of the **Enable Program Change** parameter (C-MIDI FILTER> 1).

When you switch combinations, a program change message will be transmitted on the global MIDI channel, and also transmitted simultaneously on the channel of timbres whose **Status** (COMBI> PROG) is set to EXT or EX2.

In Sequencer mode, incoming program change messages on a channel that corresponds to a track where the **Status** (COMBI> PROG) is set to INT or BTH will switch programs on that track.

When you select a song or play back sequencer data, program changes will be transmitted on the channels of tracks whose **Status** is set to BTH, EXT, or EX2 (see "Track MIDI Out" on page 161).

Off (unchecked): Program changes will not be transmitted or received.

Bank Select [Off, On]

On (checked): The Bank Select control change message will be transmitted together with program change messages. This is valid when **Enable Program Change** is checked.

Off (unchecked): Bank Select messages will not be transmitted or received.

When recording on the internal sequencer, bank select messages will be recorded regardless of this setting. However for playback, this setting will apply.

Combination Change [Off, On]

On (checked): When in COMBI>MAIN, an incoming program change message on the global MIDI channel set by **MIDI Channel** (G-MIDI> BASIC) will switch combinations.

This is valid when **Enable Program Change** is checked.

An incoming program change on a channel other than the global MIDI channel will switch the program of any timbre that matches that MIDI channel.

Off (unchecked): An incoming program change message on the global MIDI channel will switch the program of any timbre where the **MIDI Channel** (C-TIMBRE> MIDI) matches the global MIDI channel. The combination will not be switched.

The program changes for each timbre will be affected by the setting of the **Enable Program Change** parameter (C-MIDI FILTER> 1).

Enable After Touch [Off, On]

On (checked): MIDI aftertouch messages will be transmitted and received.

Off (unchecked): MIDI aftertouch messages will neither be transmitted nor received.

This setting has no effect when you use the internal sequencer to playback sequence data that was recorded with aftertouch data; i.e., aftertouch will be transmitted via MIDI.

Performing on the KROSS's keyboard will transmit neither channel aftertouch nor polyphonic aftertouch. However, since the KROSS does support aftertouch as an Alternate Modulation Source (AMS), it can receive aftertouch to control.

Enable Control Change [Off, On]

On (checked): Control change messages will be transmitted and received.

Off (unchecked): Control change messages will neither be transmitted nor received.

This setting has no effect when you use the internal sequencer to play back sequence data that was recorded with control change data; i.e., the control changes previously recorded into the sequencer will be transmitted via MIDI.

Enable Exclusive [Off, On]

On (checked): System Exclusive data will be transmitted and received.

Check this if you want to edit the KROSS from a connected computer, or if you want to allow bi-directional editing.

Off (unchecked): System Exclusive data will not be transmitted. Normally you will leave this unchecked.

However, System Exclusive data will be transmitted and received while the functions (**Dump Program– Dump Drum Track Pattern**) of this page are displayed.

✓ 1-1...3: FUNCTION

- 0: **Write Global Setting** see page 176
- 1: **Dump Program** see page 177
- 2: **Dump Combination** see page 177
- 3: **Dump Drum Kit** see page 177
- 4: **Dump Arpeggio Pattern** see page 177
- 5: **Dump Global Setting** see page 177
- 6: **Dump Sequence** see page 177
- 7: **Dump All** see page 177

For more information, please see the “Global, Media: FUNCTION” section on page 176.

2: G-INPUT/CTRL

2-1: AUDIO IN

About the AUDIO IN button

Settings on this page are active when the front panel AUDIO IN button is on, allowing an external audio signal to be input.



These are the general-purpose external audio input settings. They allow you to use the same external input for multiple programs or combinations, or in Sequencer mode.

To use these settings, turn on G-SET (Use Global Setting) in the INPUT/CTRL> AUDIO IN page of the appropriate mode mentioned above. (see page 5)

For details on each parameter, see Program mode “1-1: AUDIO IN”. (see page 5)

 The input gain setting (Gain) is shared by the global setting (G-SET on) and the individual setting (G-SET off). To save the setting, adjust the setting in Global mode and then use the Write Global Setting function to save it. Although you can edit this in the AUDIO IN page or the QUICK SETTING dialog box of each mode, you can't save it as an individual setting (G-SET off) for a program, combination, or song.

Select	[Line, Mic]
Pan	[L000...L063, C064, R065...R127]
Input Level Meter	
Level	[000...127]
Mute/Play	[Mute, Play]
Gain	[00...82, MAX]
Bus (Bus Select)	[L/R, IFX1...5, Off]
Send1	[000...127]
Send2	[000...127]
FX Control Bus	[Off, FC1, FC2]

See “1-1: AUDIO IN” on page 5

AUDIO IN – QUICK SETTING

If you hold down the EXIT button and press the AUDIO IN button, the current audio in setting will appear. This is referred to as the audio in quick setting. When a different page is open, this provides a convenient way to quickly access the settings without having to open the AUDIO IN page.



If G-SET is ON, the GLOBAL setting AUDIO IN is shown and can be edited. When you press the WRITE G-SET (PAGE+) button, the WRITE GLOBAL SETTING dialog box will appear, allowing you to save the setting.



2-2: FOOT

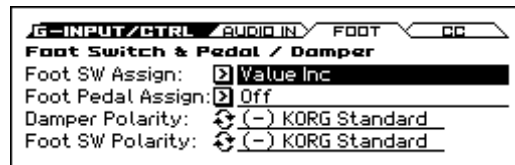

Foot Switch Assign

[List of Foot Switch Assign]

Selects the function that will be controlled by a pedal switch (such as the optional Korg PS-1 or PS-3) connected to the ASSIGNABLE SWITCH jack.

For a complete list of possible assignments, please see “MIDI transmission when the KROSS’s controllers are used” on page 293.

Foot Pedal Assign

[List of Foot Pedal Assign]

Selects the function that will be controlled by a foot volume pedal (XVP-10 or EXP-2 option [sold separately]) connected to the ASSIGNABLE PEDAL jack.

For a complete list of possible assignments, please see “Foot Switch Assign List” on page 291.

Damper Polarity

[(-) KORG Standard, (+)]

Set this to match the polarity of the damper pedal that’s connected to the DAMPER jack. If the polarity does not match, using the damper pedal will not produce the correct result. If no damper pedal is connected, set this to (-) KORG Standard.

(-) KORG Standard: Use this setting for “open-type” damper pedals, such as the optional Korg DS-1H.

(+): Use this setting for “closed-type” pedals.

Foot Switch Polarity

[(-) KORG Standard, (+)]

Set this to match the polarity of the footswitch that’s connected to the ASSIGNABLE SWITCH jack. If the polarity does not match, using the damper pedal will not produce the correct result. If no damper pedal is connected, set this to (-) KORG Standard.

(-) KORG Standard: Use this setting for “open-type” footswitches, such as the optional Korg PS-1 or PS-3.

(+): Use this setting for “closed-type” pedals.

2–3: CC (MIDI CC# Assign)

Here you can assign control change messages to the arpeggiator On/Off switch and to MOD [GATE], [VEL], and [SWING].

When you use the switch or MOD [GATE], [VEL], or [SWING], the assigned control change message will be transmitted from the MIDI OUT connector.

The assigned control change messages can also be received from an external MIDI device connected to the MIDI IN connector, and used to control the corresponding arpeggiator.

The default settings of each parameter are as shown in the display above.

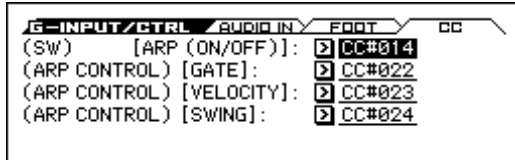

(SW) [ARP (ON/OFF)] [Off, 000...119]

Assigns a control change message sent by the ARP button. The default setting is CC#14.

(ARP CONTROL) [GATE] [Off, 000...119]

Assigns a control change message to MOD [GATE]. The default setting is CC#22.

(ARP CONTROL) [VELOCITY] [Off, 000...119]

Assigns a control change message to MOD [VELOCITY]. The default setting is CC#23.

(ARP CONTROL) [SWING] [Off, 000...119]

Assigns a control change message to MOD [SWING]. The default setting is CC#24.

✓ 2–1...3: FUNCTION

- 0: **Write Global Setting** see page 176

For more information, please see the “Global, Media: FUNCTION” section on page 176.

3: G–USER SCALE

Here you can adjust settings for sixteen different User Octave Scales and one User All Notes Scale.

The user scales you create here can be selected from the following pages.

- P–BASIC> SCALE
- C–TIMBRE> SCALE
- S–TRACK> SCALE

Note: To edit a scale, use the Program mode page listed above to select the scale that you want to edit, and then move to this page.

Note: By executing the **Copy Scale** function, you can copy the settings of a preset scale (other than Stretch) or of another user scale, and then edit the settings of the copied scale.

 If you want to keep the user scale settings that you edited, you must use the Write Global Setting function to save them before you turn off the power.

3–1: OCTAVE

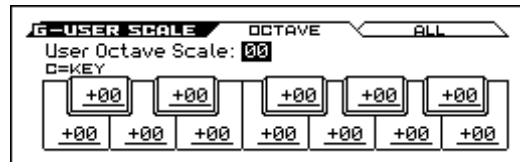

User Octave Scale [00...15]

Selects the User Octave Scale that you want to edit.

Tune [–99...+99]

Adjust pitch settings for each note in the octave.

When you adjust the pitch of each note in the octave (C–B) in one-cent steps, your settings will be applied to all octaves. This adjustment is relative to equal temperament.

A setting of –99 lowers the pitch approximately one semitone below normal pitch.

A setting of +99 raises the pitch approximately one semitone above normal pitch.

By executing the **Copy Scale** function, you can copy settings from a preset scale (other than Stretch) or from another user scale.

3-2: ALL

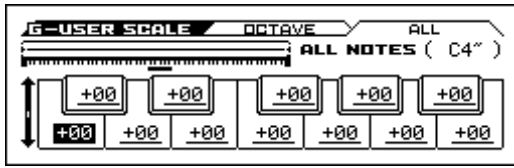

ALL NOTES

[C-1...C9]

Indicates the octave of Tune parameters C-B.

Tip: You can use the ENTER button and the keyboard to select notes.

Use the cursor buttons ▲ ▼ to switch the selected note in one-octave units.

Tune

[-99...+99]

Adjust independent pitch settings for each of the 128 notes.

Adjust the pitch of each of the 128 notes (C-1 – G9) in one-cent steps. This adjustment is relative to equal temperament.

A setting of -99 lowers the pitch approximately one semitone below normal pitch.

A setting of +99 raises the pitch approximately one semitone above normal pitch.

✓ 3-1, 2: FUNCTION

- 0: **Write Global Setting** see page 176
- 1: **Copy Scale** see page 178

For more information, please see the “Global, Media: FUNCTION” section on page 176.

4: ARP PATTERN (Arpeggio Pattern)

Here you can create user arpeggio patterns.

In this page, the KROSS will continue to sound as it did before entering Global mode.

If you entered Global mode from Program mode: Your editing will apply to the arpeggio pattern that is selected by the program. Even if the previously selected program’s arpeggiator is turned off, it can be turned on by the ARP button.

If you entered Global mode from Combination mode: Your editing will apply to the arpeggio pattern that is selected by the combination. Even if the previously selected combination’s arpeggiator is turned off, it can be turned on by the ARP button.

However, an arpeggiator whose Arpeggiator Run (COMBI> ARP, C-ARP> A, B) setting A or B is unchecked will not run. Also, the arpeggiator will not run if it is not assigned to a timbre by the Arpeggiator Assign (C-ARP> ASSIGN) setting.

If you entered Global mode from Sequencer mode: Your editing will apply to the arpeggio pattern specified for the selected song. Even if you entered Global mode from settings where the arpeggiator was turned off, you can use the ARP button to turn it on.

However, it is not possible to turn on an arpeggiator where the **Arpeggiator Run** (SEQ> ARP, S-ARP> A, B) parameter A or B is not checked. Additionally, the arpeggiator will not run if it has not been assigned to a track in **Arpeggiator Assign** (S-ARP> ASSIGN).

In each of the above cases, you can modify the settings of the arpeggio pattern even if the arpeggiator is not turned on. When editing a pattern, it is a good idea to turn on the arpeggiator and make sure that it’s the pattern that you wish to edit.



If you want the edited user arpeggio pattern settings to be backed up even when the power is turned off, you must write them into memory. Select the **Write Arpeggio Patterns** function to access the Write Arpeggio Pattern dialog box.



When you edit a user arpeggio pattern, your edits will affect all programs and combinations that use the edited pattern. If you want to edit one of the preload arpeggio patterns, you should first copy the arpeggio pattern to an unused user arpeggio pattern, and then edit it.

For details on creating an arpeggio pattern, see page 72 of the Operation Guide.

4-1: SETUP (Pattern Setup)

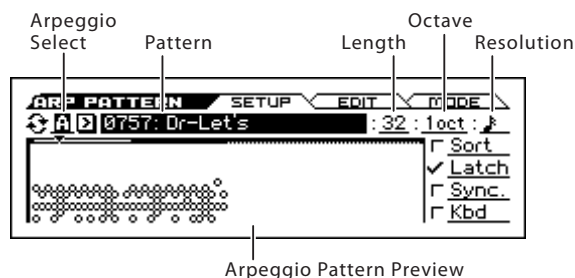

Arpeggio Select [A, B]

If the KROSS was previously in Combination or Sequencer mode and you want to edit an arpeggio pattern, you must select either arpeggiator A or B as the pattern to edit. Your editing will apply only to the selected one. B will not be displayed if the previous mode was Program mode.

Pattern [Preset: UP...RANDOM, 0000...1027]

Selects the pattern that you want to edit.

Preset: UP...RANDOM	Preset arpeggio patterns
0000...0915	Preloaded arpeggio patterns
0916...1027	User arpeggio patterns

Note: If you want to edit the arpeggio pattern name, execute the function **Rename Arpeggio Pattern**.

Length (Pattern Length) [01...48]

Specifies the length of the arpeggio pattern. The arpeggio pattern will play the number of steps that you specify here at the note value interval specified by **Resolution**, and will then begin again. This is not valid for preset arpeggio patterns Preset: UP...RANDOM.

Arpeggio Pattern Preview

This shows a graphic representation of the steps in the user arpeggio pattern.

If Arpeggio Tone Mode is set to Fixed Note, the step graphics are shown as hollow circles.

- Octave** [1oct, 2oct, 3oct, 4oct]
- Resolution** [♩₃, ♩₃, ♩₃, ♩₃, ♩₃, ♩₃, ♩₃, ♩₃]
- Sort** [Off, On]
- Latch** [Off, On]
- Key Sync.** [Off, On]
- Keyboard** [Off, On]

For more information, please see the “13-1: SETUP” section on page 51.

Pattern, Octave, Resolution, Sort, Latch, Key Sync., and Keyboard are parameters that can be set in program, combination, and Songs, but you can also set them here. If you move here from Program or Combination mode and set these parameters, you must return to the original mode and write them. These parameters cannot be written by the Write Arpeggio Patterns function on this page.

4-2: EDIT (Pattern Edit)

Here you can input Tones 0-11 for each Step 01-64. There can be up to 64 **steps**, and the **tones** represent the notes of the scale (a maximum of 12 notes) that you can press simultaneously at each step. If the **Sort** check box (ARP PATTERN> SETUP) is selected, the notes you press simultaneously will be sorted from low to high, and assigned to 0, 1, ... 11. If the **Sort** check box is not selected, the notes will be assigned to 0, 1, ...11 in the order that you press them.

To input the Tone, use the cursor buttons ◀▶▲▼ to select the Step, and press the ENTER button. The tone will alternate on/off each time you press the button.

These parameters are not valid for preset patterns Preset: UP-RANDOM.

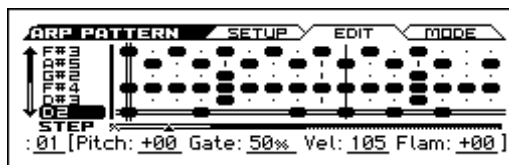

Step (Step Number) [01...48]

Use this to select the step that you want to edit.

Pitch Offset [-48...+48]

For each step, the pitch corresponding to the **Tone** can be raised or lowered in semitone steps. This lets you adjust settings for the same tone in each step to create a melody, or to adjust settings for two or more tones in each step to play parallel chords.

Gate [Off, 001...100%, LGT]

Off: Even if a tone has been entered, it will not sound at that step. You can also use this to stop a legato tone that was previously sounding.

LGT (Legato): The tone will continue sounding until the same tone is played again (including Gate: Off) or the pattern returns to its beginning.

The Legato setting is valid if the **Gate** parameter (P-ARP> SETUP, C-ARP> SETUP, S-ARP> SETUP) of each program, combination, or song is set to Step. If you specify Legato, make sure that the **Gate** of the previous mode is set to Step.

Velocity [001...127, Key]

Key: The Tone of the step will sound with the velocity used when the key was played.

001-127: The specified velocity value will always be used.

This setting is valid when the Program, Combination, or Song parameter **Velocity** (P-ARP> SETUP, C-ARP> SETUP, S-ARP> SETUP) is set to **Step**.

When using this setting, make sure that **Velocity** is set to **Step** in the previous mode before entering this page.

Flam [-99...+99]

Specifies how the note timing will be skewed when two or more **Tones** are specified in the same step.

00: All **Tones** will sound simultaneously.

+01...+99: The timing of the notes will be skewed in the order of the Tone number. (When **Sort** is ON, from low note to high note. When **Sort** is OFF, in the order in which keys were pressed.)

-01...-99: The timing of the notes will be skewed in the opposite direction as “+.”

To simulate chords strummed on a guitar, try setting “+” values for odd-numbered steps and “-” values for even-numbered steps.

4-3: MODE



These parameters are not valid for preset patterns Preset: UP-RANDOM.

Arpeggio Type [As Played... Up&Down]

Specifies the relationship between the arpeggio notes specified from the keyboard and the Tone at each step.

As Played: If there are more Tones in a step than arpeggio notes specified (notes played on the keyboard), those steps will not sound.

As Played (Fill): If there are more Tones in a step than arpeggio notes specified (notes played on the keyboard), the last-played note (**Sort** is Off), or the highest note (**Sort** is On) will sound for those steps.

Running Up: If there are more Tones in a step than arpeggio notes specified (notes played on the keyboard), the arpeggio will return to the first note (if **Sort** is Off), or the lowest note (if **Sort** is On) and sound it.

Up&Down: If there are more Tones in a step than arpeggio notes specified (notes played on the keyboard), the arpeggio will return in reverse direction from the last arpeggio note back toward the first.

Example

If you set Length to 04, Step No. 01 to Tone0, Step No. 02 to Tone1, Step No. 03 to Tone2, Step No. 04 to Tone3, and simultaneously play three notes to produce an arpeggio, the following results will be produced depending on the Arpeggio Type.

As Played: 0 → 1 → 2 → rest → 0 → 1 → 2 → rest → 0 ...

As Played (Fill): 0 → 1 → 2 → 2 → 0 → 1 → 2 → 2 → 0 ...

Running Up: 0 → 1 → 2 → 0 → 0 → 1 → 2 → 0 → 0 ...

Up&Down: 0 → 1 → 2 → 1 → 0 → 1 → 2 → 1 → 0 ...

Octave Motion [Up, Down, Both, Parallel]

Specifies the operation when **Octave** is set to 2-4 octaves.

Resolution = ♩, Swing = +25
When **Step/Bt = X1**

Resolution = ♩, Swing = +25
When **Step/Bt = X2**

Resolution = ♩, Swing = +25
When **Step/Bt = X4**

Up: Notes will repeatedly ascend within the specified range of octaves.

Down: Notes will repeatedly descend within the specified number of octaves.

Both: Notes will repeatedly ascend and descend within the specified number of octaves.

Parallel: The notes of the specified octaves will sound simultaneously.

Steps per Beat [x1, x2, x4]

Specifies the steps where the swing effect will be applied.

The amount of swing that will be applied is specified by the Swing parameter of each program, combination, or song (PARP> SETUP, C-ARP> A, B, S-ARP> A, B) and by the MOD [Swing] parameter in the ARP page of each mode. (When the MOD [Swing] parameter is at +00, the effect will be as specified by the value of the Swing parameter.)

x1: Swing will be applied to the even-numbered steps 2, 4, 6, 8 ...

x2: Swing will be applied to steps 3, 7, 11, 15 ... For example if you set Resolution to ♩ and enter an 8-beat rhythm, the swing effect will be applied to the 8-beat.

x4: Swing will be applied to steps 5, 13, 21, 29 ... For example if you set Resolution to ♩ and enter an 8-beat rhythm, the swing effect will be applied to the 8-beat.

(See illustration below)

Tone Mode (Arpeggio Tone Mode) [Normal, Fixed Note]

This selects the **Tone** type of the arpeggio pattern.

Normal: This is the conventional arpeggiator type. Each Tone in the arpeggio will play based on the note number of the keys that you are pressing on the keyboard.

Fixed Note: The note number of each tone is fixed. The note numbers played on the keyboard will be ignored, and the arpeggio will sound using specified pitches. Note numbers from the keyboard will only control the trigger timing of the arpeggiator. Fixed Note mode is ideal for arpeggio patterns that you are using as drum patterns.

In the ARP PATTERN> SETUP page, the Tone indicators will be “●” when Normal is selected here or “○” when Fixed Note is selected.

Fixed Note Mode [Trigger As Played, Trigger All Tones]

When the **Arpeggio Tone Mode** is Fixed Note, this specifies the condition that will trigger the Tones.

Trigger As Played: The Tones will be triggered according to the number of keys pressed.

Trigger All Tones: Pressing a single key will trigger all Tones.

Example)

We will use an **Arpeggio Tone Mode** Fixed Note pattern on drums. Tone 0 is assigned a note number that will sound a kick, Tone 1 a snare, and Tone 2 a hi-hat.

With a setting of **Trigger As Played** and **ArpeggioType** is As Played, pressing one key will sound only Tone 0 (kick). Pressing two keys will sound Tone 0 (kick) and Tone 1 (snare). Pressing three keys will sound all three Tones 0–2 (kick, snare, hi-hat). If the **Velocity** of each Tone is set to Key, each Tone will be sounded at the velocity used when each key was played.

With a setting of **Trigger All Tones**, playing one key is sufficient to sound all three; Tone 0 (kick), Tone 1 (snare), and Tone 2 (hi-hat). If the **Velocity** of each Tone is set to Key, the Tones will be sounded at the corresponding velocity each time a key is pressed.

Mode (Fixed Note Mode)

This opens the Fixed Notes dialog box. Here you can specify the notes that will be used when **Arpeggio Tone Mode** is set to Fixed Note.

✓ 4-1...3: FUNCTION

- 0: **Write Arpeggio Patterns** see page 178
- 1: **Rename Arpeggio Pattern** see page 178
- 2: **Copy Arpeggio Pattern** see page 179
- 3: **Initialize Steps** see page 179
- 4: **Copy Step** see page 179 (only EDIT page)
- 5: **Delete Step** see page 179 (only EDIT page)
- 6: **Insert Step** see page 179 (only EDIT page)
- 7: **Rotate Step** see page 179 (only EDIT page)

For more information, please see the “Global, Media: FUNCTION” section on page 176.

5: DRUM KIT

Here you can create drum kits by assigning a drum instrument (drum sample) to each key.

A drum kit you edit here can be used in the same way as a multisample oscillator (when **Oscillator Mode** is Single or Double) and processed through the filter, amp, and effects etc. To do this, set the **Oscillator Mode** to Drums in the Program mode P–BASIC> VOICE page, and selecting the drum kit as an oscillator in the P–OSC> Dkit page.

Getting ready to edit

- When you wish to edit a drum kit, enter Program mode, select a program that uses a drum kit (i.e., whose **Oscillator Mode** is Drums), and then move to this page. A program that uses a drum kit will already have filter, amp, and effect settings etc. suitable for drum sounds.
- You must set **Octave** (P–OSC> Dkit) to +0[8']. With any setting other than +0[8'], the key locations and drum sounds will not correspond correctly.

Moving to the Global DRUM KIT page

- If you moved from another program or mode, the OSC1 drum kit that was selected most recently for the program will be recalled.
- Even if a program with an **Oscillator Mode** of Single or Double is selected in Program mode, the program will sound using its own filter and amp settings etc.
- Effects will sound according to the settings of the program you selected.



Editing a Drum Kit

For detailed step-by-step instructions on creating drum kits, please see “Using Drum Kits” section on page 93 of the Operation Guide.

 If **Enable Exclusive** (G–MIDI> FILTER) is checked, the drum kit can be edited using exclusive data.

Saving Drum Kits

When you execute the Write Drum Kits function, all drum kits will be saved.

-  Unlike when editing a program or combination, your edited content will temporarily remain even if you select a different drum kit, but will be lost when you turn off the power. If you want to keep the settings of an edited drum kit even after power-off, you must execute **Write Drum Kits**.
-  Editing a drum kit will affect all programs that use the edited drum kit. When editing a preloaded drum kit, it's a good idea to copy the drum kit to an empty area in the user bank before editing it.

5-1: DS 1 (Drumsample 1)

Here you can select a drum kit and specify Drumsample 1-4 as the drum samples assigned to each key. Here you can also edit drum sample parameters for each Drumsample.

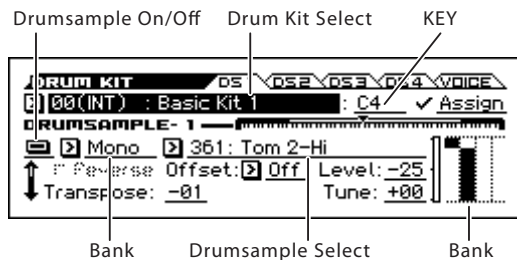

Drum Kit Select [00(INT)...47(USER)]

Selects the drum kit that you wish to edit.

No. (Bank)	Contents
00(INT)...31(INT)	Preloaded drum kits
32(USER)...47(USER)	User drum kits

KEY [C-1...G9]

Selects the key where the drum sample (and its settings) will be assigned.

Tip: You can also set the note value and velocity value by the keyboard (see page 12 of the Operation Guide).

If you check **Assign** for the key you select here the Drumsample 1-4, Voice Assign Mode, and Mixer parameters (see below) will be used.

Assign [Off, On]

On (checked): The drum samples you assigned for Drumsample 1-4 will sound. Normally you will check this parameter.

Off (unchecked): The selected drum samples will be invalid, and the drum samples of the key to the right will sound. At this time, the pitch will be a semitone lower than the pitch of the key to the right. Uncheck this parameter when you wish to play a drum sample at differing pitches.

Drum Kit, Key Select, Assign

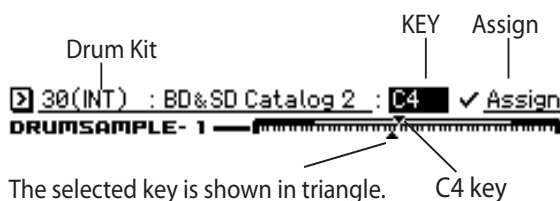

The selected key is shown in triangle. C4 key

Drumsample-1

Use Drumsample 1-4 to specify up to four drum samples.

For each drum sample, you can adjust the transposition, tuning, filter cutoff, resonance, attack, and decay. These settings are added to the settings of the program.

These are the settings for the first (High) velocity zone.

If you want to create a simple setup using only one drum sample, adjust the appropriate settings in Drumsample 1, and then set **BottomVel.** to 1 and **Xfade** to Off.

Drumsample On/Off [Off, On]

On (checked): Check this if you want to use Drumsample 1. The selected drum sample will sound.

Off (unchecked): Drumsample 1 will not be used. The drum sample will not sound.

Note: Normally, you will start by using Drumsample 1 (before using Drumsample 1-4). If you don't want to switch drum samples by velocity, turn on only Drumsample 1. If you're using multiple velocity-switched drum samples, adjust the settings as follows.

One velocity zone

Drumsample 1: On, Drumsample 2-4: Off

Two velocity zones

Drumsample 1, 2: On, Drumsample 3-4: Off

Four velocity zones

Drumsample 1-4: On

Bank [Mono, Stereo]

Drumsample Select [List of installed Drumsample]

Specify the Drumsample 1 drum sample by bank and drum sample number.

Bank selects either Mono or Stereo drum samples. However, stereo drum samples will use twice as many voices as mono drumsamples.

If you choose "Bank" Mono

Mono drum samples will be displayed. The L-channel or R-channel of the stereo drum samples selectable via Bank: Stereo can also be selected as mono drum samples. In these cases, -L or -R is shown following the drum sample of the same name

If you choose "Bank" Stereo:

Only stereo drum samples will be displayed.

When you select the **Drumsample Select** and press the ENTER button, a drum sample list will appear, allowing you to choose drum samples from the list.

Use the cursor buttons ◀▶ to select a category, use the cursor buttons ▲▼ to select a drum sample within that category, and press the ENTER button to confirm your choice. If you press cursor buttons ◀▶ simultaneously, the first sample in the selected category will be selected. An "➔" symbol is shown to the left of the first sample.

It is not possible to edit the category names of drum samples, or to re-assign the category.

Reverse [Off, On]

This lets you play the selected drum sample backwards, without looping. However, some preset drum samples cannot be reverse-played, and consequently, they cannot be selected.

On (checked): The drum sample will play back in reverse.

The location where reverse playback starts and ends is already specified for each drum sample.

For unselected velocity zones (shown as a single line), **Rev On** is indicated as [R].

Off (unchecked): The drum sample will play back normally.

Offset (Start Offset) [Off, 1st...6th]

In addition to simply starting playback from the beginning, drum samples can have up to 6 different pre-programmed alternate starting points. However, you can't select drum samples where start and offset points are not specified.

With drum samples, the Start Offset specifies whether to use the normal start point (**Off**), or to use one of the alternate start points (**1st-6th**).

Some drum samples may have fewer than 6 pre-programmed points, in which case only the available points can be selected.

Level (Amp Level) [-99...+99]

Specifies the volume.

Keys where a value of +99 is specified will sound at a volume twice as high as the amp level of the program which uses that drum kit. Keys where a value of 0 is specified will sound at the volume of the amp level of the program which uses that drum kit. Keys where a value of -99 is specified will not sound.

Transpose [-64...+63]

Adjusts the pitch in semitone steps. +12 is one octave up, and -12 is one octave down.

Tune [-99...+99]

This adjusts the pitch in cents, over a range of ±1 octave. A cent is 1/100 of a semitone.

Cutoff (Filter Cutoff) [-64...+63]

Adjust the cutoff frequency of the filter. The cutoff frequency for each key and drum sample is determined by adding this value to the filter **Frequency** (P-FILTER> BASIC) of the program that uses this drum kit.

Resonance (Filter Resonance) [-64...+63]

This adjusts the filter resonance. This offset value for each key and drum sample is applied to the filter **Resonance** (P-FILTER> BASIC) of the programs that use this drum kit.

Attack (Amp EG Attack) [-64...+63]

Adjusts the attack time of the volume (Amplifier). The attack time for each key is determined by adding this value to the amp EG Attack Time of the program that uses this drum kit.

Decay (Amp EG Decay) [-64...+63]

Adjusts the decay time of the volume (Amplifier). The decay time for each key is determined by adding this value to the amp EG Decay Time of the program that uses this drum kit.

Bottom Vel. (Bottom Velocity) [1...127]

This sets the lowest velocity where the drum sample will sound. Drumsample 1's **Bottom Velocity** can be equal to, but not lower than, than that of Drumsample 2.

Xfade (Crossfade Range) [Off, 1...127]

This specifies the velocity range starting at **Bottom Velocity** where Drumsample 1 will fade-out and Drumsample 2 will fade-in.

For instance, if the **Bottom Velocity** is set to 64, and the **Crossfade Range** is set to 20, Drumsaple 2 will start to fade in at velocities of 84 and below.

When velocities are within the **Crossfade Range**, the Oscillator will use twice as much polyphony as it would normally.

Note: You can only fade between two zones at once.

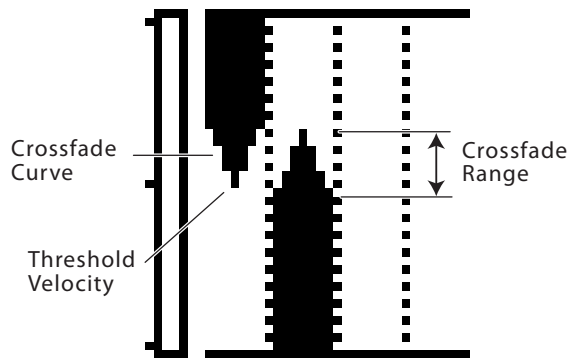

Curve [Linear, Power, Layer]

This controls the volume curve of the crossfade. **Linear** and **Power** (short for Equal Power) let you fine-tune the way that the two drum samples mix together; one or the other may be more appropriate for a given pair of drum samples. **Layer**, true to its name, lets you layer the two drum samples together without any crossfading.

Linear means that the two samples will each be at 50% of their full volume in the middle of the crossfade. Sometimes, this may create a dip in the volume level; if so, try using **Power** instead.

Power, short for Equal Power, means that the two samples will each be at around 70% of their full volume in the middle of the

crossfade. Sometimes, this may create a bump in the volume level, in which case you might try selecting **Linear** instead.

Layer means that the two drum samples will be layered together, both at full volume, for the entire range of the crossfade.

Crossfade Curves

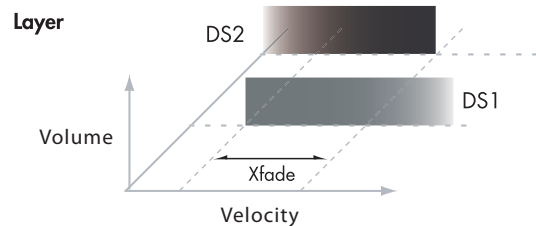
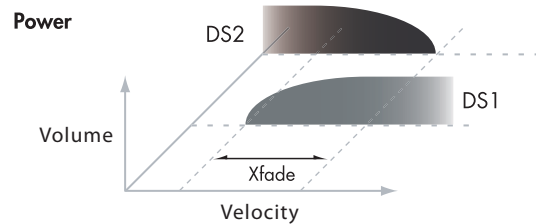
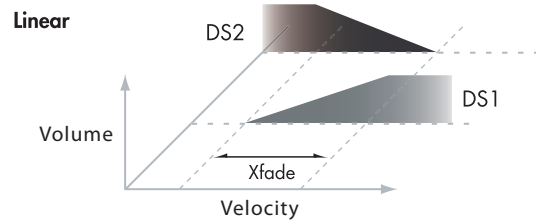

Vel Map Graphic

This indicates the velocity zones of four drum samples.

The meter on the left indicates the note-on velocity values. This lets you verify the drum sample(s) that will be sounded by each velocity (see "Velocity Split" on page 12).

5–2...4: DS2...DS4 (Drumsample2...4)

Here you can edit the sample parameters for Drumsample 2–4. For more information, please see “Drumsample-1” on page 170.

The parameters for Drumsample 4 are also similar to those for Drumsample 1, except that Drumsample 4 has no settings for Bottom Velocity (which is always fixed at 1), Crossfade Range, or Curve.

5–5: VOICE

Specify the voice assign, pan, and effect routing etc. for each key of the drum kit.



Drum Kit Select [00(INT)...47(USER)]
KEY [C–1...G9]
Assign [Off, On]

See “5–1: DS 1 (Drumsample 1)” on page 170

VOICE ASSIGN

Single Trigger [Off, On]

On (checked): Even when the same key (note) is played repeatedly, the previous note will be halted before the new note is begun, so that the notes will not overlap. Normally you will leave this unchecked.

Excl Group (Exclusive Group) [Off, 001...127]

001–127: This allows you to assign keys to any of 127 groups. Keys assigned to the same group will be treated as a single group, and will be played monophonically with last-note priority. For example you might assign closed and open hi-hat sounds to the same group so that two or more hi-hat sounds can not sound simultaneously.

Off: Keys will not be grouped. This is the default setting.

Inst Type (Instrument Type) [Kick...SFX]

This specifies the type of drum instrument that's assigned to each key. The instruments that can be selected for each Tone Group of the step sequencer will depend on the type that you specify here.

For example if this is set to Kick, you'll be able to select from the step sequencer's Tone Group “Kick.” If this is set to Snare, you'll be able to select from the Tone Group “Snare1” and “Snare2.”

Note-On (Enable Note-On Receive) [Off, On]

On (checked): Note-on messages will be received. Normally you will check this, but you can uncheck it if you do not want specific notes to sound.

Note-Off (Enable Note-Off Receive) [Off, On]

On (checked): Note-off messages will be received. Normally you will uncheck this. This is effective if **Hold** (P–BASIC> NOTE-ON) is ON. In the case of a drum program, you will normally select Hold On. In this case if **Enable Note Off Receive** is checked, note-off messages will be received, and the sound will stop (the release segment of the EG will begin) when the key is released.

MIXER

 In Program mode, Drum kits will sound using the settings of the selected program. **Pan** is valid if **D-KIT SET** (P–AMP> BASIC) is checked. **Bus Select**, **FX Control Bus**, and **Send 1/2** are valid if **D-KIT SET** (P–FX ROUTING> BUS) is checked. Be aware that while editing a drum kit, the edited results will not be reflected unless these settings have been made.

Pan [Rndm, L001...C064...R127]

Specifies the panning for each key.

L001 places the sound at far left, and **R127** places the signal at far right. With a setting of **Rndm (Random)**, the drum sample will be panned randomly at each note-on.

Bus Select [L/R, IFX 1...5, Off]

For each key, specify the bus where the sound will be sent.

For example, you might send Snare sounds to IFX1 and Kick sounds to IFX2 to apply separate insert effects, and send the remaining sounds to L/R without applying insert effects.

Tip: In most of the preloaded drum kits, the following types of drum instrument have the same **Bus Select** settings.

Snares → IFX1

Kicks → IFX2

Cymbals → IFX3

Toms, percussions, others → IFX4

FX Control Bus [Off, FC1, FC2]

For each key, you can select whether the signal will be sent to FX Control bus (stereo two-channel) FX Ctrl1 or 2.

Normally you will leave this off, but you can use this setting if you want to control an effect by playing a specific key.

You can use this with the following effects:

Vocoders:

D09: Vocoder

Compressor and gate-type effects:

S03: Stereo Limiter

S06: Stereo Gate

For examples of how to use this, see page 199.

Send1 (to MFX1) [000...127]

Send2 (to MFX2) [000...127]

For each key, specify the send levels to master effects 1 and 2.

These settings are valid when **Bus Select** is set to L/R or Off. If **Bus Select** is set to IFX1–5, the send level to master effects 1 and 2 will be determined by the Program, Combination, or Sequencer mode P8: Routing/IFX–Insert FX Setup page parameters **Send1** and **Send2** which are located after the sound passes through IFX1–5.

✓ 5-1...5: FUNCTION

- 0: **Write Drum Kits** see page 179
- 1: **Rename Drum Kit** see page 179
- 2: **Copy Drum Kit** see page 180
- 3: **Copy Key Setup** see page 180
- 4: **Swap Key Setup** see page 180

For more information, please see the “Global, Media: FUNCTION” section on page 176.

Media mode

6: MEDIA

In this mode, you can save internal memory data to an inserted SD card, or load data from media into internal memory. You can also copy or delete files, or format media.

The following media can be used.

SD cards

SD and SDHC memory cards supporting MS-DOS format FAT16 or FAT32 are supported.

SDXC memory cards are not supported.

For more information about handling the SD card, please see the "Using an SD card" section on page 21 of the Operation Guide.

Files, directories, and icons

The KROSS manages data on media in a hierarchical manner, using files and directories. The contents of a file (whether it is a file or a directory) are indicated not only by the name, but also graphically, by an icon. Files and directories have differently shaped icons.

The KROSS collectively refers to files and directories recognizable by MS-DOS (readable by an MS-DOS computer), as "DOS files" and "DOS directories." Different types of DOS file are distinguished by the extension added to their filename.

In the case of a DOS file with an extension other than listed below, selecting **Load selected** to access the dialog box will cause the file to be considered to be a Standard MIDI File (SMF).

If there are DOS files with a file name extension other than those listed below, they will be recognized as Standard MIDI Files (SMF). However, you can't load files that are not in SMF format 0/1.

Extension	Type
.PCG	Programs, combinations, drum kits, global settings, favorites, arpeggio patterns, drum track patterns (dedicated KROSS format)
.SNG	Song (dedicated KROSS format)
.MID	Standard MIDI File (SMF format 0/1)
.WAV	Audio data (44.1 kHz or 48 kHz, 16-bit stereo files)

When you format media on the KROSS or save to it for the first time, or when you create a song on the audio recorder, a directory named KORG/KROSS/DATA will be automatically created in the root directory.

Note: An AUDIO directory for the audio recorder will also be created together with the DATA directory, but this will not be shown on the KROSS.

When KROSS data is saved, one of these filename extensions will be added automatically, according to the type of data. If these filename extensions are modified on a computer, the file will be treated as an undefined file when it is reloaded back into the KROSS, and will be handled as a Standard MIDI File.

Files handled by the KROSS are illustrated with their structure (see next page). Since .PCG and .SNG files can be opened to divide their contents, they are displayed as directory icons

Files that can be loaded

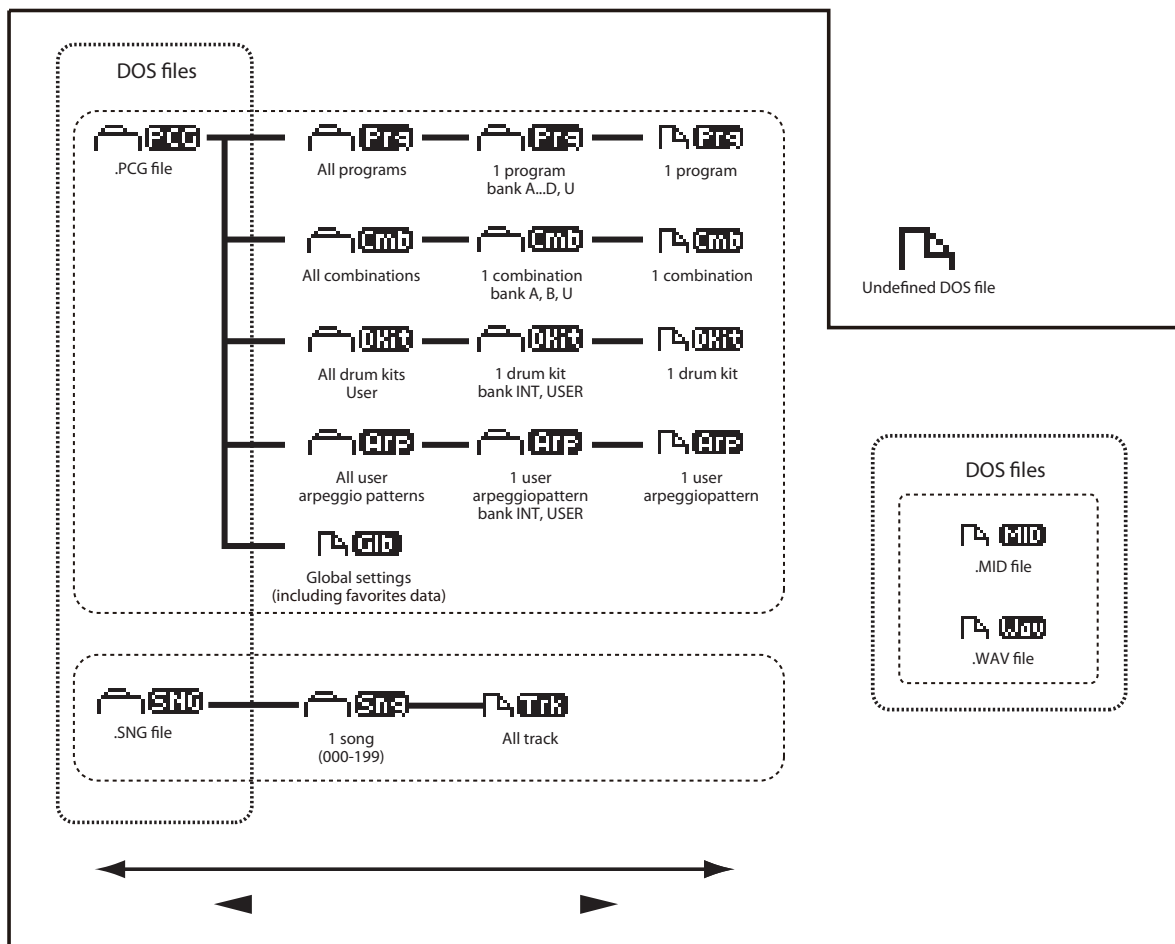

6-1: FILE

Index	File Type	File	Size	Date
0001	SN0	FRANK5.SNG	75K	01/03/2013 00:00
0002	PC0	NEWFILE.PCG	3.22M	01/03/2013 00:00
0003	SN0	NEWFILE.SNG	31K	01/03/2013 00:00
0004	W00	NEW_AUDI.WAV	13.2M	01/03/2013 00:00

Media: NEW VOLUME Index: 0001 (/4)

Use the cursor buttons ◀ ▶ ▲ ▼ to select the desired file or directory, and then execute the Load Selected function. (see page 176)

Here you can also save various data from internal memory to media. Execute the appropriate Save function. (see page 183)

Save functions can be executed in the same directory as the .PCG or .SNG file.

The KROSS does not contain an internal calendar or clock, you must use Utility function **Set Date/Time** to set the date and time before saving the file.

Media

This shows the type and volume label of the inserted device.

Volume label:

No Label: Media that has no volume label

Unformatted: Media that has not been formatted

No Media: Media is not inserted in the card slot.

The volume label display will depend on the inserted media and the page.

PCG Preview

If you selected just a single program, combination, or drum kit from within a .PCG file (i.e., from an opened bank), you can listen to the sound directly from the media without having to load the file. If you've selected a combination, the timbres in the combination will use the KROSS's internal programs. In the case of a user drum kit, the sound parameters of the program that was selected before entering Media mode will be used.

Current Directory

The directory currently selected for processing is referred to as the "current directory."

To change the current directory, use the cursor buttons ◀ ▶.

Index	File Type	Data Type	File	Size	Date
0001	SN0		FRANK5.SNG	75K	01/03/2013 00:00
0002	PC0		NEWFILE.PCG	3.22M	01/03/2013 00:00
0003	SN0		NEWFILE.SNG	31K	01/03/2013 00:00
0004	W00		NEW_AUDI.WAV	13.2M	01/03/2013 00:00

Index

This is a number attached to the file.

File Type

This is an icon that represents a file or directory.

Data Type

This icon represents the type of data, such as PCG, SNG, or WAV.

File

This is the low-level DOS file name.

Size

This is the size of the file, in bytes.

Date

This is the date and time when the file was saved. From the left, this is shown as day, month, year, hours and minutes.

However since the KROSS does not contain an internal calendar or clock, you must use Utility function **Set Date/Time** to set the date and time before saving the file.

6-2: UTILITY

Here you can rename, copy, or delete the selected media or file, create a new directory, format, and set the date and time.

After selecting media or a file, select the desired function.

Index	File Type	File	Size	Date
0001	SN0	FRANK5.SNG	75K	01/03/2013 00:00
0002	PC0	NEWFILE.PCG	3.22M	01/03/2013 00:00
0003	SN0	NEWFILE.SNG	31K	01/03/2013 00:00
0004	W00	NEW_AUDI.WAV	13.2M	01/03/2013 00:00

Media: NEW VOLUME Index: 0001 (/4)

6-3: INFO

The MEDIA screen shows information about the media.

MEDIA	FILE	UTILITY	INFO
Vol. Label: NEW VOLUME	Format:	MS-DOS	
Device ID: 0	Total Size:	1.9G	
Dev. Type: SD Card	Free Size:	1.6G	
Product ID:	Write Protect:	Off	
	Removable:	Yes	

Volume Label: The volume label of the media.

Device ID: The assigned device ID.

Dev. Type: The type of device.

Product ID: (Not shown on the KROSS)

Format Type: The type of format. If not formatted, this will indicate "Unformatted."

Total Size: The capacity of the media (in bytes).

Free Size: The free capacity of the media (in bytes).

Write Protect: The write protect status of the media. This will indicate "On" if protected, or "Off" if not protected.

Removable: Removable disk.

▼ 6-1, 2: FUNCTION

6-1

- 0: **Load Preload/Demo Data** see page 176 (only FILE page)
- 1: **Save All (PCG & SEQ)** see page 183 (only FILE page)
- 2: **Save PCG** see page 183 (only FILE page)
- 3: **Save SEQ** see page 184 (only FILE page)
- 4: **Save to Standard MIDI File** see page 184 (only FILE page)

6-2

- 0: **Rename** see page 184 (only UTILITY page)
- 1: **Delete** see page 184 (only UTILITY page)
- 2: **Format** see page 184 (only UTILITY page)
- 3: **Set Date/Time** see page 185 (only UTILITY page)

For more information, please see the "Global, Media: FUNCTION" section on page 176.

Global, Media: FUNCTION

Procedure for each function

1. Press the FUNCTION button to open the function list.
2. Adjust settings in the dialog box.

For details on the settings in each dialog box, refer to the explanation of each function.

3. Press the OK button to execute, or press the Cancel button if you decide not to execute.

Write Global Setting

Write Global Setting is available on all of the tabs under the GLOBAL G–MIDI, G–INPUT/CTRL, and G–USERSCALE pages.

This function writes Global mode settings (except for Drum Kits and Arpeggio Patterns).

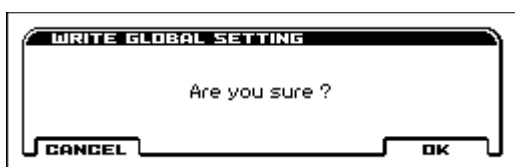

The following are exceptions.

Parameters that are not saved even if you Write

- Effect SW

Parameters that are saved even if you don't Write

- LCD Contrast
- Auto Rec Start

Load Preload/Demo Data

Load Preload/Demo Data is available on the GLOBAL pages.

This function loads the preloaded data and demo song data into the KROSS.

Before you can load this data, you must navigate to **Memory Protect** (GLOBAL> SYSTEM) and un-check the protect setting for the type of data you want to load. If you perform this function with the protect setting checked, the display will indicate "Memory Protected," and the data will not be loaded.

When you perform this function, the data of the preload banks will be rewritten. If you want to keep the data of the preload banks, use "Save All" and "Save PCG" to save it before you continue.

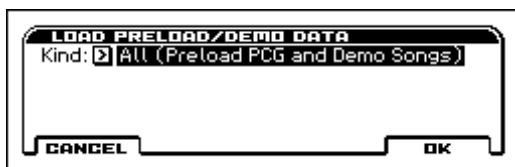

1. Use Kind to select the type of data you want to load.

Kind	Content
All (Preload PCG and Demo Songs)	All PCG (Program, Combination, Global settings, drum kit, , arpeggio pattern), and demo song data
All Preload PCG	All PCG data
All Demo Songs	All demo song data
Program	Program data
Combination	Combination data
Drum Kit	Drum kit data
Arpeggio Pattern	Arpeggio pattern data

Kind	Content
Global Setting	Global setting data, Favorites data

2. If you selected **Program, Combination, Drum Kit, or Arpeggio Pattern** as the Kind, specify the range of data that you want to load.

All: load all data

Bank: load an individual bank

Single: load one item of data

3. If you're loading **Bank or Single**, use **To** to specify the loading-destination.

Change all bank references

Change all bank references is available on the GLOBAL pages.

This function changes all program banks specified for timbres in combinations or tracks of songs.

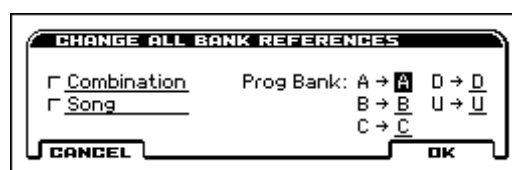

1. If you wish to change bank references for combinations, check **Combination**.

If you wish to change bank references for songs, check **Song**.

2. In **Program Bank**, specify the replacement for each bank.

If you change two or more different banks to the same bank, it will not be possible to use this function to change them back to different banks. Be careful that the change destination banks do not overlap.

Half Damper Calibration

Half Damper Calibration is available on the GLOBAL pages.

If a damper pedal that supports half damper (the DS–1H option) is connected to the DAMPER jack, here's how you can adjust the sensitivity if the damper effect is not applied appropriately.

Since the half-damper pedal is highly sensitive, please use the optional DS–1H. Other pedals may not produce the appropriate effect, or may be impossible to calibrate correctly.

1. Connect a half-damper pedal to the DAMPER jack.
2. Select "Half Damper Calibration" to open the dialog box.

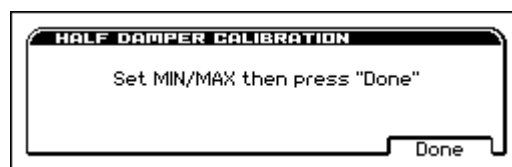

3. Press the half-damper pedal, and then release your foot from the pedal.
4. Press the Done button.

If the adjustment could not be performed correctly, an error message will be displayed. Please perform the procedure once again.

Update System Software

Update System Software is available on the GLOBAL pages.

Here you can update the KROSS system.

You can download the latest system file onto your computer from the Korg website (<http://www.korg.com/>). For details, please see the Korg website.

 Before you begin the system update, you should back up your important data on an SD card.

1. Insert the SD card containing the system file into the SD card slot of the KROSS.

Note: For details on how to copy the system file to your SD card, please see the explanation on the download page of the Korg website.

2. Access the GLOBAL> BASIC page.
3. Select “Update System Software” to open the dialog box.



4. Press the OK button to execute the update.

A dialog box will ask you for confirmation. Press the OK button to begin updating the system software.

Note: If an error message of “File/path not found” appears, press the OK button and proceed again from step 1.

 While the system is being updated, do not touch the KROSS’ switches, and never turn off the power. If the power is accidentally turned off while the system is being loaded, the KROSS may become inoperable. If this occurs, please contact your local Korg distributor.

5. When the update has been completed, a dialog box with the following message will appear.

The system update has now been installed. To complete the process, you must now restart the KROSS. Please turn the power off, and then on again.

“Completed. Please turn the power off, and then on again.”

6. Power-off the KROSS. Wait for several seconds, and then turn the power on again.

Note the system version that is displayed in the lower right of the opening screen.

Dump:

Dump Program

Dump Combination

Dump Drum Kit

Dump Arpeggio Pattern

Dump Global Setting

Dump Sequence

Dump All

These functions are available on the MIDI page.

These functions allow the internal data from the KROSS to be transmitted to another KROSS, MIDI data filer, or computer in the form of MIDI System Exclusive data.

Select the desired function (please see the following table), and a dialog box will appear.

Then, select the bank or timbre etc. of the data to be dumped, and press the OK button.

Dump Program	Programs of all banks, programs of one bank, one program
Dump Combination	Combinations of all banks, combinations of one bank, one combination
Dump Drum Kit	All drum kits, one drum kit
Dump Arpeggio Pattern	All arpeggio patterns, one arpeggio pattern
Dump Global setting	Global settings (except for the Drum Kits and Arpeggio Patterns of Global mode)
Dump Sequencer	All song data
Dump All	All of the above data

Sending SysEx data dumps

 Do not touch the KROSS’s switches or turn off the power while SysEx data is being transmitted.

Sending a data dump

1. Connect the KROSS to the device that will receive the data dump.

If you want to transmit the data to a computer that is able to receive SysEx messages, connect the KROSS’s USB connector to your computer’s USB connector.

If you want to transmit the data to another KROSS or to a MIDI data filer, connect the KROSS’s MIDI OUT connector to the MIDI IN connector of the receiving device.

2. Select GLOBAL G–MIDI page.
3. The following illustration shows the dialog box that will appear when Dump Program is selected.

If you want to dump one bank, select **Bank**, or if you want to dump one program select **Single**.

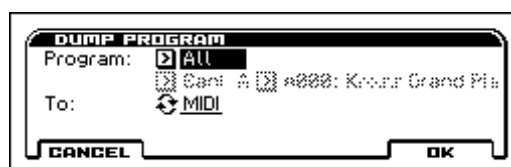

4. Use the To field to select the output connector that will transmit the data.

MIDI: MIDI OUT connector

USB: USB connector

5. Press the OK button to transmit the data.

While the data is being transmitted, the display will indicate “Now Transmitting MIDI data.”

The size of the data and the time required for transmission will depend on the type of data.

The following table shows the size of each data dump, and the time required (MIDI).

Type of data to be dumped	Data size (Bytes)	Time required MIDI (Sec.)	Time required USB-MIDI (Sec.)*1
Program All	1565375	500.92	6.25
Program Bank	314762	100.72	1.26
Program Single	2469	0.79	0.01
Combination All	869007	278.08	3.47
Combination Bank	291338	93.23	1.15
Combination Single	2286	0.73	0.01
Drum Kit All	479434	153.42	1.91
Drum Kit Single	9998	3.20	0.03
Arpeggio Pattern All	648545	207.53	2.58
Arpeggio Pattern Single	654	0.21	0.01
Global Setting	6884	2.20	0.03
Sequencer	21927...1961194	7.02...627.58	0.09...3.93
Dump All	3591172	1149.18	14.43

*1: The USB-MIDI dump times listed here are for when the KROSS is connected to a computer with a USB 1.1 port. The time required will change depending on the computer system you're using.

Note: More time will be required if the song data contains System Exclusive events, since these must be converted.

When performing a data dump from the KROSS onto a MIDI data filer, do not transmit multiple data dumps together. If multiple data dumps are saved together, then when the data is re-transmitted from the data filer, the KROSS will have less than the required time to write the data into memory, and will be unable to receive all of the data correctly.

Receiving SysEx data dumps

- Do not touch the KROSS's switches or turn off the power while SysEx data is being received.
- Before receiving data, close any dialog box, PAGE menu, or function.
- After a data dump is received, the KROSS will require approximately one second to process the data and write it into memory. During this time, the display will show the message, "Now writing into internal memory." While this message is shown, under no circumstances should you turn off the power of the KROSS. If the power is turned off during this time, the KROSS may fail to operate correctly when the power is turned on again. In this case, hold down the EXIT button together with PAGE button, and turn on the power. However, this will initialize the contents of memory.
- Transmission and reception of any other MIDI data is also impossible during this time. When receiving multiple data dumps in succession, you must allow enough time between each data dump for the message to disappear from the screen.
- MIDI cannot be transmitted or received while data is being written into internal memory. Also, transmission of Active Sensing (FEh) from the MIDI OUT connector and USB connector will be halted.

Receiving a data dump

1. **Connect the KROSS with the device that will transmit the data dump.**

If you're transmitting data from a computer, connect the KROSS's USB connector to your computer's USB connector.

If you're transmitting data from another KROSS or from a MIDI data filer, connect the target KROSS's MIDI IN connector to the MIDI OUT connector of the transmitting device.

2. **Set the MIDI channel of the transmitting device to match the KROSS's global MIDI channel MIDI Channel (G-MIDI> BASIC).**

If you want the KROSS to receive data that was previously transmitted to a MIDI device, you must set the global MIDI channel of the KROSS to the same global MIDI channel that was used when the data was transmitted.

To set the MIDI channel of the transmitting device, please see the owner's manual for that device.

3. **In the G-MIDI> FILTER page, select the Enable Exclusive check box.**

When one of these functions is displayed, data dumps can be received regardless of the Enable Exclusive setting.

4. **Transmit the data from the other device. For the procedure, please see the owner's manual for the device you are using.**

Copy Scale

Copy Scale is available on the Scales page.

This function copies data from a preset scale to a user scale or copies a user scale to another user scale location. For details on the preset scales, please see "Scale Type" on page 10.



1. **Use the From field to select the copy-source scale.**

If you select Pure Major or Pure Minor, specify the **Key** (located at the right) as well.

Stretch cannot be selected if **To** is User All Notes Scale.

2. **In To, selects the copy destination scale.**

Write Arpeggio Patterns

Write Arpeggio Patterns is available on the APR PATTERN pages.

This function writes user arpeggio patterns 0000–1027.

Pattern, ♩ (Tempo), Octave, Resolution, Sort, Latch, Sync (Key Sync), and Kbd (Keyboard) are parameters that are set in Program, Combination, and Song. The Write operation executed here does not save these parameters.

If you move here from Program or Combination mode and set these parameters, you must return to the original mode and write them.

Rename Arpeggio Pattern

Rename Arpeggio Pattern is available on the ARPEGGIATOR pages.

This function renames the selected user arpeggio pattern.

Preset patterns UP-RANDOM cannot be renamed.

For more information, please see "Editing names" section on page 105 of the Operation Guide.



Copy Arpeggio Pattern

Copy Arpeggio Pattern is available on the ARPEGGIATOR pages.

This function copies the settings of another user arpeggio pattern to the currently selected arpeggio pattern.

It is not possible to copy from a preset arpeggio pattern UP-RANDOM.



Select the copy source arpeggio pattern **From**.

⚠ Be aware that when you execute **Copy Arpeggio Pattern**, all settings of the currently selected arpeggio pattern will be overwritten.

Initialize Steps

This function initializes the step parameters (**Tone, Pitch Offset, Gate, Velocity, Flam**) of the arpeggio pattern.

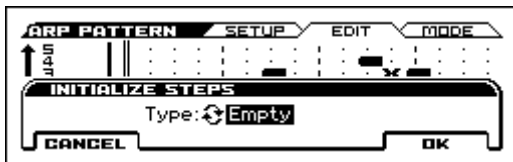

Type: Empty will initialize all tones to a blank state.

Type: Full will initialize all tones to a full state.

Copy Step

This function copies the settings of a specific step. The settings of two or more adjacent steps can also be copied together.

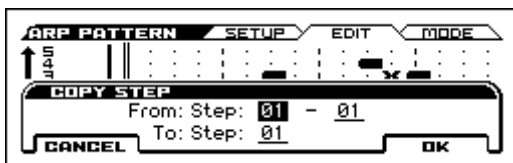

1. In “**From Step**”, select the range of steps that you wish to copy.

2. In “**To Step**,” select the copy destination step.

If you selected more than one step in **From Step**, the steps will be copied starting at **To Step** and continuing through the steps to the right.

Delete Step

This function deletes the step parameters (**Tone, Pitch Offset, Gate, Velocity, Flam**) of the currently selected step number. Subsequent steps will move one column toward the left.

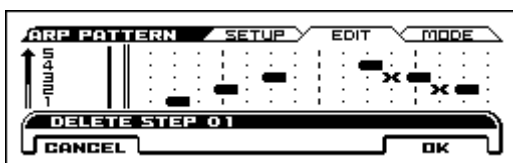

Insert Step

This function inserts an empty step into the currently selected step number. Subsequent steps will be moved one step to the right.

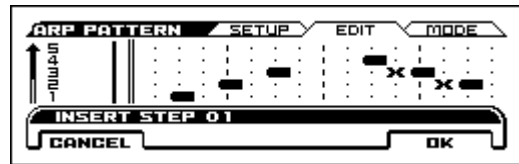

Rotate Step

This function rotates the step settings.

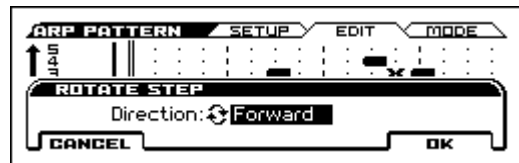

For example, suppose there is a pattern of **Length 4**.

If you select **Forward**, the settings of Step 1 will be rewritten to 2, Step 2 → 3, Step 3 → 4, Step 4 → 1.

If you select **Backward**, the settings of Step 1 will be rewritten to 4, Step 2 → 1, Step 3 → 2, Step 4 → 3.

Write Drum Kits

Write Drum Kits is available on the DRUMKIT pages.

This saves all drum kits 00 (INT)–47 (USER).

You must write an edited drum kit if you want to keep it. Edited drum kits cannot be recovered if you turn off the power before saving them.



Rename Drum Kit

Rename Drum Kits is available on the DRUMKIT pages.

This renames a drum kit.

For more information, please see “Editing names” section on page 105 of the Operation Guide.



Copy Drum Kit

Copy Drum Kits is available on the DRUMKIT pages.

This function copies the settings of another drum kit to the currently-edited drum kit.

Note: Drum kits 48 (GM)–56 (GM) cannot be edited, but you may copy them to another drum kit and then edit them.



Select the copy source drum kit (**From**).

⚠ When you execute **Copy Drum Kit**, the settings of the currently selected drum kit will be overwritten.

Copy Key Setup

Copy Key Setup is available on the DRUMKIT pages.

This function copies the settings of an individual key to another key. You can also copy settings from two or more contiguous keys at once.



1. In the “From Key” fields, select the range of keys that you wish to copy.
2. In the “To Key” field, select the copy destination key.

If you selected two or more keys in the **From Key** field, their settings will be copied to the keys starting at the **To Key** and continuing upward.

Swap Key Setup

Swap Key Setup is available on the DRUMKIT pages.

This function exchanges (swaps) the settings of one key with the settings of another key.



Use **Source Key 1** and **Source Key 2** to specify the keys whose settings you want to swap.

Load selected

Load selected is available on the MEDIA> FILE page.

This loads the file or directory selected in the directory window into the internal memory.

1. In the directory window, select the file or directory that you want to load.
2. Select **Load selected**.

A dialog box will appear. The dialog box that appears will depend on the file you are loading. Specify the various items as necessary.

1) Load .PCG

Data in the .PCG file will be loaded.

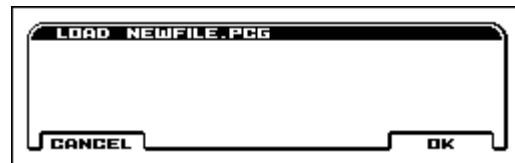

2) Load Programs

All program data from a .PCG file will be loaded.

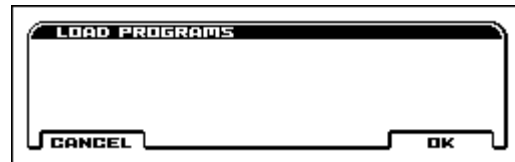

3) Load Program Bank

All program data from the selected bank will be loaded into the bank you specify.

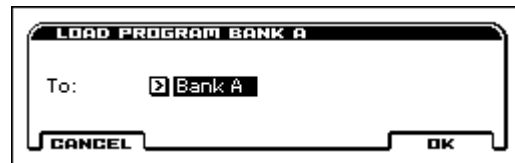

In To, select the loading destination bank.

⚠ The load-destination can only be bank U or the same bank as the load-source bank.

4) Load a Program

Data for the selected program will be loaded into the program number you specify.



1. If you wish to load a program other than the one already selected, use the “From”(upper field) to select the program that you wish to load.

Note: The selected program can be played from the keyboard even before you load it. This is convenient when you want to audition the program before loading. For more information, please see the “PCG Preview” section on page 175.

2. In “To”, (lower field) select the bank and program where the data will be loaded.

⚠ The load-destination can only be bank U.

5) Load Combinations

All combinations in the .PCG file will be loaded.

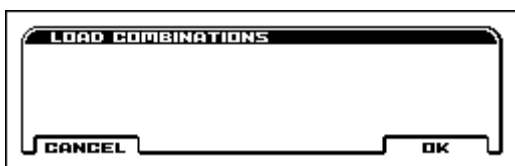
**6) Load Combination Bank****[Bank A...D]**

All combinations in the selected bank will be loaded into the bank you specify.

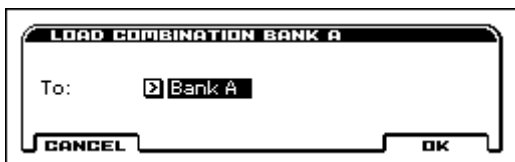

In To, select the loading destination bank.

- ⚠ The load-destination can only be bank U or the same bank as the load-source bank.

7) Load a Combination

This loads the selected Combination into a specified Bank and number in internal memory.

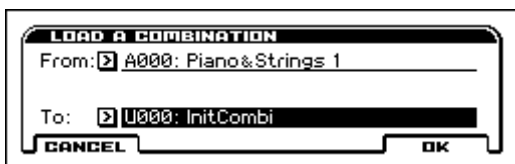

1. If you wish to load a combination other than the one already selected, use "From" (upper field) to select the combination that you wish to load.

Note: The selected combination can be played from the keyboard even before you load it. This is convenient when you want to audition the combination before loading it. For more information, please see the "PCG Preview" section on page 175.

2. In "To" (lower field), select the bank and combination where the data will be loaded.

- ⚠ The load-destination can only be bank U.

8) Load Drum Kits

All drum kits in the .PCG file will be loaded.

**9) Load Drum Kit****[000-031(INT), 032-047(USER)]**

This function loads all drum kit data from the selected drum kit bank into the drum kit bank that you specify as the load-destination.



In To, select the loading destination bank.

- ⚠ If you've selected (USER) as the load-destination for the selected drum kit bank (INT), 000-015 will be loaded. If you've selected (INT) as the load-destination for (USER), the data will be loaded into 000-015.

10) Load a Drum Kit

The selected drum kit will be loaded into the drum kit number you specify as the loading destination.

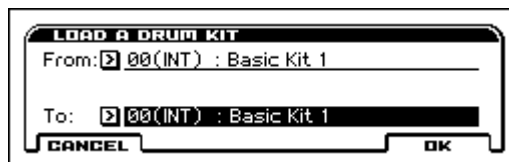

1. If you wish to load a drum kit other than the one already selected, use "From" (upper field) to re-select the drum kit you wish to load.

Note: The selected drum kit can be played from the keyboard even before you load it. This is convenient when you want to audition drum kits before loading. For more information, please see the "PCG Preview" section on page 175.

2. In To "To" (lower field), select the loading destination drum kit.

11) Load Arpeggio Patterns

All user arpeggio pattern data in the .PCG file will be loaded.

**12) Load Arpeggio Pattern****[U0000...0915(INT), U0916...1027(USER)]**

All user arpeggio pattern data in the selected user arpeggio pattern bank will be loaded into the user arpeggio pattern bank you specify as the loading destination.



In To, select the loading destination user arpeggio pattern bank.

If you execute this function with U0916-1027(USER) specified as the loading destination for the selected user arpeggio pattern bank 0000-0915(INT), user arpeggio patterns 0000-0127 will be loaded. If you select 0000-0915(INT) as the loading destination for U0916-1027(USER), the data will be loaded into user arpeggio patterns 0000-0111.

13) Load an Arpeggio Pattern

The selected user arpeggio pattern data will be loaded into the user arpeggio pattern number that you specify as the loading destination.

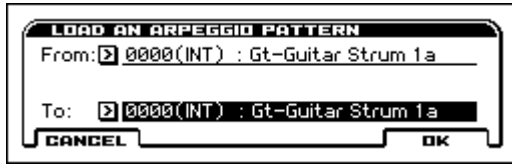

1. If you wish to load a user arpeggio pattern other than the currently selected one, use “From” (upper field) to re-select the user arpeggio pattern that you wish to load.

The selected user arpeggio pattern can be played from the keyboard even before you load it. This is convenient when you want to audition the user arpeggio pattern you wish to load.

2. In “To” (lower field) specify the loading destination user arpeggio pattern.

14) Load Global Setting

Global setting data in the .PCG file will be loaded.

This includes Global mode parameters other than drum kits and arpeggio patterns.

- Memory protect and Effect Global SW settings will not be loaded.

15) Load .SNG

All data in the .SNG file will be loaded.

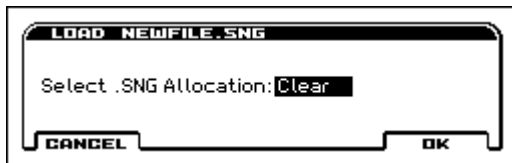

Use Select .SNG Allocation to specify how the song data from the .SNG file will be loaded.

Append: The song will be loaded after the last song data that already exists in internal memory. At this time, the song data in the .SNG file being loaded will be packed forward. (See diagram below)

Select this when you want to add song data from media without erasing the song data that currently exists in internal memory.

Clear: All song data currently existing in internal memory will be erased, and song data will be loaded in the state in which it was saved (See diagram below).

Select this when you want to reproduce the saved state immediately after power-on, etc.

.SNG Allocation

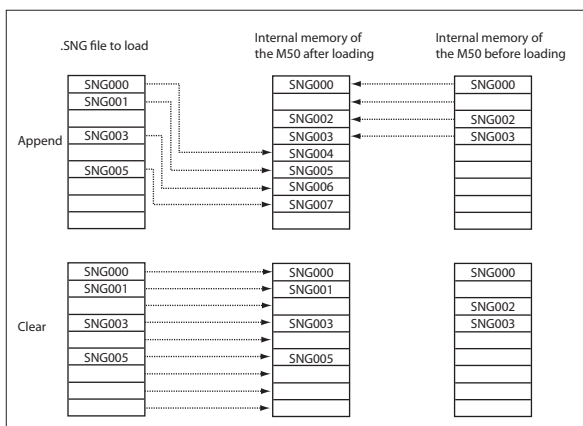

16) Load a Song

Data for the selected song will be loaded into the song number you specified as the load destination.



1. If you wish to load a song other than the selected song, use “From” (upper field) to re-select the song to be loaded.
2. In “To” (lower field), select the loading destination song.

17) Load Tracks

The event data of all tracks in the selected song will be loaded into the song you specify as the loading destination. However, it is not possible to specify an uncreated song as the loading destination.



In Song, specify the loading destination song.

18) Load Standard MIDI File

The selected Standard MIDI File will be loaded into the song number you select as the loading destination.



In To, select the loading destination song.

Note: Any System Exclusive messages or Universal Exclusive messages included in the SMF data will not be loaded.

If this is On (checked), System Exclusive messages and Universal Exclusive messages included in the SMF data will be loaded as System Exclusive events.

- The GS/XG sound maps and messages are not supported. Depending on the contents of the data, there may be cases in which it will not play back correctly.

If you select an undefined file and choose **Load selected**, the file will be assumed to be a Standard MIDI File, and the **Load Standard MIDI File** dialog box will appear. When you execute loading, the file will be loaded into the song that was specified as the loading destination. However if the file format is inappropriate, the operation will be invalid and an error message will be displayed.

The program bank and program numbers loaded into the song will follow the **Bank Map** (GLOBAL> PEF) setting. If **Bank Map** is KOR, bank A will be selected for bank select 00.00 (MSB. LSB). If **Bank Map** is GM(2), bank G will be selected.

19) Import WAV

This function imports a WAVE file into the audio recorder.

You can import a WAVE file into the audio recorder, and play it or overdub onto it

- File format: WAVE format uncompressed linear PCM
- Sample bit depth: 16-bit
- Sampling frequency: 44.1 kHz or 48 kHz, stereo files
- Number of characters in file name: The first eight characters are shown

Note: Since 44.1 kHz WAVE files will be converted into 48 kHz as they are imported into the KROSS, a small amount of time may be required.



The number following the last song of the audio recorder is automatically selected as the load-destination.

1. If necessary, assign a name to the audio song.

see page 105 of the Operation Guide

2. Use Level Adjust to compensate the volume.

You can compensate the volume in a range of -96+96.

3. If you decide to stop mid-way through the Load procedure, press ABORT.

Cautions regarding Save

If the data being saved does not fit on one volume of media

When saving a .PCG, or .SNG file, and the data does not fit on one volume of media, the display will read “No space available on media”.

Either delete unneeded files to create free space on the media before saving, or save the data to other media.

Save All (PCG & SEQ)

Save All (PCG & SEQ) is available on the MEDIA> FILE page.

This function saves all programs, combinations, drum kits, global settings, favorites, and user arpeggio patterns from internal memory to media as a .PCG file. Songs are saved to media as a .SNG file.

This function is valid only when the current directory is a DOS directory.

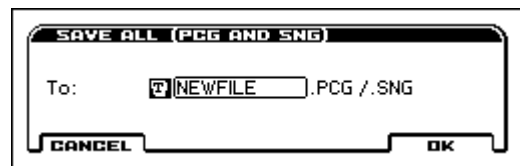

Enter a name, and execute the Save operation. (For details on how to rename, see page 105 of the Operation Guide.)

For example, if you specify NEWFILE and execute the save function, files named NEWFILE.PCG, and NEWFILE.SNG will be saved to the media.

When you save, files will be created in the current directory.

Save PCG

Save PCG is available on the MEDIA> FILE page.

This function saves all programs, combinations, drum kits, global settings, and user arpeggio patterns from internal memory to media as a .PCG file.

This function is valid only when the current directory is a DOS directory.

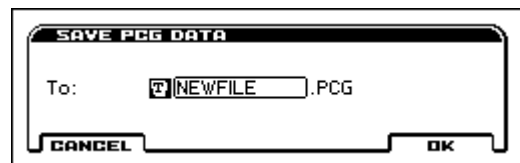

Enter a name, and execute the Save operation. (For details on how to rename, see page 105 of the Operation Guide.)

For example if you specify NEWFILE and execute the save operation, files named NEWFILE.PCG and NEWFILE.SNG will be saved to the media.

Save SEQ

Save SEQ is available on the MEDIA> FILE page.

This function saves all songs from internal memory as a .SNG file.

This function is valid only when the current directory is a DOS directory.

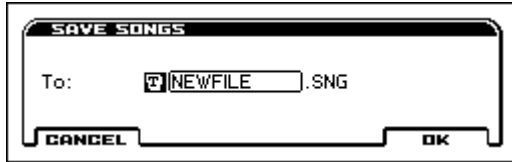

Enter a name, and execute the Save operation. (For details on how to rename, see page 105 of the Operation Guide.)

For example, if you specify NEWFILE and execute the save function, a file named NEWFILE.SNG will be saved to the media.

Save to Standard MIDI File

Save to Standard MIDI File is available on the MEDIA> FILE page.

This function saves the selected song from internal memory to storage media as a .MID file (Standard MIDI File).

This function is valid only when the current directory is a DOS directory.



1. In **Song**, choose the song that you wish to save.
2. Specify the filename. (see page 105 of the Operation Guide)
By default, the first eight characters (uppercase) of the song name will be assigned automatically.
3. Use the “Format” field to specify the format.

Format 0 will save sixteen channels of MIDI data together in a single track.

Format 1 will save each MIDI channel to a separate track.

The song data that you save here can be played back on a device that supports Standard MIDI Files. However if you intend to play back the data on the KROSS, we recommend that you use “Save SEQ” to save the data, since this will be more easily recreated.

Rename

Rename is available on the MEDIA> UTILITY page.

This function renames the selected file or directory.

This function is valid only when a DOS file or a DOS directory is selected.

1. Select the file or directory whose name you want to edit.
2. Select “Rename” to open the dialog box.

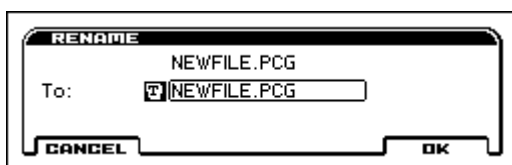

3. Press the ENTER button to access the text input dialog box, and edit the name. (see page 105 of the Operation Guide).

Delete

Delete is available on the MEDIA> UTILITY page.

This function deletes the selected file or directory.

This function is valid only if a DOS file or directory is selected.

1. Select the file or directory that you want to delete.
2. Select “Delete” to open the dialog box.

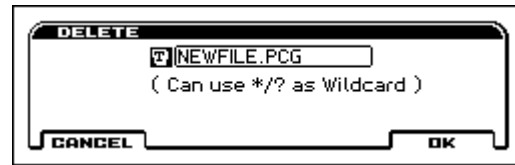

3. Delete will indicate the name of the selected file or directory.

If you wish to change the file or directory that is to be deleted, press the ENTER button to access the text input dialog box, and specify the name of the file or directory that you wish to delete. (see page 105 of the Operation Guide)

Using [*/?] as a Wildcard: When you use the text edit button to access the text input dialog box and specify the name of the file to be deleted, you can use the “*” or “?” characters as wildcards. This allows you to simultaneously delete multiple files with identical filenames and different extensions.

⚠ When wildcards are used, only files will be subject to deletion. Directories will not be deleted.

Format

Format is available on the MEDIA> UTILITY page.

This function formats the media that's inserted in the KROSS. The volume label (a name for the entire media) you specify will be assigned to the media. The volume label you assign here will be displayed in the SD Card (MEDIA> FILE). The volume label can be a maximum of eleven characters.

1. Make sure that the media you want to format is inserted.
2. Select the “Format” field to open the dialog box.

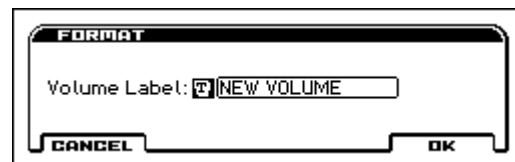

3. In **Volume Label**, specify the volume label name (see page 105 of the Operation Guide).

The previously-specified volume label will be displayed. If no volume label had been specified for the media, or if a non-DOS media was inserted, this will indicate **NEW VOLUME**.

Set Date/Time

Set Date/Time is available on the MEDIA> UTILITY page.

This is the date and time when the file was saved.

-  The KROSS does not contain an internal calendar or clock, you must use Utility menu function **Set Date/Time** to set the date and time before saving the file.

Year	1980–2079
Month	1–12
Day	1–31
Hour	0–23
Minute	0–59
Second	0–59

Favorites

About the Favorites function

The Favorites function is a convenient way to register sounds or audio songs for quick recall. You can register not only internal sounds, but also register MIDI bank select and program change messages to recall sounds on an external device.

-  If you want to keep the registrations and settings that you made for the Favorites function, you must save them before you turn off the power. To save these settings, execute the Write Favorites function. (see page 189)

What you can register in Favorites

You can register the following as Favorites.

Sound bank and number

- Internal (program or combination)

or

- External (MIDI bank select and program change)

Note: If you specify External, the internal sound engine will not produce sound. If you want to simultaneously recall both an internal sound and a sound on an external sound module, specify Internal and use a combination where you've specified EXT or EX2 settings.

Audio song number

Registering a sound

Registering the currently selected sound

1. Select a program or combination
2. Hold down the EXIT button and press the FAVORITES button
3. Use the BANK button to select a Favorites bank.
4. Press one of the 1–16 buttons to register the sound to that button

Note: You can also register by using the Add to Favorites function.

Editing a favorite to change the registered content

1. Turn on the Favorites function
2. Select the favorite that you want to edit
3. Press the ENTER button to access the Edit Favorite dialog box, and change the sound

Note: You can also access this from the Edit Favorite function.

Registering an audio song

Editing a favorite to change the registered content

1. Turn on the Favorites function
2. Select the favorite that you want to edit
3. Press the ENTER button to access the Edit Favorite dialog box, and specify an audio song number

Note: You can also access this from the Edit Favorite function.

Selecting a favorite

You can select a favorite in any of the following ways.

Note: Turn on the FAVORITES button before you proceed.

Using the front panel

- Use the BANK button to select a Favorites bank, and press one of the 1–16 buttons to select a favorite.
- Use the value dial or cursor buttons ◀▶.

Using a foot switch

- Assign the foot switch to Value Inc/Dec or Program Up/Down, and use it (G-INPUT/CTRL> FOOT see page 164)

Using MIDI

- Receive a MIDI program change to select a favorite

Favorites and MIDI

Each favorite is assigned its own number, as follows. Normally when you use the Favorites function, these numbers are used to transmit or receive a MIDI program change.

Favorite No.	Prog Chg No.
A01–A16	0-15
B01–B16	16-31
C01–C16	32-47
D01–D16	48-63

Transmission

When you select a favorite, the above number will be transmitted as a MIDI program change.

However if you select a favorite that is registered as External, the above number will not be used; instead, the bank and number you specified will be transmitted as MIDI bank select and program change messages.

Reception

If the Favorites function is on, the KROSS will switch to the corresponding favorite when it receives one of the above program changes.

FAVORITES-A, B, C, D

0-1: 1-4, 5-8, 9-12, 13-16



The 64 favorites are organized into four banks, each bank displayed as four tabs each containing four favorites (1-4, 5-8, 9-12, 13-16). When you select a favorite, you'll switch to the page that contains that favorite; a triangle will appear to the left of the selected favorite, and its bank and number will be highlighted.

By using the PAGE+/- buttons, you can view other pages without switching favorites. This is a convenient way to check the sounds that are registered as favorites. Press the EXIT button to return to the page that includes the currently selected favorite.

Tip: You can use the page menu to directly select the page that you want to see. (see "Selecting pages and tabs" on page 11 of the Operation Guide)

Favorites Bank, No.

[A01...A16, B01...B16, C01...C16, D01...D16]

This shows the bank and number of the favorite. The bank and number of the currently selected favorite are highlighted.

Favorite Information

This shows the settings that are registered as a favorite.

If Select is set to Internal in the Edit Favorite screen, the registered program or combination, the bank and number, the category icon, and name are shown.

If External MIDI is selected, the MIDI transmit channel, audio song number, EXT icon, bank select MSB and LSB, and program change number are shown.

✓ 0-1: FUNCTION

- 0: **Write Favorites** see page 189
- 1: **Edit Favorite** see page 189
- 2: **Copy Favorite** see page 189
- 3: **Insert Favorite** see page 189
- 4: **Delete Favorite** see page 189

Favorites: Function

For details on how to select each function, see “Selecting and executing functions” on page 13 of the Operation Guide

Write Favorites

- Be sure to save the favorites settings that you want to keep. The edited favorites settings cannot be recovered if you turn off the power before saving them.

This function saves all favorite settings in internal memory.

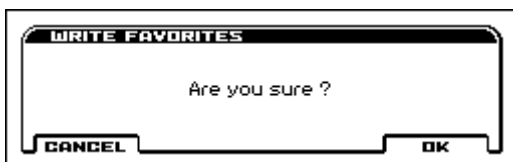

Edit Favorite

This function lets you edit the settings of the selected favorite. “Select” specifies whether the favorite will be a sound (a program or combination) of the internal sound generator, or a sound of an external device.

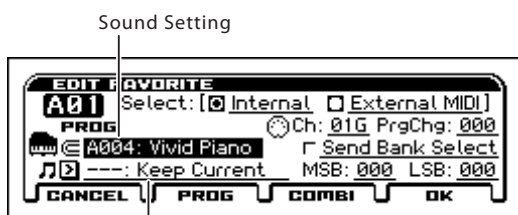

Select: Internal

The registered program or combination will be enabled. Use this setting when you want to use the keyboard of the KROSS to play a program or combination.

If the Favorites function is on, pressing a button 1-16 will transmit a program change on the global MIDI channel. (see “Favorites and MIDI” on page 187)

Select: External MIDI

Ch: The external MIDI device will be controlled on the MIDI channel that you specify here. If the Favorites function is on, pressing a button 1-16 will transmit the following settings on the MIDI channel specified by “Ch.”

PrgChg: MIDI program change

Send Bank Select: If this is checked, the bank select messages specified by MSB and LSB will be transmitted. If this is not checked, bank select messages will not be transmitted.

Sound Setting

This specifies the sound that will be played if Internal is selected. You can use the PROG or COMBI buttons to switch the mode that's used.

Audio Recorder Setting

Registers an audio song number as a favorite. By pressing the PLAY/PAUSE (▶/||) button you can audition the currently selected audio song.

When you recall an audio song, the beginning of the song will be specified automatically. Playback will stop if you recall a different audio song while the audio song is playing.

000...199: Specifies the number of the audio song to be recalled. The song name is shown at the right of the number. Numbers with the indication “Not Found” do not contain an audio song.

---: Keep Current: The current settings of the audio recorder will be maintained; no song will be recalled.

OK, CANCEL

Press the OK button to register the settings; the edit dialog box will close.

Copy Favorite

This function copies the selected favorite to the clipboard, holding it temporarily.

Insert Favorite

This function inserts the favorite that you copied to the clipboard in front of the selected favorite.

Note: All favorites existing after the position where you inserted will be moved back one space within that bank. The favorite at the last position in the bank (16) will be deleted.

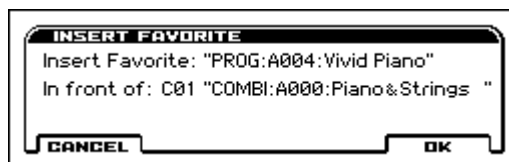

Delete Favorite

This function deletes the selected favorite.

Note: All favorites existing after the one you deleted will be moved forward one space within that bank. The last position in the bank (16) will become an initialized favorite.

If you execute this function with the All Favorites check box selected, all favorites will be deleted, and will become initialized favorites.



Audio Recorder

Overview of the audio recorder function

- This is a high-quality digital audio recorder that records onto an SD card inserted into the KROSS.
- The audio recorder gives you an easy way to record your phrases and ideas anytime you're playing, regardless of the sound or mode (except for Media mode).
- You can record up to 200 songs, and each song allows up to three hours of recording.

* The actual total time for a multi-track recording will depend on the free capacity of the SD card.

A single pass of recording will store approximately 11 MB of data per minute. This means that 1 GB allows you to record approximately 90 minutes. When you perform multi-track recording, additional data will be stored on the SD card according to the length of the recording. These recording times are approximate. Since song management data is also stored, the actual recordable time may be shorter depending on the number of songs.

- In addition to recording the sound of what you play on the keyboard or play back from the sequencer, the audio recorder can also record an external audio source such as a mic, guitar, or from an audio player that's connected to the KROSS.

In addition, you can play back the recorded audio while mixing your performance on the KROSS or another external audio source, and overdub as many times as you like.

- The insert/master effects that you use with programs etc. can also be inserted to process the external audio source while you record.
- Loop-playback is available.
- The recorded audio data is in PCM audio format (48 kHz/16-bit, stereo).
- By exporting the recorded audio data to the SD card as a WAVE file (48 kHz, 16-bit), you can use it with your computer.

You can also play an imported WAVE file (44.1 kHz/16-bit*, 48 kHz/16-bit, stereo).

* 44.1 kHz is automatically converted to 48 kHz.

 If the SD card is being used by the KROSS for the first time, you'll need to format it in GLOBAL/MEDIA mode. (see "Formatting SD card" on page 108 of the Operation Guide)

Note: When using an SD card with the KROSS for the first time, KORG/KROSS/AUDIO and DATA folders will be created automatically to make the card usable by the KROSS.

 Never remove the SD card during recording or playback. Doing so may temporarily destabilize the KROSS.

Signal flow within the audio recorder

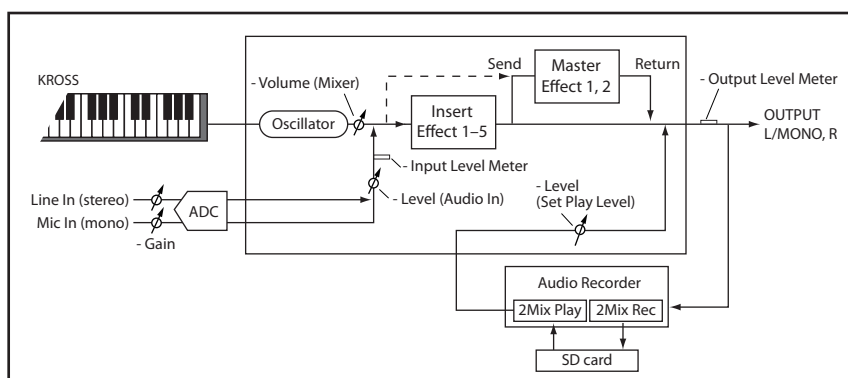

Recording control

Audio recorder transport operations such as record, play, and undo are performed using the front panel AUDIO RECORDER section SETUP button, ►/|| button, and the four buttons below the audio recorder dialog box that appears when you press the SETUP button.

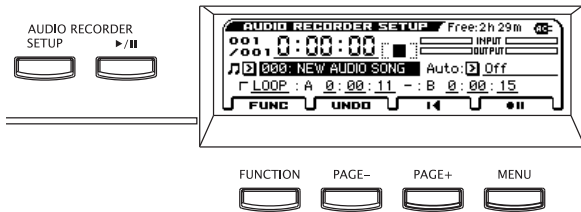

SETUP button

Accesses the audio recorder setup window.

PLAY/PAUSE (►/||) button

Controls recording, playback, and pause for the audio song. The operating status is shown by the color, and the state of the LED (lit or blinking). In each state, pressing this button will perform the following actions.

- LED unlit = Stopped: Press the button to start playback.
- Green LED blinking = Playback paused: Press the button to start playback.
- Green LED lit = Playing: Press the button to pause playback.
- Red LED blinking = Recording paused: Press the button to start recording.
- Orange LED blinking = Recording paused: Start recording by inputting the trigger specified by Auto.
- Red LED lit = Recording: Press the button to pause recording.

Audio Recorder Setup window

In this window you can control recording, stop, pause, and playback, as well as perform functions such as undo and create a new audio song. Use the buttons located below the display to control the recorder.

FUNC (FUNCTION) button

This button shows the function menu where you can use functions such as creating a new sound, renaming, deleting, exporting, or adjusting the level. (see page 195)

UNDO (PAGE-) button

Shows the UNDO dialog box. Here is where you can step back to an earlier recording take. You'll also use this button for the Redo function which brings back a recorded take. (see page 192)

Stop/Reset (PAGE+) button

This is the stop button. It stops playback or recording of the audio song. When you stop, the recorder will return to the stored location. If you press locate while stopped, you'll return to the beginning 0:00:00 of the song.

REC Control (MENU) button

This is the record button. It controls record-pause and record-start. The functionality of the button will depend on the current state. In each state, pressing this button will perform the following actions.

- ■■■ = While stopped: Press the button to enter the record-pause state.
- ■► = When shown: Press the button to start recording.
- ► = Recording: Press the button to switch to playback.

Foot switch

You can use a foot switch to switch between play/play-pause or record/record-pause (Foot SW Assign =Audio Recorder Start/Pause, Audio Recorder REC Start/Stop). (see page 293)

Audio recorder button operation list

Audio recorder button operation list

(When Auto=Off)

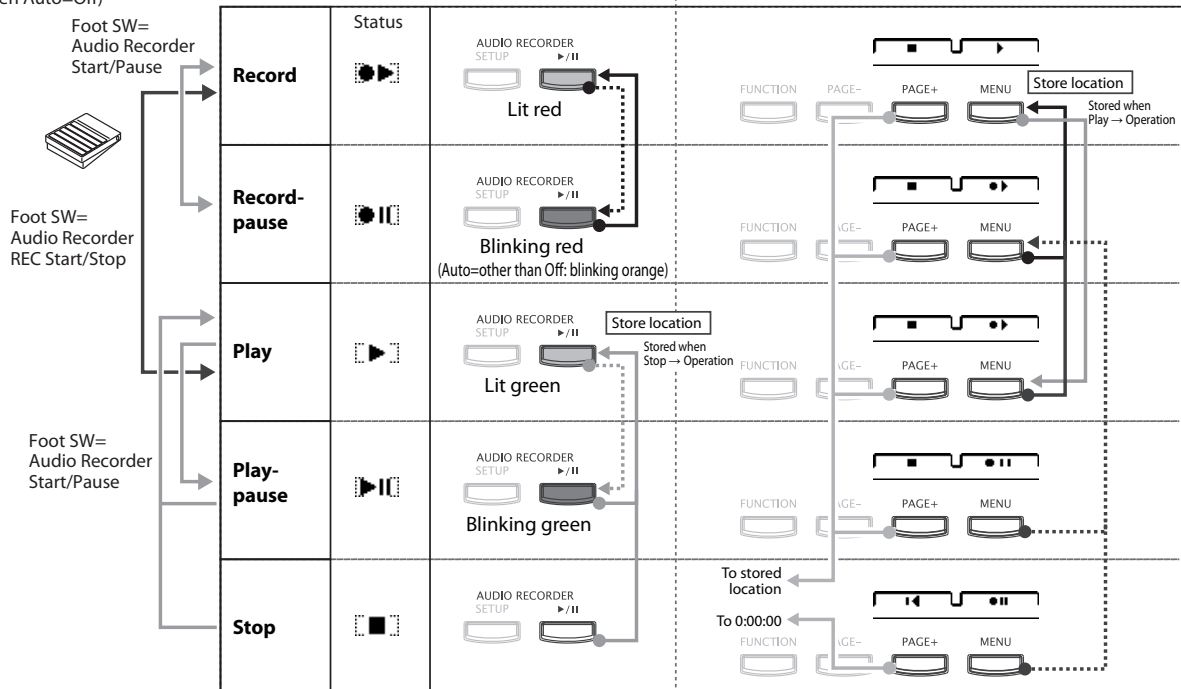

▶ (Other than when Auto=Off: Play while standing by for trigger-recording)

Recording procedure

1. Insert an SD card into the SD card slot
2. Select the source that you want to record
 - KROSS program, combination, or favorite
 - Sequencer song
 - Audio signal from the MIC IN jack or LINE IN jack (see page 5)
3. Press the AUDIO IN SETUP button
4. Press the Rec Control button to enter the record-standby condition
5. Press a key or the Rec Control button to start recording

* The recording start method will depend on the Auto setting (see page 194)

6. Press the Stop/Reset button to stop recording

For more information, please see “Recording and playing audio” on page 87 of the Operation Guide.

Audio Recorder Setup

In the audio recorder setup window you can adjust settings for the audio recorder.

- Press the AUDIO RECORDER SETUP button to open the window.

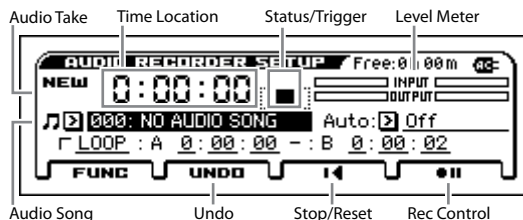

Audio Take [NEW, Currently No./Multi-track No.]

New: A state where no recording has occurred yet.

Currently No./Multi-track No.: When you record, the left side indicates the currently selected take, and the right side indicates the number of multi-track recordings. You can use Undo to go back to a previous recording.

Time Location [0:00:00...2:59:59]

Indicates the location within the audio song. From the left, this shows hours, minutes, and seconds.

During recording or playback, pressing the Stop/Reset (PAGE+) button will stop and take you back to the location where you started recording or playing (except if you started from pause).

When stopped, pressing the Stop/Reset (PAGE+) button will take you to the beginning (0:00:00) of the song.

If you want to move the location, use the cursor buttons ◀▶▲▼ to select Time Location, and press the ENTER button (the ▲▼ symbols are shown beside the value). Use the cursor buttons ▲▼ or the VALUE dial to specify the location, and press the ENTER button to move there.

You can't change the location during recording or in the record-pause state.

Status/Trigger

Indicates the state of the audio recorder, such as recording, playing, or stopped. Refer to Status in “Audio recorder button operation list” on page 192.

If Auto (Auto Rec Start) is set to something other than Off, this will indicate “TRIG.”

Level Meter

INPUT: Indicates the level of the external audio that's being input to the KROSS.

OUTPUT: Indicates the level of the sound being output from the L/R jacks (the sound of the KROSS, the external audio input, and the playback of the audio recorder). During recording, this will show the recording level.

Audio Song [000...199: Audio Song Name/Media Info.]

Selects a song.

Tip: To create a new audio song, use the “Create New Audio Song” function (see page 195).

The following messages related to the SD card are also shown.

NO MEDIA: No SD card is inserted.

UNFORMATTED: The format of the SD card could not be recognized.

NO AUDIO SONG: There are no audio songs.

Note: If the SD card is locked (write protected), a different error message “Write protected” will appear if you perform an operation that writes to the SD card, such as recording. (see “Error messages” on page 115)

Auto (Auto Rec Start)

[Off, Note-On, SEQ START, Input Low, Input High]

Specifies how recording will be started automatically.

Specify the operation that will initiate recording after you've pressed the Rec Control **■ ■** (MENU) button to enter the record-standby condition (the AUDIO RECORDER **▶/||** button: blinking orange).

Off: Press the Rec Control **■ ■** (MENU) button or the AUDIO RECORDER **▶/||** button to start recording.

Note-On: Recording will start when you play the keyboard.

SEQ START: Recording will start when you press the SEQUENCER PLAY/STOP (**▶ / ■**) button.

Input Low: Recording will start when the audio input level exceeds approximately -18 dB.

Input High: Recording will start when the audio input level exceeds approximately -6 dB.

Note: If you've specified Input Low or Input High, play back, and then press the Rec Control **■ ■** (MENU) button slightly before the location where you want to start overdubbing. You'll enter the record-standby condition (AUDIO RECORDER button: blinking orange), and the audio input from 0.2 seconds earlier than the moment you started recording will actually be recorded.

⚡ If you've specified Input Low or Input High, initiate recording slightly before the location where you want recording to begin.

Note: This Auto (Auto Rec Start) setting is linked with the Auto Rec Start setting of the GLOBAL> PREF page. The setting is remembered automatically.

LOOP

[Off, On]

There's a loop playback function that lets you repeatedly play a specified region (A–B) of an audio song.

On (checked): The A-B region will loop.

Note: The loop play on/off setting and the specified time are saved individually for each audio song.

⚡ It's not possible to record while LOOP has a check mark. Nor is it possible to add a check mark to LOOP during recording.

⚡ This setting will be saved to the SD card when you switch to a different audio song or when you turn off the power. If you remove the SD card immediately after select the setting, the setting will not be saved.

A

[0:00:00...2:59:56]

B

[0:00:03...2:59:59]

These specify the beginning (point A) and end (point B) of the region that will play repeatedly when Loop is on. From the left, this shows hours, minutes, and seconds. To specify the loop region, set the beginning (point A) and end (point B) of the loop.

Note: The interval between points A and B will be at least three seconds.

Tip: Move the cursor to A or B, and press the ENTER button during playback; the current time location will be specified as a point. If you use this method to specify the time location of a point, the location will be specified with an accuracy of within one second.

FUNC (FUNCTION) button

(see page 192)

Stop/Reset (PAGE+) button

REC Control (MENU) button

(see page 192)

UNDO (PAGE-) button

Shows the UNDO dialog box. Here you can step back to an earlier recording take. You'll also use this button for the Redo function which brings back a recorded take.

1. Press the UNDO (PAGE-) button.

The UNDO dialog box will appear.

2. Select a take number.

3. Press the OK button.

The take will be switched when the dialog box closes.

When you execute Undo, the UNDO button will be highlighted.

Note: If you record in this state, the Redo data will be lost and the UNDO button will return to its original appearance.



✓ 0-1: FUNCTION

- 0: **Create New Audio Song** see page 195
- 1: **Rename Audio Song** see page 195
- 2: **Delete Audio Song** see page 195
- 3: **Export** see page 195
- 4: **Set Play Level** see page 195
- 5: **Adjut Audio Level** see page 196

Audio Recorder: Function

Procedure for each function

1. Press the **FUNCTION** button to open the function list.
2. Adjust settings in the dialog box.

For details on the settings in each dialog box, refer to the explanation of each function.

Press the **OK** button to execute, or press the **Cancel** button if you decide not to execute.

Create New Audio Song

This function creates a new audio song.



Rename Audio Song

Here you can rename the selected song. A name of up to 24 characters can be input.

For more information, please see “Editing names” on page 105 of the Operation Guide.



Delete Audio Song

This function deletes an audio song.



All: All audio songs will be deleted.

Current: The currently selected audio song will be deleted.

Export

Exports (writes) a multi-track recorded audio song to the SD card as a WAVE file.

This lets you use your audio player to listen to an audio song produced on the KROSS, or to load the song into your DAW.

- File format: WAVE format uncompressed linear PCM
- Sample bit depth: 16-bit
- Sampling frequency: 48 kHz

Number of characters in file name: The first eight characters are shown



Audio Song No.: The audio song that will be exported. If you want to rename the file, use the text dialog box to enter a name.

Level Adjust [-96 dB...+00 dB...+96 dB]

Raises or lowers the volume of the WAVE file that will be exported.

When you press the **OK** button, the selected audio song will be exported as a WAVE file.

The WAVE file will be created in the KORG/KROSS/DATA folder of the SD card.

Note: Stop the audio song before you execute this function.

Note: This may take some time, depending on the length of the song.

Note: During execution, you can cancel by pressing the **ABORT** (**FUNCTION**) button.

Set Play Level

Temporarily lowers the playback volume of audio songs.

Note: This will change the volume of all audio songs. When you turn off the power, the volume will return to its previous setting.



Level [-42, -36, -32, -30, -28, -26...+00 dB]

Specifies the volume. This is an adjustment in dB units relative to the original volume. You can adjust this while the audio song plays.

If you lower the volume, the following message will appear.

NOTICE: Overdubbing with this Level setting will attenuate the sections of previous takes by the same amount. Use **ADJ. LVL** to adjust the Audio Song and avoid uneven audio levels.

If you want to save the song with its adjusted volume, press the **ADJ. LVL** button to execute the Adjust Audio Level function.

Note: Note: In the Adjust Audio Level dialog box, the Level Adjust value will automatically be set to the Level value that's specified in the Set Play Level dialog box.

Adjust Audio Level

Increases or decreases the volume of an audio song, and creates a separate song.

Note: This adjustment is for a single song.



Audio Song No.: The audio song that will be adjusted. If you want to rename the song, use the text dialog box to enter a name.

Level Adjust [-96 dB...+00 dB...+96 dB]

Increases or decreases the volume of the audio song that will be created.

When you press the OK button, the selected audio song will be created with the volume that you specified. The audio song whose level you adjusted will automatically be selected. At this time, the value after adjustment will be 0 dB.

Note: Note: The level adjustment will not be executed while the audio song is playing. Stop the audio song before you execute this function.

Note: This may take some time, depending on the length of the song.

Note: During execution, you can cancel by pressing the ABORT (FUNCTION) button.

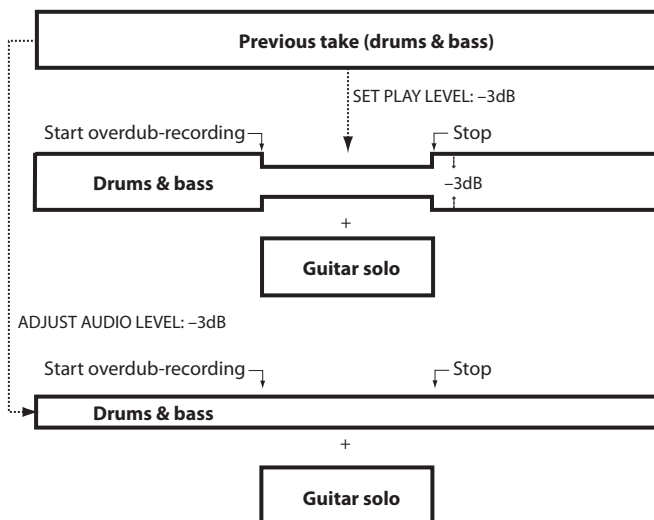

If you overdub-record the guitar solo with SET PLAY LEVEL left at -3 dB. The volume of the previous take (drums & bass) will be 3 dB lower for a portion of the recording, causing an unnatural result.

If you overdub-record the guitar solo after using ADJUST AUDIO LEVEL to lower the volume of the previous take by 3 dB. Unnatural volume changes will not occur in the previous take (drums & bass).

Effect Guide

Overview

The KROSS provides five insert effects, and two master effects, together with a mixer section that controls the routing of these effects.

For each of these effect processors, you can choose from 134 different types of effects, grouped into the following categories:

Classification of 134 effects

Effect type	Contents
Dynamics: 001–006	Effects which control volume, such as compressors, limiter, and gates
EQ/Filter: 007–019	Effects which control frequency content, such as EQ, multi-mode filter, exciter, and wah
Overdrive/Amp/Mic: 020–028	Overdrive and amp modeling effects such as guitar/bass amps and mics
Phaser/Modulation: 029–042	Pitch and phase modulation effects such as chorus and flanger
Mono - Mono Serial (Dyn/EQ/Phs): 043–061	Mono & Mono chain effects that internally connect two mono effects in series. Effects which control volume or control frequency, or phase modulation
Organ FX: 062–063	Organ effects
Chorus/Flanger/Pitch Mod: 064–081	Other modulation effects such as tremolo and rotary speaker, and pitch shifters
Mono - Mono Serial (Cho/Flng): 082–087	Mono & Mono chain effects that internally connect two mono effects in series. Pitch and phase modulation effects such as chorus and flanger
Delay: 088–104	Delay effect
Reverb/ER: 105–113	Reverb and early reflections
Mono - Mono Serial (Delay): 114–120	Mono & Mono chain effects that internally connect two mono effects in series. Delay effects.
Double Size: D00–D13 (121–134)	Double size effects

Effects in each mode

Program mode

With Programs, you can use insert effects to process the final sound in the same way that you use the Filter, Amplifier, and EQ (equalizer) to process the sound from the oscillators (OSC 1 & 2). You can also use insert effects on the Drum Track and the step sequencer.

Then the master effects are used to create overall ambience such as reverb to make final adjustments. All of these settings can be made independently for each program.

Combination, Sequencer mode

In Combination and Sequencer modes, you can use the insert effects to process the program sound of each timbre/track. You can then use the master effects to create overall ambience to make final adjustments.

In Combination mode you can adjust these settings for each combination, and in Sequencer mode you can make them for each song.

You can use the Copy From Program, Copy Insert Effect, or Copy Master Effect functions to copy effect settings from Program mode.

In Sequencer mode, you can switch between effects or modify the effect parameters and record these changes, so that effects will switch automatically or effect parameters will be modified automatically as the song plays back.

Note: The effect settings specified for a program are not recalled automatically when you select a program for a timbre in Combination mode or for a track in Sequencer mode. You'll need to adjust these settings separately, for example by using the functions listed above.]

Program mode

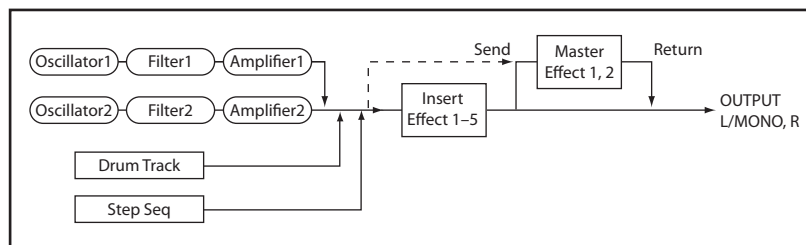

Combination, Sequencer mode

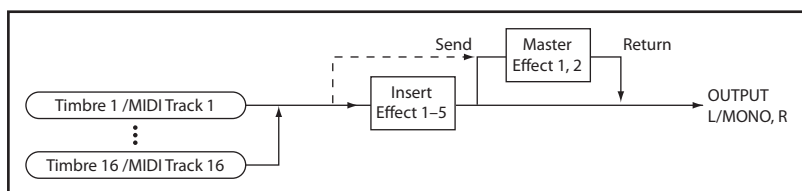

Dynamic modulation (Dmod) and Tempo Synchronization

Dynamic modulation (Dmod)

Dynamic modulation lets you control certain effects parameters in real-time, using either the built-in controllers or MIDI. These effect parameters are marked with the logo .

For more information, please see “Dynamic Modulation Sources (Dmod)” on page 380.

Tempo Synchronization

You can synchronize some effects parameters, such as LFO speeds and delay times, to the system tempo. This lets you sync the effects to Program LFOs, the Arpeggiator, the internal sequencer, or an external MIDI clock.

These effects parameters are marked with the logo .

Synchronizing LFOs

Most effects with LFOs, such as 011: St.Wah/Auto Wah, can be synchronized to tempo. This applies to the individual effects LFOs.

To set up LFOs to synchronize to tempo:

1. Set **MIDI Sync** to **On**.
2. Set the **BPM** as desired.

To synchronize to the system clock, set BPM to MIDI.

To set the LFO to a specific tempo, separate from the system clock, set BPM to the desired tempo (between 40.00 and 300.00 BPM).

3. Use the **Base Note** and **Times (x)** parameters to set the rhythmic value of the LFO.

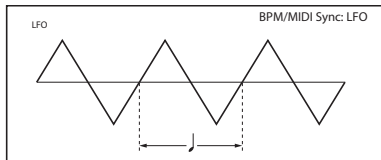

For instance, if you set **Base Note** to  and **Times (x)** to 2, each cycle of the LFO will last for a quarter-note (two eighth-notes).



Synchronizing Delay Times

Delays with “BPM” in their title will sync to tempo.

For instance, you might set up effect 102: Stereo BPM Delay for master effect 2 as follows:

1. Set **L Dly Note** to , and **Times (x)** to 4.
2. Set **R Dly Note** to , and **Times (x)** to 6.

In this case, the left channel delay time will correspond to four 32nd notes, and the right channel delay time will correspond to six 32nd notes.

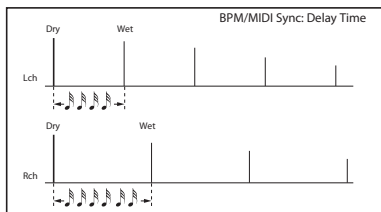

If the tempo, **Base Note**, and **Times** settings combine to exceed the maximum delay time, an indication such as “Time Over?: OVER” is displayed (only on the KROSS itself). Please adjust the settings so that this indication does not appear. (The maximum delay time will depend on the effect.)

Dynamic modulation to control an effect parameter in realtime

1. Enter Program mode, and select a desired program.
2. Access the P-MFX> SETUPpage.
3. Set **MFX2** to 099: L/C/R BPM Delay.
4. Turn on the MFX2, and increase the **Amt** value. Verify that the delay sound is being output.

Now, we can set the Dmod to change the delay level via the modulation wheel

5. In P-MFX>MFX 2 page, set “Input Lvl Dmod” to +100.
6. Set **Src** to **M.Whl #1**. The delay sound will disappear. The input level to the effect can be controlled by the modulation wheel. As you move the modulation wheel away from yourself, the delay sound will gradually increase.

Using a foot switch connected to the ASSIGNABLE SWITCH jack to vary the feedback level via Dmod

7. Connect a foot switch to the rear panel ASSIGNABLE SWITCH jack.
8. Access the GLOBAL mode G-INPUT/CTRL FOOT page, and set **Foot SW Assign** to **Foot Switch (CC#82)**.
9. Access the Program mode P-MFX MFX2 page, and set the L/R C BPM Delay parameter **Feedback Src** to **Foot #82** and **Amt** to +30.

When you move the modulation wheel away from yourself and press the foot switch, the feedback level will increase, and the delay sound will continue for a longer time. The “Amt” setting specifies the feedback level that will be in effect when the foot switch is pressed. If “Amt” is set to -10, pressing the foot switch will reduce the feedback level to 0.

Finally, we can use the MIDI/Tempo Sync function to synchronize the delay time to the arpeggiator tempo.

10. Set **BPM** to **MIDI**.

11. For L, C, and R, set the **Dly Note** and **Times** as desired.

For this example, set **Delay Base Note** to  and **Times** to x4 so that the effect will be easily understandable. The delay time will repeat at an interval of an 8th note.

12. Turn the TEMPO knob; the delay time will change.

When you (move the modulation wheel toward yourself and) press the foot switch, the feedback level will rise, and the delays will become longer.

13. When you turn on the ARP ON/OFF button, the arpeggiator will begin playing.

Select any desired arpeggiator. When you turn the TEMPO knob, the delay time will change in synchronization with the changing tempo of the arpeggiator playback.

Note: Depending on the specific delay effect, you may hear some unexpected noise if you change the TEMPO knob while the delay is sounding. This is because the delay sound becomes discontinuous, and is not a malfunction.

MIDI For some effects, you can synchronize the LFO frequency to the tempo. Set the effect parameters “MIDI Sync” to On, and BPM to MIDI. (see “Tempo Synchronization” on page 198)

FX Control Bus

The FX Control Buses let you create effects “sidechains.” Sidechains let you control an effect with one audio signal (the sidechain), while the effect processes a completely different audio signal.

This is convenient for use with vocoders and limiters, gates, etc. You can use a voice-type timbre to modulate a synth-type input to create rhythmic vocoder effects. Limiter or gate-type effects are often used to control an input using a different sound.

KROSS includes two true- stereo FX Control Buses, which can be used with the following effects:

Vocoder

D09: Vocoder

Limiter, and gate effects

S03: Stereo Limiter

S06: Stereo Gate

Example: Limiter (Combination)

Dynamics-type effects typically control the output level according to the level of the audio input signal. Some of the effects of the KROSS can control the output level using the signal of effect control buses 1 or 2, instead of the audio input.

The illustration below shows an example where the volume of a low-frequency range pad sound (Pad) is being lowered according to the volume of a high-frequency range guitar performance. The guitar sound (Guitar) is being output via insert effect 2 (IFX2) OD/Hi.Gain Wah, which is sent to the effect control bus 1 (FC1) so that the insert effect (IFX1) can detect its level and control the insert effect 1 (IFX1) Stereo Limiter which is the output of the pad-type sound (Pad).

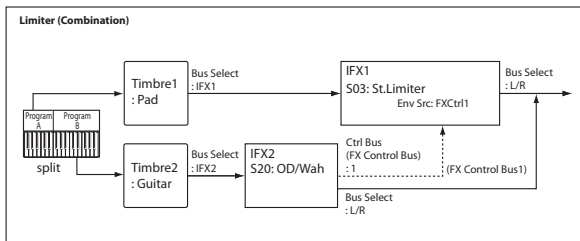

Example: Vocoder (Program)

A vocoder effect modulates the audio input (Carrier) by a separate audio input signal (Modulator), producing a distinctive effect. In the illustration below, the output of oscillator 1 (OSC1) and oscillator 2 (OSC2) is the carrier, and the audio input from a mic is being used as the modulator, creating the impression that the oscillators are “talking.” Send the carrier (OSC1 and 2) via “Bus” to insert effect 1 (IFX1); for the AUDIO INPUT mic input (modulator), choose effect control bus 1 (FC1) for “FX Control Bus,” and specify FX Control 1 as the “Mod Source” for IFX1: Vocoder.

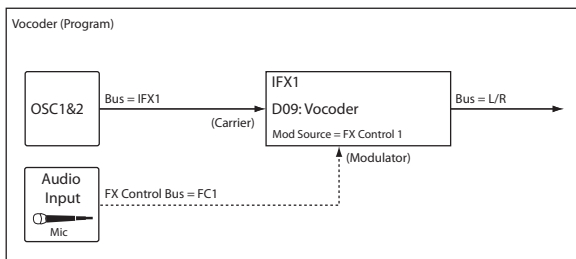

Example: Rhythmic Vocoder (Combination)

The vocoder is a unique effect that uses one audio signal (the modulator) to modulate another audio signal (the carrier). By using an arpeggiated drum pattern as the modulator, you can produce a rhythmic vocoder effect. As shown in the illustration, this example sends the drum pattern played by the timbre 2 arpeggiator to the FX Control bus and uses it as the vocoder’s modulator. For timbre 1 (the carrier), set **Bus** to **IFX1**, sending it to IFX1: vocoder. For timbre 2 (the modulator), set **FX Control Bus** to **FC1**, sending it to FX control bus 1. Set **IFX1: Vocoder’s Mod Src** to **FX Control 1** so that the arpeggiated drum pattern signal of timbre 2 will be the modulator for the vocoder.

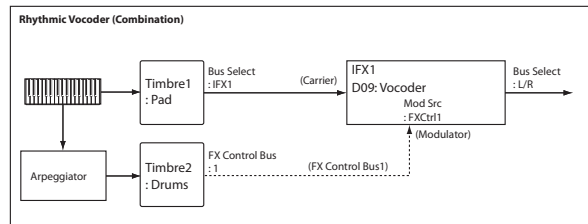

Effect I/O

For each effect, make the input signal level as high as possible without causing distortion.

For each effect, make the input signal level as high as possible without causing distortion. Also, use the Wet/Dry parameter for the Insert Effects and the **Wet/Dry** or **Return 1, 2** parameter for the Master Effects to adjust the effect output level.

If the input level is too low, the SN ratio may decrease. On the other hand, if the input level is too high, clipping may occur.

The following table shows the parameters related to the level settings:

Program mode

Input	OSC 1/2 Volume, Drum Track, Step Sequencer
	OSC 1/2 MS Level, Filter 1/2 Trim, Out, Amp 1/2 Level
	Send1/2
Output	Effect Trim parameter *
	Effect Wet/Dry parameter
	Return1, 2

Combination mode/Sequencer mode

Input	Volume
	Send1/2
Output	Effect Trim parameter *
	Effect Wet/Dry parameter
	Return1, 2

* Some effects may not have these parameters.

Insert Effects (IFX1–IFX5)

In/Out

Insert Effects (IFX 1–5) have a stereo input and a stereo output. If you set the Wet/Dry parameter to Dry (no effect), the input signal will be passed through, in stereo, without being processed by the effect. If you select Wet (effect applied), the processed signal will be output in one of the following ways:

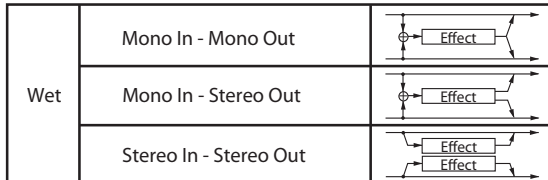

Input/output variations for each effect are shown on upper left of the block diagrams starting on page 207.

If you select 000: No Effect, stereo input signals are output in stereo without being processed.

In each mode, you can use IFX1–IFX5 On/Off to turn the effect on/off. If an effect is off, it will be bypassed. Just as when 000: No Effect is selected, the stereo input sound will be sent through as a stereo output.

MIDI The KROSS can also turn IFX1–IFX5 off separately from the setting of the On/Off by receiving MIDI control change message CC#92. Value 0 will turn them off, and value 1–127 will turn them on.

You can also use “Effect SW” (see page 157) to turn IFX1–5 on and off. This MIDI control is performed on the global MIDI channel (see page 159).

Double-size effects

Double-size effects (D00: St.Mltband Limiter–D13: Early Reflections) use twice the capacity of normal-size effects.

You can use double-size effects for insert effects IFX1–IFX4 and master effect MFX1. However, the effect of the number that follows it will be unavailable. For example if you’ve selected a double-size effect for IFX1, you won’t be able to use IFX2. If you’ve selected a double-size effect for MFX1, you won’t be able to use MFX2.

An example of when a double-size effect is selected for IFX1 and IFX4

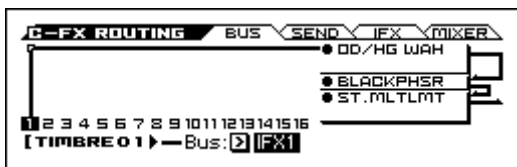

Routing

You can use up to five channels (IFX 1–5) for the Insert Effects in any mode.

Program mode

Use BUS page **Bus** to set the destination bus of the oscillator output.

L/R: Send the output to the L/R bus. Instead, it is sent to OUTPUT L/MONO and R after the MFX.

IFX1...5: The signal is sent to Insert Effects IFX 1–5.

Off: The output will not be sent to the L/R bus, or IFX1–5 buses. Choose the Off setting if you want to connect the oscillator output to a master effect in series. Use SEND page **OSC1 Send1**, **OSC1 Send2**, **OSC2 Send1**, and **OSC2 Send2** to adjust the send level.

The following illustration shows the output of oscillators 1 and 2 sent to IFX1.

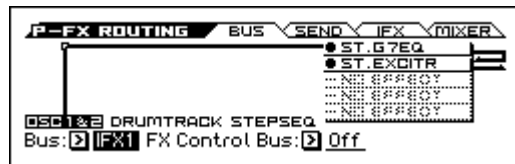

Use SEND page **OSC1 Send1**, **OSC1 Send2**, **OSC2 Send1**, and **OSC2 Send2** to specify the send level for the Master Effects. This setting is effective if **Bus** is set to **L/R** or **Off**.

If “Bus” is set to IFX1–5, use “Send1” and “Send2” (see page 59) to specify the send level of the post-IFX signal.

MIDI Send1 responds to CC#93, and Send2 responds to CC#91. At this time, the actual send level uses the value of the Send 1 and 2 settings for Oscillators 1 and 2, multiplied by the Send 1 and 2 values received via MIDI.

In the example shown in the next diagram, Oscillators 1 and 2 outputs being sent to IFX1.

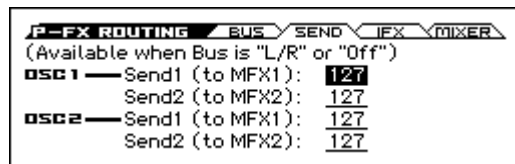

If you want to connect insert effects in series, turn IFX page “Chain” On and use “Chain To” to specify the chain-destination.

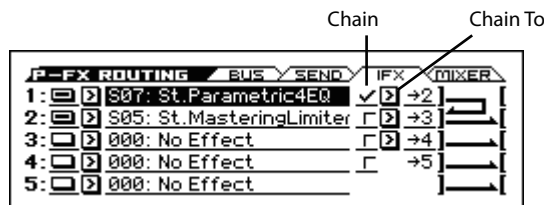

Effects can be chained only in ascending order of their number; for example IFX1 can be chained to IFX2 through IFX5, and IFX2 can be chained to IFX3 through IFX5. You can create a chain of up to five insert effects in series, IFX1 through IFX5.

When the Insert Effects are connected in series, the values of the “Pan(CC#8),” “Bus,” “Send1,” and “Send2” parameters for the post-IFX signal will be used.

In the following illustration, “Chain” is On and “Chain To” is set to the next IFX, creating a series connection of IFX1→IFX2→IFX3. The “Pan (CC#8),” “Bus,” and “Send 1” and “Send 2” settings after the signal has passed through IFX3 will be used.

Adjust these parameters in the MIXER page.

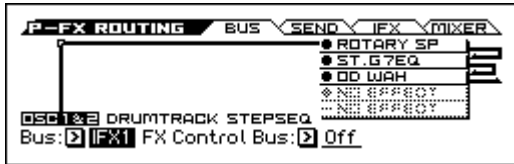

For a drum program

If the program's OSC (Oscillator Mode) is Drums, the screen indicates "DKIT-SET" as shown in the following illustration.

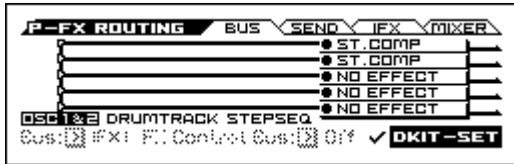

If this is On, the **Bus**, **FX Control Bus**, **Send1**, and **Send2** settings for each key of the currently-used drum kit are enabled.

For example, you can send a snare sound to IFX1 to apply the Gate effect, a kick sound to IFX2 to apply EQ, and other sounds to OUTPUT L/MONO and R without applying any Insert Effects.

Tip: In most of the preloaded drum kits, the following types of drum instrument have the same **Bus Select** settings.

Snare → IFX1

Kicks → IFX2

Cymbals → IFX3

Toms, Percussions, others → IFX4

If you de-select the box, all drum instrument outputs are sent to the bus specified by **Bus** (see page 59). You may apply any Insert Effects to all drum instruments, regardless of the DrumKit settings.

If this is Off, the output of all drum instruments will follow the **Bus** setting. This lets you apply an insert effect to all drum instruments, regardless of the settings of the drum kit.

Combination and Sequencer modes

Use "Bus" for timbres (Combination) and tracks (Sequencer) to select an Insert Effect to apply to the corresponding timbres and tracks. You can route multiple timbres and tracks to a single Insert Effect.

Tip: You can use each timbre/track's "Bus," post-IFX Chain to and "Chain" parameters to create a variety of routings.

Example: Inserting one IFX into two or more timbres

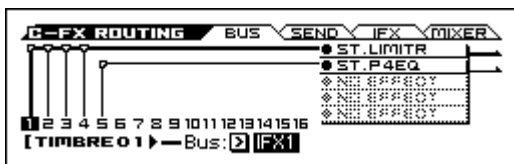

Example: Inserting a separate IFX into each timbre, and inserting another IFX later

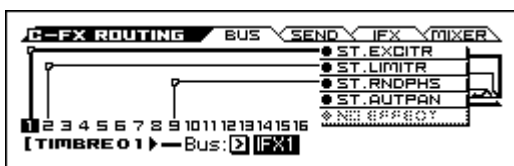

Example: Sharing part of a timbre's IFX chain with another timbre

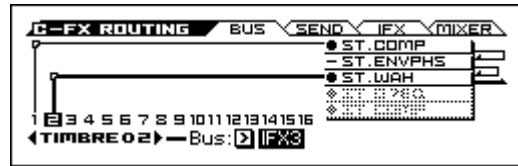

As with Program mode, select L/R, IFX1–5, or Off for each timbre and track.

SEND page "Send1" and "Send2" become available if "Bus" has been set to L/R or Off. If you've set "Bus" to IFX1–5, use "Send1" and "Send2" (see page 91, 132) following the insert effect to adjust the send levels. Adjust these parameters in the MIXER page.

MIDI Send1 responds to CC#93, and Send2 responds to CC#91. At this time, the actual send level uses the value of the Send 1 and 2 settings for Oscillators 1 and 2 of the Programs (selected for the timbres and tracks), multiplied by the Send 1 and 2 values received via MIDI.

The following diagram shows an example of Combination mode. The Timbre 1 output is sent to IFX1 and the Timbre 2 output is sent to IFX2 according to the "Bus" setting. Other timbres are sent to L/R. The output signal goes to OUTPUT L/MONO and R. In the following illustration, the IFX1 "Chain" is On and "Chain to" is set to IFX2, so that the output of IFX1 is sent to IFX2.

Timbre 1 is being processed by IFX1: S01: Stereo Compressor and IFX2: S29: Stereo Phaser effects. Timbre 2 is being processed by the IFX2: S29: Stereo Phaser effect. The Routing Map area of the next diagram shows these settings. (With these settings, IFX3–5 are not being used.)

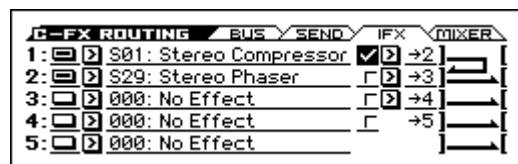
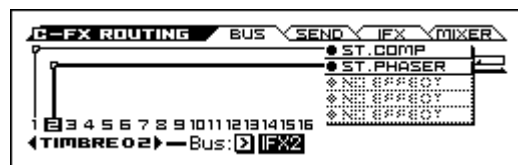

Drum Programs in Combination and Sequencer modes

If you've selected a drum program ("OSC"= Drums) for a timbre (in Combination mode) or track (in Sequencer mode), the DKit setting will be available as a choice for "Bus" (see the following diagram).

With the DKit setting, settings such as the "Bus" setting of each key of the drum kit will be valid, and each drum instrument will be output to the bus destination. For example, snare sounds could be sent to IFX1, kick sounds to IFX2, and other sounds to L/MONO and R.

With settings other than DKit, the output of all drum instruments will follow the "Bus" setting of each timbre/track. This lets you apply an insert effect to all drum instruments, regardless of the settings of the drum kit.

Drum Kit IFX Patch

If the currently-selected **Bus** setting is Dkit, you can use the "DKit IFX Patch" function.

This option allows you to change the routing of the Insert Effects temporarily by changing **Bus** for each key.

For example if you've made assignments for sending each key of the drum kit to IFX1–IFX4, for example so that snare sounds are sent to IFX1 and kick sounds to IFX2, but other timbres or track

programs are using IFX1, this function lets you reassign the bus send for each key of the drum kit, changing them from IFX1–IFX4 to IFX2–IFX5. (In the example described here, snare sounds would then sent to IFX2 and kick sounds to IFX3.)

Patching is possible only if the **Bus** setting of each key of the drum kit is assigned to an insert effect. The state of these settings can also be viewed in the Routing map. Choose “DKit IFX Patch,” and then press the OK button to confirm.

If you want to revert to the original settings of the drum kit, use the Drum Kit IFX Patch with the settings IFX1 → IFX1, IFX2 → IFX2, IFX3 → IFX3, IFX4 → IFX4, and IFX5 → IFX5.

In the following diagram, Drum Program is assigned to Timbre 1, and normal Programs are assigned to Timbres 2 and 3. “Bus” is set to DKit for Timbre 1, IFX1 for Timbre 2, and IFX2 for Timbre 3. With Timbre 1, the “Bus” for DrumKit setting becomes effective.

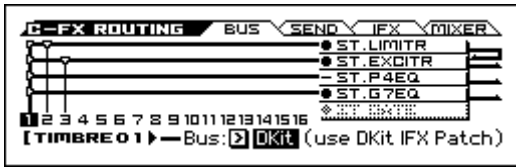

Use the “DKit IFX Patch” parameter if you want the drum program to use effects other than timbres 2 and 3. Temporarily send the drum kit IFX1 to IFX3, IFX2 to IFX4, IFX3 to IFX5 and IFX4 to L/R.

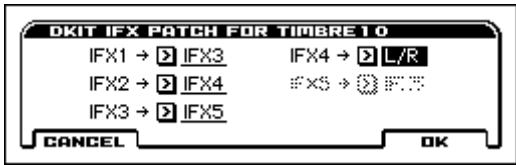

Executing with these settings will temporarily change the effects where the drum kit is being sent.

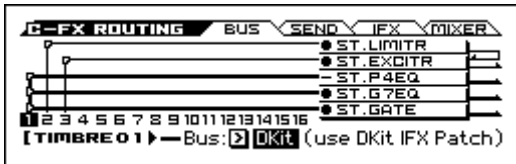

Mixer

In Program, Combination, and Sequencer modes, the insert effect pages (IFX1–IFX5) allow you to specify the “Pan (CC#8),” bus select “Bus,” FX Control bus “FX Ctrl,” and master effect send levels “Send 1” and “Send 2” for the signal that has passed through the insert effect.

If you have turned on the “Chain” to connect the Insert Effects in series, these parameters Pan(CC#8)– Send2 for the post-IFX (last Insert Effect in the chain) signal become effective.

Insert Effect = Stereo In – Stereo Out

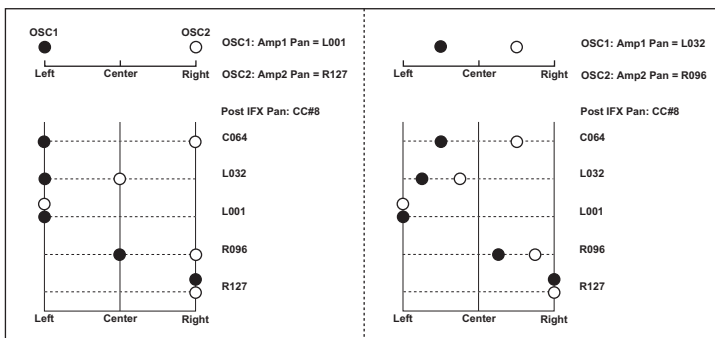

Insert Effect = Mono In - Stereo Out
Mono In - Mono Out

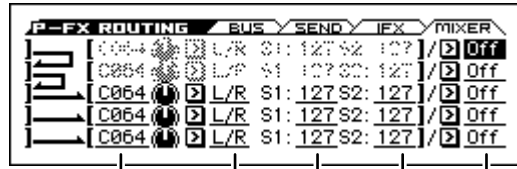
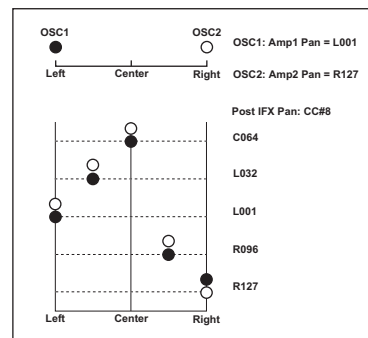

Pan(CC#8) Bus Send1 Send2 FX Control Bus

Pan (CC#8)

This pan setting functions in stereo. You can adjust the stereo position of the output signal while preserving the stereo position specified by the Pan parameters of the program, timbre, or track, and by the stereo position and spread produced by IFX. (See the illustration below)

Note: If the IFX input or output is monaural, the sound may be positioned in the middle regardless of the settings of the program, timbre, or track. (see “In/Out” on page 200)

MIDI You can control these parameters via CC#8.

Bus (Bus Select)

This parameter enables you to specify the destination bus for the post-IFX signals.

L/R is a common setting to send signals to the Master Effect (MFX) before they are routed to the OUTPUT L/MONO and R outputs.

If set to Off, the signal will not be sent to the L/R bus. Choose this setting if you want to use the “Send1” or “Send2” levels to route the signal through a master effect in series (i.e., not as a send effect).

FX Ctrl (FX Control Bus)

This specifies the FX Control bus that follows the insert effect. The FX Control buses (FX Control 1, 2) are mono two-channel buses.

The KROSS provides two (mono two-channel) effect control buses, giving you a wide range of ways to control effects.

FX Control buses can be used with vocoder, limiter, and gate-type effects.

For details on the effects that be used with FX Control buses, see “FX Control Bus” on page 199

Send1, Send2

These specify the send levels where the signals from the insert effects are sent directly to master effects 1 and 2. Signals are sent in stereo to master effects 1 and 2. If you’ve used the chain function to connect an insert effect to another IFX, you can’t send its signal to a master effect.

Here’s how to apply a master effect to sound that’s not using an insert effect:

- In Program mode, the P-FX ROUTING SEND page “OSC1 Send 1,” “OSC1 Send 2,” “OSC2 Send 1” and “OSC2 Send 2” settings will specify the send levels to the master effects.

- In Combination or Sequencer modes, the “Send 1” and “Send 2” settings of each timbre/track will specify the send levels to the master effects.

MIDI Send1 responds to CC#93 and Send2 responds to CC#91.

Controlling the Insert Effects via MIDI

Using the Dynamic Modulation (Dmod) function enables you to control all effect parameters in real-time during performance from the controllers of the KROSS or a connected MIDI sequencer. You can also control the “Pan(CC#8),” “Send1,” and “Send2” parameters in the same way.

Program mode

You can control the parameters on the global MIDI channel (see page 159).

Combination mode

The IFX1–IFX5 pages lets you specify the control channel “Ch” (Control Channel) for IFX1–IFX5. You can choose from CH01–16, Gch, or All-R (All Routed).

Ch01–16: Select this when you want to control each insert effect from a different channel.

Gch: Select this option if you wish to control the parameters on the global MIDI channel. This is a common setting.

All-R: You can control the effect via any channel specified for a timbre that’s routed to that insert effect.

 If you’ve selected a drum program for a Combination mode timbre or a Sequencer mode track, and set its “Bus” to DKit, the MIDI channel of that timbre/track will be valid if any one of IFX1–5 is set to All-R, regardless of the drum kit’s “Bus” (see page 173) setting or the “DKit IFX Patch” setting.

Sequencer mode

Use “Ch” parameters (see page 134) of the IFX1 – IFX5 pages to set up the control channels for IFX1–IFX5. Select an appropriate option from Ch01–16 and All Routed.

Ch01–16: Select this when you want to control each insert effect from a different channel.

All R: Select this option to control the parameters on all the channels that are routed to the corresponding Insert Effects. All R is a typical option. If you wish to control the parameters on a single channel, you may select it from Ch01–16.

Note: Since exclusive messages can be recorded in Sequencer mode, you can use them to automatically switch effects or modify effect parameter values during the song playback.

Master Effects (MFX1, 2)

In/Out



The I/Os of Master Effects MFX1 and MFX2 are stereo-in/stereo-out. “Send1” and “Send2” determine the send level to the Master Effects. (For Send1 and 2, see “Routing” and “Mixer.”)

Master effects will not output the Dry (unprocessed) signal specified in Wet/Dry. Only the Wet (processed) signal will be output. The output signals from the Master Effects are routed to the L/R bus with the output level specified by Return1 and Return2.

Selecting “000: No Effect” will mute the output. The processed signal will be output in one of the following ways, according to the type of effects 001–134.

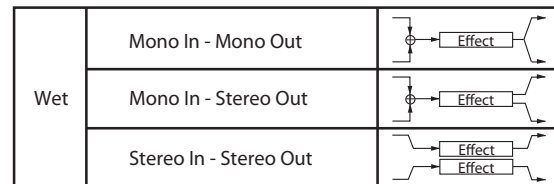

Input/output variations for each effect are shown in upper left of the block diagrams starting on page 207.

In each mode, the MFX-MFX1 and MFX2 “On/Off” parameters turn the master effects on/off. When off, the output is muted in the same way as 000: No Effect.

Tips: You can easily disable the master effects by turning off the front panel MASTER FX button. MFX1/2 will be temporarily disabled; the master effects will remain off even if you switch programs or modes. When you turn the button on, the master effects will be enabled, and the effects specified by the program or combination will be obtained.

Note: The MASTER FX button is linked with the GLOBAL> SYSTEM page Effect SW “MFX” setting (see page 157).

MIDI You can turn MFX1 and MFX2 off by receiving MIDI control change CC#94. A value of 0 turns the effect off; a value of 1–127 returns it to the previous setting. Use the global MIDI channel “Channel” (see page 159) to control this.

Double-size effects

Double-size effects (D00: St.Mltband Limiter– D13: Early Reflections) use twice as much space as other effects.

You can use a double-size effect for master effect MFX1. If you’ve selected a double-size effect, MFX2 won’t be available for use.

Routing

The two master effects MFX1 and MFX2 are available in any mode.

The Send1 and Send2 parameters specify the input routing to master effects MFX1 and MFX2 respectively.

For example, since you can adjust the master effect send levels for each timbre/track, you can adjust the settings so that reverb is applied deeply to the piano, lightly to the strings, and not at all to the bass.

If you're using insert effects, use the post-IFX "Send1" and "Send2" to adjust the send amounts.

Program mode

Use the "OSC1 Send1," "OSC1 Send2," "OSC2 Send1," and "OSC2 Send2" parameters or the "Send1" and "Send2" parameters for the post-IFX1-5 signals, to set the Master Effect send level.

If you have set "Bus" to L/R or Off, "OSC1 Send1," "OSC1 Send2," "OSC2 Send1," and "OSC2 Send2" (see page 59) are effective. These parameters can be set for oscillators 1 and 2 individually.

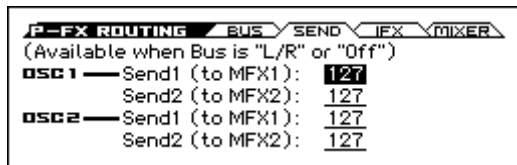

If you have set "Bus" to IFX1-IFX5, "Send1" and "Send2" for the post-IFX1-5 signals are effective. If you are using the Insert Effects in chain (series), the "Send1" and "Send2" parameters for the post-IFX (last IFX) are effective. (see "Mixer" on page 202)

MIDI Send1 responds to CC#93 and Send2 responds to CC#91 on the global MIDI channel (G-MIDI> BASIC). At this time, the actual send level uses the value of the Send 1 and 2 settings for Oscillators 1 and 2, multiplied by the Send 1 and 2 values received via MIDI.

If you have selected "Drums" for "OSC" of a Program, the "DKIT-SET" (see page 59) becomes available.

If you turn on this, "Send1" and "Send2" levels for each key of the selected DrumKit become effective.

If "Bus" (GLOBAL DRUMKIT> VOICE) is set to L/R or Off for a drum instrument key, "Send1 (to MFX1)" and "Send2(toMFX2)" (GLOBAL DRUMKIT> VOICE) become effective. If "Bus" is set to IFX1-5, the post-IFX1-5 "Send1" and "Send2" (P-FX ROUTING> MIXER) become effective.

If this is off, "OSC1 Send1," "OSC1 Send2," "OSC2 Send1," and "OSC2 Send2" (P-FX ROUTING> SEND), and the post IFX1-5 "Send1" and "Send2" (P-FX ROUTING> MIXER) will be valid for all drum instruments, in the same way as when "OSC (Oscillator Mode)" is Single or Double.

Combination and Sequencer modes

Use "Send1" and "Send2" (ROUTING> SEND) for timbres (Combination) and tracks (Sequencer) to set the Send1 and 2 levels for each timbre and track. As with Program mode, if "Bus" is set to L/R or Off, "Send1" and "Send2" become effective.

The actual levels use these Send1 and 2 level values, multiplied by the send level values of oscillators 1 and 2.

Send level

For example if you set the program's "OSC1 Send1" to 127, "OSC1 Send2" to 064, "OSC2 Send1" to 064, "OSC2 Send2" to 127, and the combination's "Send1" to 064 and "Send2" to 127, the actual send levels of the combination will be as follows.

$$\text{OSC1 Send1}=127 (100\%) * 064 (50\%)=064 (50\%)$$

$$\text{OSC2 Send1}=064 (50\%) * 127 (100\%)=064 (50\%)$$

$$\text{OSC2 Send2}=127 (100\%) * 064 (50\%)=032 (25\%)$$

$$\text{OSC2 Send2}=127 (100\%) * 127 (100\%)=127 (100\%)$$

If IFX1-5 is selected for "Bus," use the "Send1" and "Send2" parameters for the post-IFX signals.

MIDI "Send1" responds to CC#93, and "Send2" responds to CC#91. If "Send1" and "Send2" for each timbre/track are effective, the parameter will be controlled on the MIDI channels set for the corresponding timbres and tracks. If the "Send1" and "Send2" parameters for the post-IFX1-5 signals are effective, they can be controlled on the MIDI channels assigned to IFX1-5.

An example for Combination mode is given below. In the following diagram, "Bus" is set so that Timbre 1 is routed to IFX1, Timbre 2 to IFX2, Timbres 3 and 4 to IFX3, Timbres 5-16 to L/R.

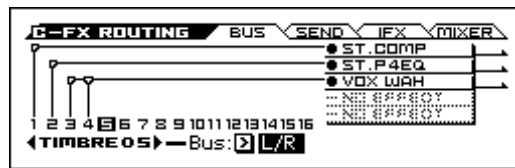

In this case, use "Send1" and "Send2" for the post-IFX1 (S01: Stereo Compressor) signal to set the send level of the Timbre 1 routed to the Master Effect. (In this example they are set to 035 and 000.)

In the same way, use "Send1" and "Send2" for the post-IFX2 signal to set the send levels of Timbres 2, and use the "Send1" and "Send2" parameters for the post-IFX3 signal to set the send levels of Timbres 3 and 4.

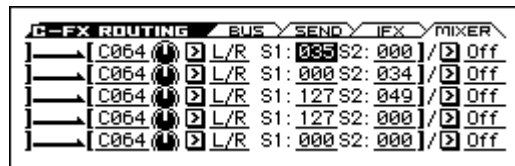

For timbres 5-16, the "Send 1" and "Send 2" settings in the preceding illustration will be valid (in this case, the send levels will be the program's "Send 1" and "Send 2" settings for each oscillator multiplied by these "Send 1" and "Send" settings).

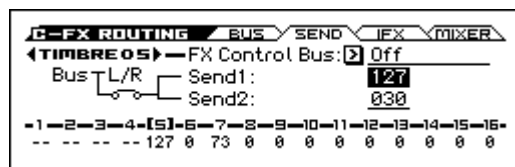

"Bus" DKit is valid if you've selected a drum track for a Timbre (Combination) or Track (Sequencer).

If you select DKit, the "Bus" (see page 173) settings for each key become effective, and each drum instrument sound will be routed to the corresponding buses. At this time, the actual send levels use these Send 1 and 2 values, multiplied by the Send1 and 2 settings for each DrumKit key.

If a drum kit's "Bus" is set to L/R or Off, the levels will be these "Send 1" and "Send 2" settings multiplied by the send levels you specify in "OSC1 Send1" and "OSC1 Send2" (see page 59), just as in other cases ("OSC" Single or Double).

If "Bus" is set to IFX1-5, use "Send1" and "Send2" for the post-IFX signal.

Mixer

You can adjust the input level to the master effects by changing the send level. In each mode, you can adjust output settings for master effects MFX1 and MFX2 by adjusting the output level and specifying the chaining (series connection) between the master effects.



1. Return1, Return2

These adjust the amount of signal that is returned from the master effects MFX1 and MFX2 outputs to the L/R bus.

The left-side value of the Wet/Dry parameter for the MFX1 or 2 effect is the output level of that master effect. (In other words if Wet/Dry is 25:75, the output level is 75%. It is 100% if Wet, and 0% if Dry.)

The Wet/Dry value multiplied by the Return1 or Return2 value is sent to the L/R bus. This sound is then mixed with the oscillator output “Bus” L/R or the “Bus” L/R output that follows the insert effect.

For example, with MFX1 Wet/Dry set to 50:50 (50%) and Return1 set to 64 (50%), the resulting effect level will be 25%. The effect level is maximum (100%) when Wet/Dry is set to “Wet” and Return1 is set to 127.

2. Chain

If this is On, the master effects will be connected in the order of master effect 1 → master effect 2.

In the example shown in the preceding page, the output of MFX1: S64: Stereo Chorus is added to the input of MFX2: 105: Reverb Hall.

3. Chain Level

This specifies the signal level from MFX1 to MFX2 when “Chain” is on.

Controlling the Master Effects via MIDI

In the same way as for insert effects, parameters of the master effects can also be controlled in realtime via Dynamic Modulation (Dmod) from the KROSS’s controllers or an external MIDI device during performance or from the sequencer.

Program mode

Effect parameters are controlled on the global MIDI channel (see page 159).

Combination and Sequencer modes

In Combination and Sequencer modes, the control channel for MFX1 and MFX2 are specified by the Ch (Control Channel) setting in the MFX1 and 2 pages (see page 92, 134). You can choose Ch01–16 or Gch.

Ch01–16: Select this option if you wish to control the parameters for each Master Effect on different channels.

Gch: Select this option if you wish to control the parameters on the global MIDI channel (see page 159). This is the normal setting.

Note: Since Sequencer mode lets you record and play exclusive messages and edit tracks that include System Exclusive events, you can use them to switch effects or modify effect parameter values during song playback.

Effect/Mixer Block Diagram

Effect / Mixer Block Diagram in Program Mode

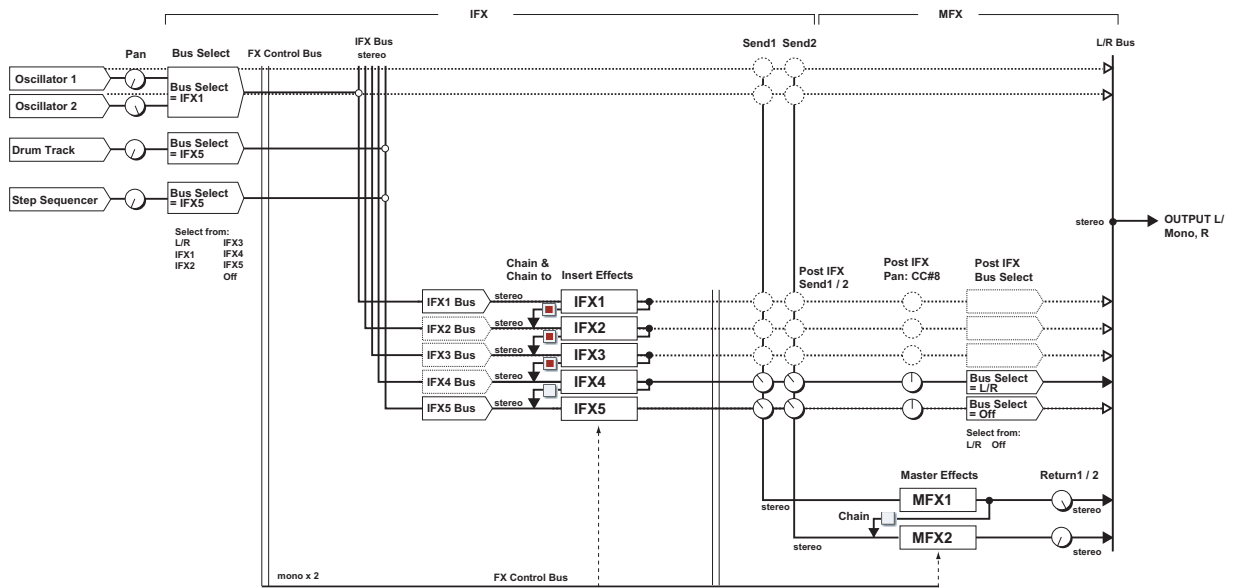

Effect / Mixer Block Diagram in Combination/Sequencer Mode

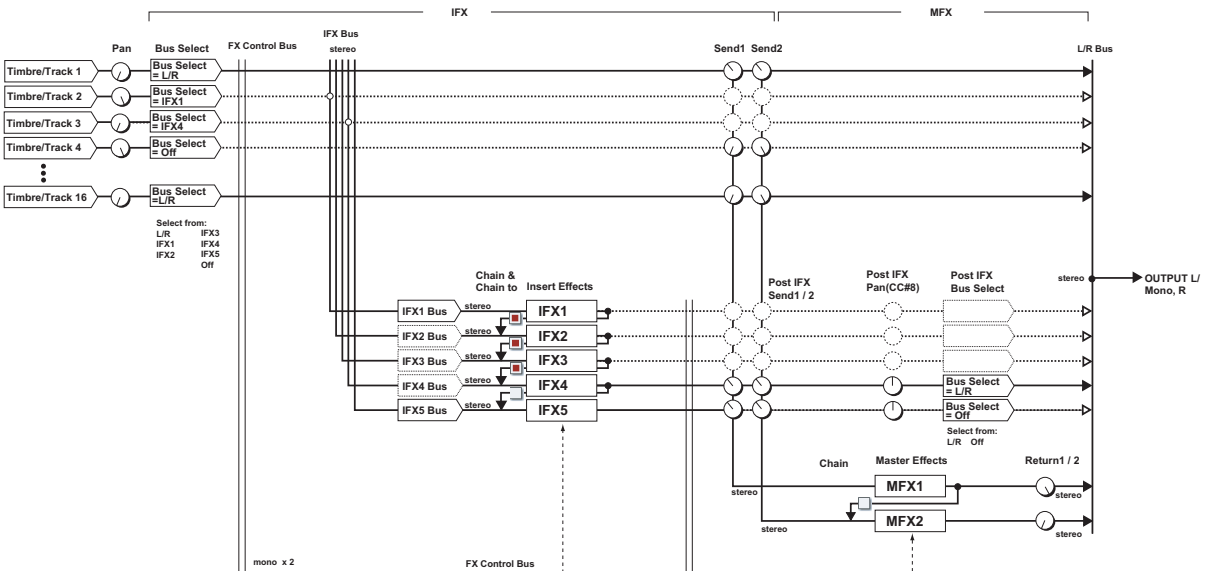

Single size effects

About the names of parameters listed in the effect parameter tables

Two parameter names are listed in these tables. The parameter name shown at left is the name that's shown in the display of the KROSS. The parameter name shown at right is the full name of the parameter. If a "←" is shown, the name shown in the display of the KROSS is the full parameter name. Explanations of the parameter will use the full name.

000: No Effect

Select this option when you do not use any effects. The Insert Effect section outputs unprocessed signals and the Master Effect section mutes the output.

001: Stereo Compressor

This effect compresses the input signal to regulate the level and give a "punchy" effect. It is useful for guitar, piano, and drum sounds. This is a stereo compressor. You can link left and right channels, or use each channel separately.

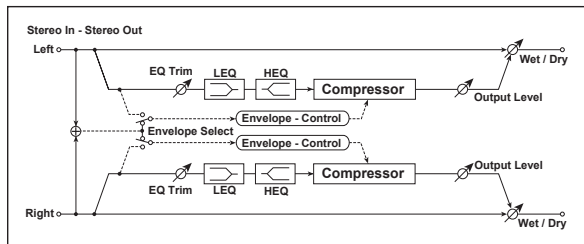

Parameter	Value	Explanation
Env Sel	Envelope Select	L/R Mix, L/R Individually
Sens	Sensitivity	1...100
Attack	←	1...100
PreEQ Trim	←	0...100
Pre LEQ Fc	Low EQ Frequency	Low, Mid-Low
Pre HEQ Fc	High EQ Frequency	High, Mid-High
LEQ [dB]	Low EQ Gain [dB]	-15.0...+15.0
HEQ [dB]	High EQ Gain [dB]	-15.0...+15.0
Out Level	←	0...100
Src	Source	Off...Tempo
Amt	Amount	-100...+100
Wet/Dry	←	Dry, 1 : 99... 99 : 1, Wet
Src	Source	Off...Tempo
Amt	Amount	-100...+100

Envelope

This parameter selects whether the left and right channels are linked to control both signals simultaneously, or whether each channel is controlled independently.

Sensitivity Output Level

The "Sensitivity" parameter sets the sensitivity of the compressor. If this parameter is set to a higher value, lower level sounds will be boosted. With a higher Sensitivity, the overall volume level is higher. To adjust the final volume level, use the "Output Level" parameter.

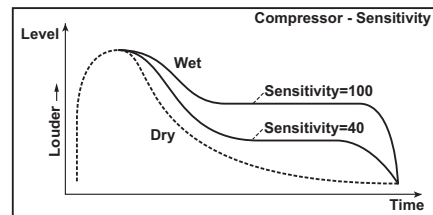

Attack

This parameter controls the attack level.

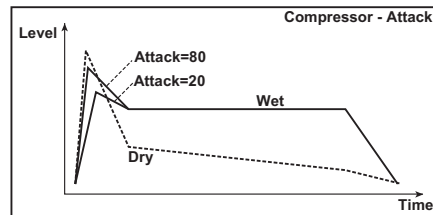

002: Red Comp

When playing chords on an electric piano or similar instrument, it's helpful to use a compressor to keep each note smooth and well-balanced. In addition to a distinctive percussive accent, it will also provide a long sustain. This effect models a popular compressor with a clean sound that's perfect for pop and funk music.

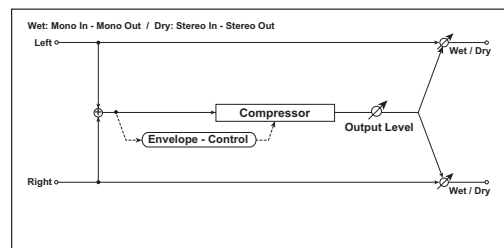

Parameter	Value	Explanation
Sens	Sensitivity	1...100
Attack	←	1...100
Level	←	0...100
Wet/Dry	Wet/Dry	Dry, 1 : 99... 99 : 1, Wet
Src	Source	Off...Tempo
Amt	Amount	-100...+100

003: Stereo Limiter

The Limiter regulates the input signal level. It is similar to the Compressor, except that the Limiter compresses only signals that exceed the specified level to lower unnecessary peak signals. The Limiter applies a peaking-type EQ to the trigger signal (which controls the degree of the Limiter effect), allowing you to set any band width to be covered. This effect is a stereo limiter. You can link left and right channels, or use each channel individually.

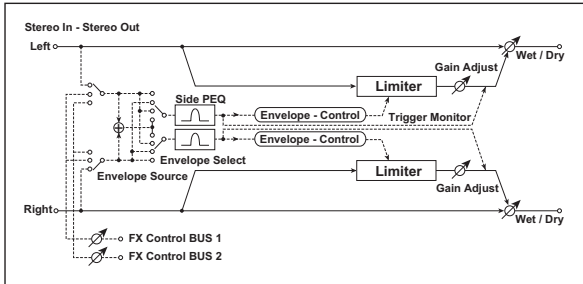

Parameter	Value	Explanation
Env Src	Envelope Source	Selects the trigger source to use: the input signal, FX Control 1, FX Control 2
FXCtrl Trim	FX Control Trim	0...100 Sets the trigger input level from FX Control Bus 1/2
Env Sel	Envelope	L/R Mix, L Only, R Only, L/R Individually Selects from linking both channels, controlling only from left channel, only from the right channel, or controlling each channel individually p.208
Ratio	←	1.0 : 1 ... 50.0 : 1, Inf : 1 Sets the signal compression ratio p.208
Thresh[dB]	Threshold [dB]	-40...0 Sets the level above which the compressor is applied p.208
Attack	←	1...100 Sets the attack time p.208
Release	←	1...100 Sets the release time p.208
Gain [dB]	Gain Adjust [dB]	-Inf, -38...+24 Sets the output gain p.208
Src	Source	Off...Tempo Selects the modulation source for the output gain
Amt	Amount	-63...+63 Sets the modulation amount of the output gain
Side PEQ	Side PEQ Insert	Off, On Toggles between on/off of the trigger signal's EQ p.209
Trigger Monitor	Side PEQ Trigger Monitor	Off, On Switches between effect output monitor and trigger signal monitor p.209
S.PEQ[Hz]	Side PEQ Cutoff [Hz]	20...12.00k Sets the EQ center frequency for the trigger signal p.209
Q	Side PEQ Q	0.5...10.0 Sets the EQ bandwidth for the trigger signal p.209
Gain [dB]	Side PEQ Gain [dB]	-18.0...+18.0 Sets the EQ gain for the trigger signal p.209
Wet/Dry	←	Dry, 1 : 99... 99 : 1, Wet Sets the balance between the effect and the dry input
Src	Source	Off...Tempo Selects a modulation source for Wet/Dry
Amt	Amount	-100...+100 Sets the modulation amount for Wet/Dry

Envelope Source

By selecting FX Control 1 or FX Control 2 you can use the signal of FX Control Bus 1 or 2 as the trigger signal.

For instance, you might use a different, unprocessed sound as the trigger, or apply a limiter triggered by a different timbre (Combination) or track (Sequence). For more information, please see "FX Control Bus" on page 199.

Envelope

When L/R Mix is selected for this parameter, the left and right channels are linked to control the Limiter using the mixed signal. If L Only (or R Only) is selected, the left and right channels are linked, and the Limiter is controlled via only the left (or right) channel.

With L/R individually, the left and right channels control the Limiter individually.

Ratio

Threshold [dB]

Gain Adjust [dB]

This parameter sets the signal compression "Ratio." Compression is applied only when the signal level exceeds the "Threshold" value.

Adjust the output level using the "Gain Adjust" parameter, since compression causes the entire level to be reduced.

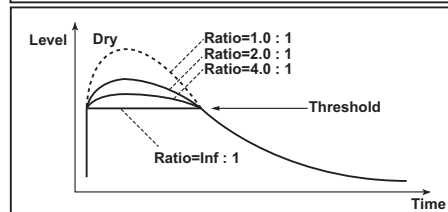
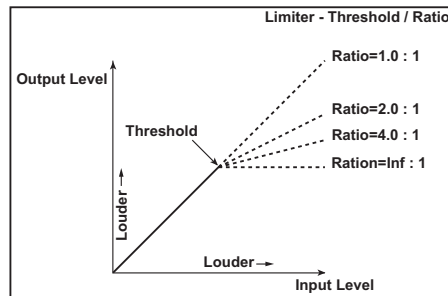

Attack

Release

These parameters set the attack time and release time. A higher attack time will cause the compression to be applied more slowly.

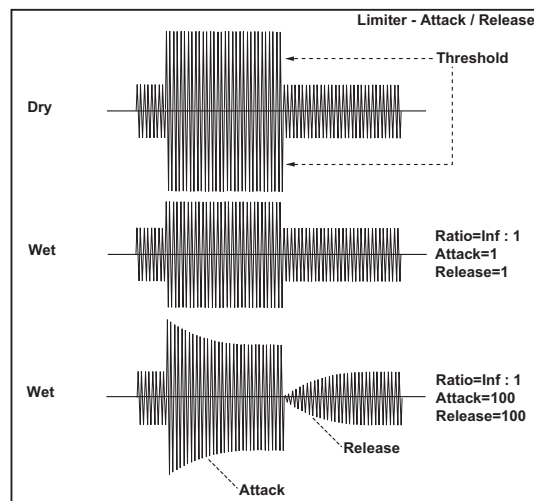

Trigger Monitor

Turning this parameter On will cause the trigger signal to be output, instead of the effect sound. Use this parameter to check the trigger signal with EQ applied. Usually, this should be set to Off.

Side PEQ Insert

Side PEQ Cutoff [Hz]

Q

Gain [dB]

These parameters are used to set the EQ amount that's applied to the trigger signal. The Limiter determines whether the compression is applied or not, based on the post-EQ trigger signal. Setting the equalizer allows you to set the Limiter to respond to any frequency band.

004: Multiband Limiter

This effect applies the Limiter to the low range, mid range, and high range of the input signal. You can control dynamics for each range to adjust the sound pressure of the low range, mid range, and high range in a different way from the EQ.

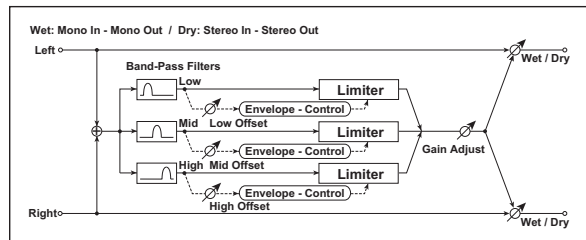

Parameter	Value	Explanation
Ratio	← 1.0 : 1...50.0 : 1, Inf : 1	Sets the signal compression ratio p.208
Thrsh[dB]	Threshold [dB] -40...0	Sets the level above which the compressor is applied p.208
Attack	← 1...100	Sets the attack time p.208
Release	← 1...100	Sets the release time p.208
Lo Ofc[dB]	Low Offset [dB] -40...0	Gain of the low-range trigger signal p.209
M. Ofc[dB]	Mid Offset [dB] -40...0	Gain of the mid-range trigger signal p.209
Hi Ofc[dB]	High Offset [dB] -40...0	Gain of the high-range trigger signal p.209
Gain [dB]	Gain Adjust [dB] -Inf, -38...+24	Sets the output gain p.208
Src	Source Off...Tempo	Selects the modulation source for the output gain
Amt	Amount -63...+63	Sets the modulation amount of the output gain
Wet/Dry	← Dry, 1 : 99... 99 : 1, Wet	Sets the balance between the effect and the dry input
Src	Source Off...Tempo	Selects a modulation source for Wet/Dry
Amt	Amount -100...+100	Sets the modulation amount for Wet/Dry

Low Offset [dB]

Mid Offset [dB]

High Offset [dB]

These parameters set the gain of the trigger signal. For example, if you do not want to apply compression to the high range, reduce the "High Offset" value down below the "Threshold" level. In this way, the high range limiter will not respond, and compression will not be applied.

005: St.MasteringLimiter (Stereo Mastering Limiter)

This is a stereo limiter that is optimized for mastering songs.

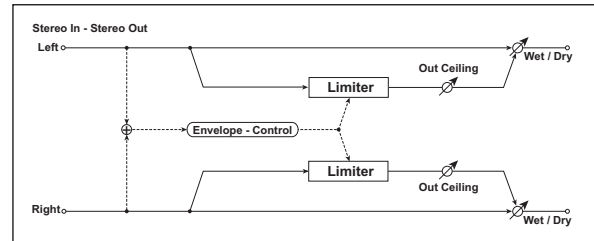

Parameter	Value	Explanation
Thrsh [dB]	Threshold [dB] -30.0...0.0	Sets the level above which the compressor is applied p.208
Ceil[dB]	Out Ceiling [dB] -30.0...0.0	Sets the output gain
Rel [ms]	Release [ms] 0.50...1000.0	Sets the release time p.208
Wet/Dry	← Dry, 1 : 99... 99 : 1, Wet	Sets the balance between the effect and the dry input
Src	Source Off...Tempo	Selects a modulation source for Wet/Dry
Amt	Amount -100...+100	Sets the modulation amount for Wet/Dry

006: Stereo Gate

This effect mutes the input signal when it falls below a specified level. You can also invert the on/off status of the gate, or use note-on/off messages to turn the gate on/off directly.

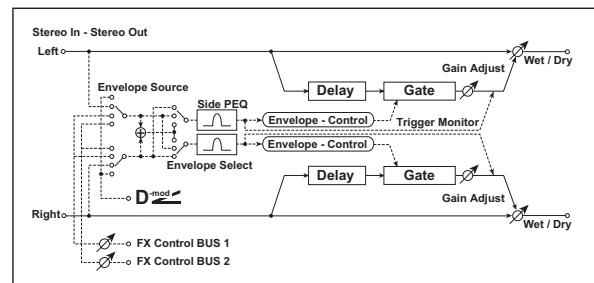

Parameter	Value	Explanation
Env Src	Envelope Source Dmod, Input, FX Control1, FX Control2	Selects the source to control the gate: Dmod control, or use the input signal or FX Control Bus 1 or 2 as a trigger p.208
FXCtrl Trim	Fx Control Trim 0...100	Sets the trigger input level from FX Control Bus 1/2
Env Sel	Envelope L/R Mix, L Only, R Only	Selects the control signal: left and right linked, left only, or right only p.208
Src	Mid Source Off...Tempo	Selects the source that will control the gate when Envelope Src = Dmod
Polarity	← +, -	Switches the polarity of gating p.210
Threshold	← 0...100	Sets the level where gating is applied p.210
Attack	← 1...100	Sets the attack time p.210
Release	← 1...100	Sets the release time p.210

Side PEQ	Side PEQ Insert	Off, On	Switches the trigger signal equalizer on/off p.209
Trigger Monitor	Side PEQ Trigger Monitor	Off, On	Switches between monitoring the effect output and the trigger signal p.209
S.PEQ [Hz]	Side PEQ Cutoff [Hz]	20...12.00k	Sets the center frequency of the equalizer for the trigger signal p.209
Q	Side PEQ Q	0.5...10.0	Sets the bandwidth of the equalizer for the trigger signal p.209
Gain [dB]	Side PEQ Gain [dB]	-18.0...+18.0	Sets the gain of the equalizer for the trigger signal p.209
Wet/Dry	←	Dry, 1 : 99... 99 : 1, Wet	Sets the balance between the effect and the dry input 
Src	Source	Off...Tempo	Selects a modulation source for Wet/Dry
Amt	Amount	-100...+100	Sets the modulation amount for Wet/Dry

Threshold

Attack

Release

“Threshold” specifies the level where gating occurs when “Envelope Select” is set to L/R Mix, L Only, or R Only. “Attack” and “Release” specify the attack time and release time of the gate.

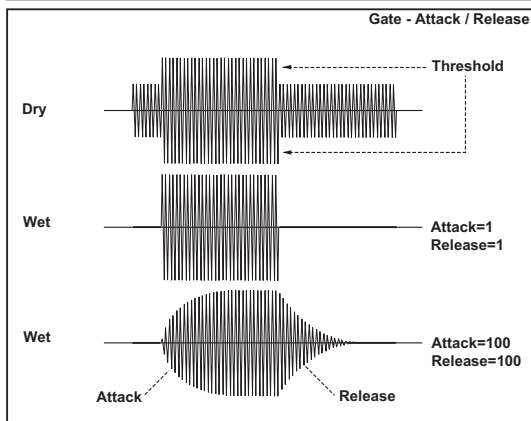
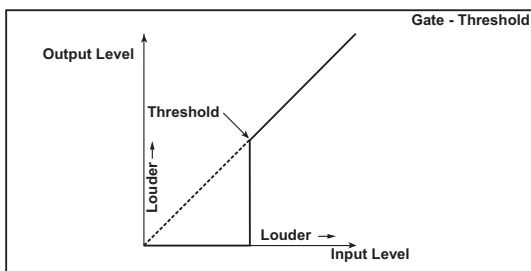

Polarity

This inverts the polarity of the gate on/off functionality. With the “-” setting, the gate will close when the input signal exceeds the specified level. The direction in which the modulation source opens or closes the gate will also be reversed.



Delay Time [ms]

This sets the delay time for the input to the gate. When using shorter Attack Time settings, you can lengthen the Delay Time so that the sound is input after the gate opens.

007: St.Parametric 4EQ (Stereo Parametric 4EQ)

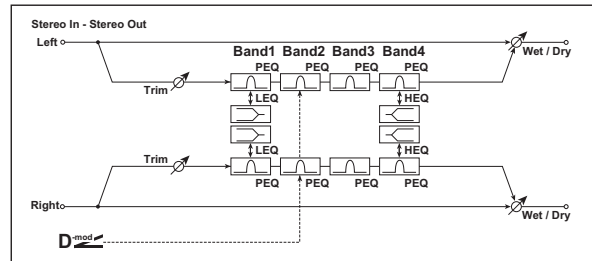
This is a stereo 4-band parametric equalizer. You can select peaking type or shelving type for Band 1 and 4. The gain of Band 2 can be controlled by dynamic modulation.



Parameter	Value	Explanation	
B1 Fc [Hz]	Band1 Cutoff [Hz]	20...1.00k	Sets the center frequency of Band 1
Q	Band1 Q	0.5...10.0	Sets the bandwidth of Band 1 p.211
Gain[dB]	Band1 Gain [dB]	-18.0...+18.0	Sets the gain of Band 1 
B2 Fc[Hz]	Band2 Cutoff [Hz]	50...10.00k	Sets the center frequency of Band 2
Q	Band2 Q	0.5...10.0	Sets the bandwidth of Band 2 p.211
Gain[dB]	Band2 Gain [dB]	-18.0...+18.0	Sets the gain of Band 2 
B3 Fc[Hz]	Band3 Cutoff [Hz]	300...10.00k	Sets the center frequency of Band 3
Q	Band3 Q	0.5...10.0	Sets the bandwidth of Band 3 p.211
Gain[dB]	Band3 Gain [dB]	-18.0...+18.0	Sets the gain of Band 3
B4 Fc[Hz]	Band4 Cutoff [Hz]	500...20.00k	Sets the center frequency of Band 4
Q	Band4 Q	0.5...10.0	Sets the bandwidth of Band 4 p.211
Gain[dB]	Band4 Gain [dB]	-18.0...+18.0	Sets the gain of Band 4
Trim		0...100	Sets the input level
B1Type	Band1 Type	Peaking, Shelf-L (Shelving-Low)	Selects the type of Band 1 p.210
B4Type	Band4 Type	Peaking, Shelf-H (Shelving-High)	Selects the type of Band 4 p.210
B2 Gain Src	Band2 Dynamic Gain Source	Off...Tempo	Selects the modulation source of the Band 2 gain p.211
Amt [dB]	Amount [dB]	-18.0...+18.0	Sets the modulation amount of Band 2 gain p.211
Wet/Dry	←	Dry, 1 : 99... 99 : 1, Wet	Sets the balance between the effect and the dry input 
Src	Source	Off...Tempo	Selects a modulation source for Wet/Dry
Amt	Amount	-100...+100	Sets the modulation amount for Wet/Dry

Band1 Type

Band4 Type

Selects a filter type for Band 1 and 4.

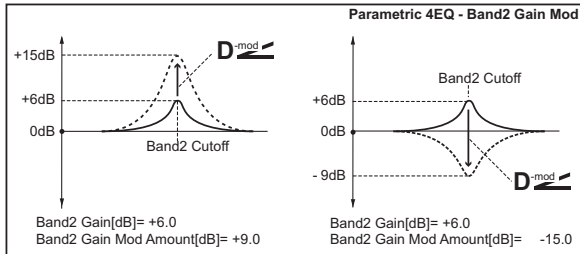
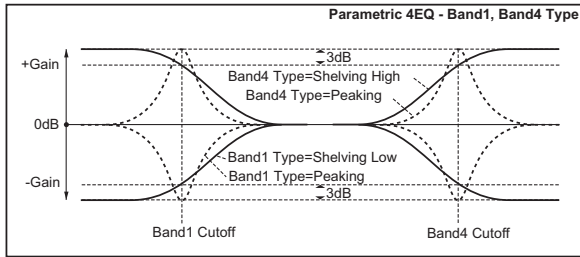

Q These parameters set the bandwidth of each equalizer. The higher the value, the narrower the band becomes.

Band2 Dynamic Gain Source Amount [dB]

You can control the gain of Band 2 using the modulation source.

008: St.Graphic 7EQ (Stereo Graphic 7 Band EQ)

This is a stereo 7-band graphic equalizer. The bar graph of the gain setting for each band gives you a clear, visual idea of frequency responses. You can select a center frequency setting for each band from twelve types, according to the sound.

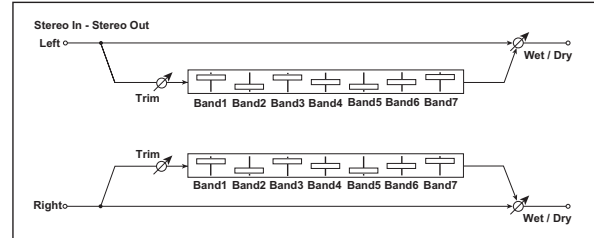

Parameter		Value	Explanation	
Type	←	1:Wide 1, 2:Wide 2, 3:Wide 3, 4:Half Wide 1, 5:Half Wide 2, 6:Half Wide 3, 7:Low, 8:Wide Low, 9:Mid, 10:Wide Mid, 11:High, 12:Wide High	Selects a combination of center frequencies for each band p.211	
Trim	←	0...100	Sets the input level	
Band1 [dB]	←	-18.0...+18.0	Sets the gain of Band 1	
Band2 [dB]	←	-18.0...+18.0	Sets the gain of Band 2	
Band3 [dB]	←	-18.0...+18.0	Sets the gain of Band 3	
Band4 [dB]	←	-18.0...+18.0	Sets the gain of Band 4	
Band5 [dB]	←	-18.0...+18.0	Sets the gain of Band 5	
Band6 [dB]	←	-18.0...+18.0	Sets the gain of Band 6	
Band7 [dB]	←	-18.0...+18.0	Sets the gain of Band 7	
Wet/Dry	←	Dry, 1 : 99... 99 : 1, Wet	Sets the balance between the effect and the dry input	D-mod
Src	Source	Off...Tempo	Selects a modulation source for Wet/Dry	
Amt	Amount	-100...+100	Sets the modulation amount for Wet/Dry	

Type

This parameter selects a combination of center frequencies for each band. The center frequency of each band is shown to the right of its gain indication.

You can configure a 21-Band Graphic EQ ranging from 80 Hz to 18 kHz if you route three Graphic 7-Band EQ effects in series, with a setting of 7:Low, 9:Mid, and 11:High for each EQ.

009: Stereo Exciter

This effect is a combination of the Exciter.

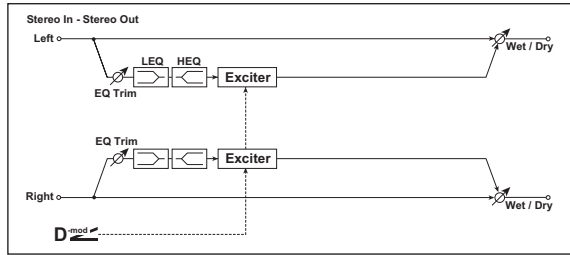

Parameter	Value	Explanation
Blend	Exciter Blend	-100...+100 Sets the intensity (depth) of the Exciter effect
Src	Source	Off...Tempo Selects the modulation source of the Exciter intensity
Amt	Amount	-100...+100 Sets the modulation amount of the Exciter intensity
Frequency	Emphasis Freq	0...70 Sets the frequency to be emphasized
Src	Source	Off...Tempo Selects the modulation source of the frequency to be emphasized
Amt	Amount	-70...+70 Sets the amount of modulation of the frequency to be emphasized
PreEQ Trim	EQ Trim	0...100 Sets the 2-band EQ input level
Pre LEQ Fc	Low EQ Frequency	Low, Mid-Low Selects the cutoff frequency (low or mid-low) of the low-range equalizer
Pre HEQ Fc	High EQ Frequency	High, Mid-High Selects the cutoff frequency (high or mid-high) of the high-range equalizer
LEQ [dB]	Low EQ Gain [dB]	-15.0...+15.0 Sets the gain of the Low EQ
HEQ [dB]	High EQ Gain [dB]	-15.0...+15.0 Sets the gain of the High EQ
Wet/Dry	←	Dry, 1 : 99... 99 : 1, Wet Sets the balance between the effect and the dry input
Src	Source	Off...Tempo Selects a modulation source for Wet/Dry
Amt	Amount	-100...+100 Sets the modulation amount for Wet/Dry

Exciter Blend

This parameter sets the depth (intensity) of the Exciter effect. Positive values give a frequency pattern (to be emphasized) different from negative values.

Emphasis Freq

This parameter sets the frequency to be emphasized. Higher values will emphasize lower frequencies.

010: Stereo Isolator

This is a stereo effect that separates the input signal into low, mid, and high-frequency bands, and controls the volume of each band independently. For example you can separately boost or cut the kick, snare, and hi-hat sounds from a drum signal in realtime.

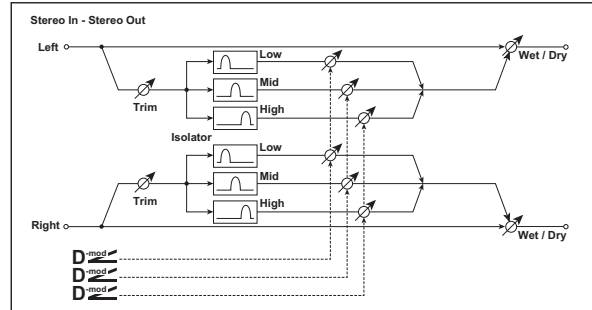

Parameter	Value	Explanation
Low G[dB]	Low Gain [dB]	-Inf, -59...+12 Sets the low-frequency gain
Src	Low Source	Off...Tempo Selects the source that will modulate low-frequency gain
Amt	Low Amount	-72...+72 Sets the amount by which the low-frequency gain will be modulated
Mid G[dB]	Mid Gain [dB]	-Inf, -59...+12 Sets the mid-frequency gain
Src	Mid Source	Off...Tempo Selects the modulation source for mid-frequency gain
Amt	Mid Amount	-72...+72 Sets the amount by which the mid-frequency gain will be modulated
High G[dB]	High Gain [dB]	-Inf, -59...+12 Sets the high-frequency gain
Src	High Source	Off...Tempo Selects the modulation source for high-frequency gain
Amt	High Amount	-72...+72 Sets the amount by which the high-frequency gain will be modulated
Trim	←	0...100 Sets the input level
L/Mid[Hz]	Low/Mid [Hz]	100...500 Sets the frequency where the low and mid bands are divided
Mid/H[Hz]	Mid/High [Hz]	2000...6000 Sets the frequency where the mid and high bands are divided
Wet/Dry	←	Dry, 1 : 99... 99 : 1, Wet Sets the balance between the effect and the dry input
Src	Source	Off...Tempo Selects a modulation source for Wet/Dry
Amt	Amount	-100...+100 Sets the modulation amount for Wet/Dry

011: St. Wah/Auto Wah (Stereo Wah/Auto Wah)

This stereo wah effect allows you to create sounds that range from vintage wah pedal simulations to auto-wah simulations, as well as a wide variety of other settings.

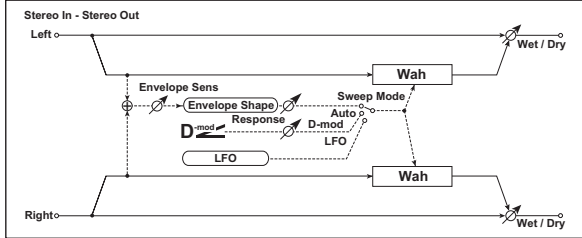

Parameter	Value	Explanation	
Freq Btm	Frequency Bottom	0...100	Sets the lower limit of the wah center frequency p.213
Freq Top	Frequency Top	0...100	Sets the upper limit of the wah center frequency p.213
Resonance	←	0...100	Sets the resonance amount
LPF	←	Off, On	Switches the wah low pass filter on and off
Sweep	Sweep Mode	Auto, Dmod, LFO	Selects the control from auto-wah, modulation source, and LFO p.213
Src	Source	Off...Tempo	Selects the modulation source for the wah when Sweep Mode=Dmod
Resp	Response	0...100	Sets the response speed when Sweep Mode = Auto or Dmod
Env Sens	Envelope Sens	0...100	Sets the sensitivity of auto-wah p.213
Env Shape	Envelope Shape	-100...+100	Sets the sweep curve of auto-wah p.213
LFO [Hz]	LFO Freq [Hz]	0.02...20.00	Sets the speed of the LFO p.213
Src	Source	Off...Tempo	Selects a modulation source for LFO speed
Amt	Amount	-20.00...+20.00	Sets the modulation amount of LFO speed
MIDI Sync	BPM/MIDI Sync	Off, On	When this is on, the LFO speed is set by BPM, Base Note, and Times, instead of Frequency p.213
BPM	←	MIDI, 40.00...300.00	MIDI syncs to the system tempo; 40-300 sets the tempo manually for this individual effect p.213
Base Note	←	♩... ₃	Selects the type of notes that specify the LFO speed p.213
Times	←	x1...x32	Sets the number of notes that specify the LFO speed p.213
Out Level	←	0...100	Sets the output level of the effect sound
Src	Source	Off...Tempo	Selects the modulation source that will control the effect output level
Amt	Amount	-100...+100	Sets the modulation amount of the effect output level
Wet/Dry	←	Dry, 1 : 99... 99 : 1, Wet	Sets the balance between the effect and the dry input
Src	Source	Off...Tempo	Selects a modulation source for Wet/Dry
Amt	Amount	-100...+100	Sets the modulation amount for Wet/Dry

Frequency Bottom Frequency Top

The sweep width and direction of the wah filter are determined by the “Frequency Top” and “Frequency Bottom” settings.

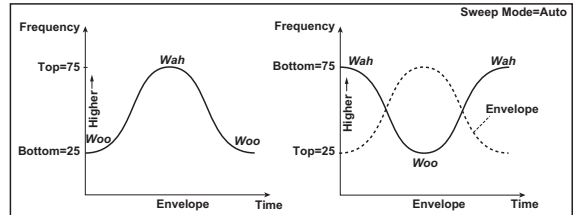
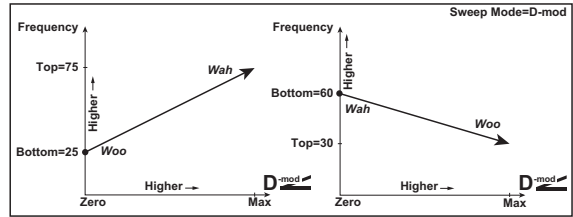

Sweep Mode

This parameter changes the wah control mode. Setting “Sweep Mode” to Auto will select an auto-wah that sweeps according to envelope changes in the input signal level. Auto-wah is frequently used for funk guitar parts and clav sounds.

When “Sweep Mode” is set to Dmod, you can control the filter directly via the modulation source in the same way as a wah pedal. When “Sweep Mode” is set to LFO, the effect uses LFO to sweep in cycle.

Envelope Sens

This parameter sets the sensitivity of the auto-wah. Increase the value if the input signal is too low to sweep. Reduce the value if the input signal is so high that the filter is stopped temporarily.

Envelope Shape

This parameter determines the sweep curve for the auto-wah.

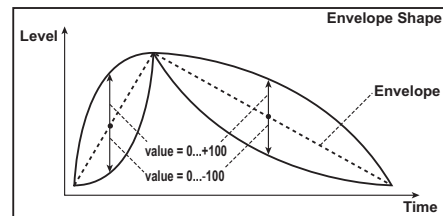

LFO Freq [Hz]

BPM/MIDI Sync

When “BPM/MIDI Sync”=Off, the LFO speed uses the “LFO Freq [Hz]” parameter setting. When “BPM/MIDI Sync”=On, the LFO speed follows the “BPM,” “Base Note,” and “Times” settings.

BPM

Base Note

Times

One cycle of LFO sweep is obtained by multiplying the length of a note (♩...₃) (selected for “Base Note,” in relation to the tempo specified in “BPM,” or the MIDI Clock tempo if “BPM” is set to MIDI) by the number specified in the Times parameter.

012: St.Vintage Wah (Stereo Vintage Wah)

This effect simulates the tonal character of a vintage wah pedal. You can customize the tone and range settings.

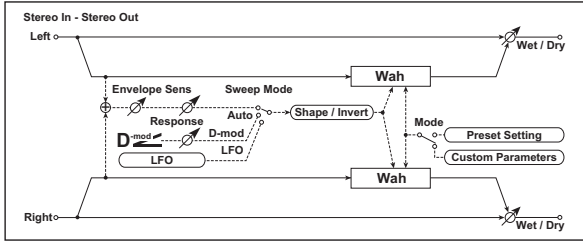

Parameter	Value	Explanation	
Mode	←	Preset, Custom Selects either preset or custom settings p.214	
Shape	←	-100...+100 Sets the curve of the sweep p.214	
Inv	Invert	Off, On Inverts the polarity of the sweep	
Cstm F Btm	Frequency Bottom	0...100 Sets the lower limit of the wah center frequency when Mode = Custom p.214	
Cstm F Top	Frequency Top	0...100 Sets the upper limit of the wah center frequency when Mode = Custom p.214	
Cstm R Btm	Resonance Bottom	0...100 Sets the lower limit of resonance amount when Mode=Custom p.214	
Cstm R Top	Resonance Top	0...100 Sets the upper limit of resonance amount when Mode=Custom p.214	
Sweep	Sweep Mode	Auto, Dmod, LFO Selects the control from auto-wah, modulation source, and LFO p.213	
Src	Source	Off...Tempo Selects the modulation source for the wah when Sweep Mode=Dmod	D ^{mod}
Manu	Manual	0...100 Sets the center frequency when Sweep Mode=Dmod and Source=Off	
Env Sens	Envelope Sens	0...100 Sets the auto-wah sensitivity	
Response	←	0...100 Sets the speed of response when Sweep Mode=Auto or Dmod	
LFO [Hz]	LFO Freq [Hz]	0.02...20.00 Sets the speed of the LFO p.213	D ^{mod}
Src	Source	Off...Tempo Selects a modulation source for LFO speed	
Amt	Amount	-20.00...+20.00 Sets the modulation amount of LFO speed	
MIDI Sync	BPM/MIDI Sync	Off, On When this is on, the LFO speed is set by BPM, Base Note, and Times, instead of Frequency p.213	MIDI Sync
BPM	←	MIDI, 40.00...300.00 MIDI syncs to the system tempo; 40-300 sets the tempo manually for this individual effect p.213	
Base Note	←	 Selects the type of notes that specify the LFO speed p.213	
Times	←	x1...x32 Sets the number of notes that specify the LFO speed p.213	
Out Level	←	0...100 Sets the output level of the effect sound	D ^{mod}

Src	Source	Off...Tempo	Selects the modulation source that will control the effect output level	
Amt	Amount	-100...+100	Sets the modulation amount of the effect output level	
Wet/Dry	←	Dry, 1 : 99... 99 : 1, Wet	Sets the balance between the effect and the dry input	D ^{mod}
Src	Source	Off...Tempo	Selects a modulation source for Wet/Dry	
Amt	Amount	-100...+100	Sets the modulation amount for Wet/Dry	

Shape

This parameter specifies the sweep curve of the wah. It applies to all control via auto-wah, modulation source, and LFO, and lets you adjust subtle nuances of the wah effect.

Mode

Frequency Bottom

Frequency Top

Resonance Bottom

Resonance Top

If Mode=Preset, this simulates a vintage wah pedal. In this case, internally fixed values are used for Frequency Bottom/Top and Resonance Bottom/Top, and these settings will be ignored. The settings for Frequency Bottom/Top and Resonance Bottom/Top are valid if Mode=Custom.

013: VOX Wah

This models the legendary VOX V847 and V848 Clyde McCoy wah pedals. Its distinctive tone, sounding as though it were wrung from the throat, made this pedal a favorite of many pro musicians.

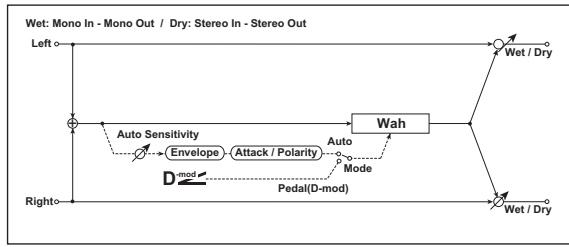

Paramter		Value	Explanation
Type	Type	V847, V848	Selects the type of wah
Open	←	1...100	Sets the lower limit of the wah center frequency p.213
Close	←	1...100	Sets the upper limit of the wah center frequency p.213
Sweep	Sweep Mode	Pedal(Dmod), Auto	Switches between pedal wah and auto-wah
Src	Pedal Source	0...100	Specifies the modulation source that will use the pedal wah
Manu	Pedal Manual	0...100	Sets the center frequency for the pedal wah when the modulation source is not moved
Auto Sens	Auto Sensitivity	0...100	Sets the auto-wah sensitivity
Attack	Auto Attack		Sets the auto-wah's attack speed
Pol	Auto Polarity	Auto, Dmod, LFO	Specifies whether the auto-wah sweep is normal or inverted
Wet/Dry	←		Sets the balance between the effect and the dry input
Src	Source		Selects a modulation source for Wet/Dry
Amt	Amount		Sets the modulation amount for Wet/Dry

014: St. Random Filter (Stereo Random Filter)

This stereo band pass filter uses a step-shape waveform and random LFO for modulation. You can create a special effect from filter oscillation.

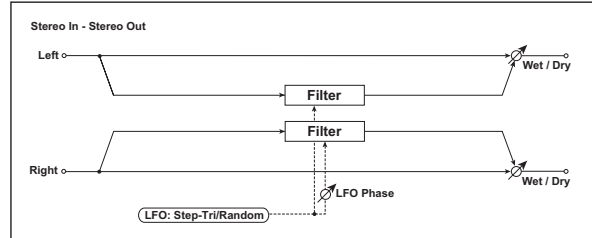

Paramter		Value	Explanation
LFO	LFO Waveform	StpTri, Rndm	Selects the LFO Waveform p.216
LFO Phase	[deg]	← -180...+180	Sets the LFO phase difference between the left and right p.216
LFO	[Hz] LFO Freq [Hz]	0.02...20.00	Sets the speed of the LFO p.216
Src	Source	Off...Tempo	Selects the modulation source used for both LFO speed and step speed
Amt	Amount	-20.00...+20.00	Sets the modulation amount of LFO speed
Step[Hz]	Step Freq [Hz]	0.05...50.00	Sets the LFO step speed (speed that changes in steps p.216
Amt	Amount	-50.00...+50.00	Sets the modulation amount of LFO step speed
BPM/MIDI Sync	←	Off, On	When this is on, the LFO speed is set by BPM, Base Note, and Times, instead of Frequency p.213
BPM	←	MIDI, 40.00...300.00	MIDI syncs to the system tempo; 40-300 sets the tempo manually for this individual effect p.216
Base Note	←		Selects the type of notes that specify the LFO speed p.216
Times	←	x1...x32	Sets the number of notes that specify the LFO speed p.216
Step Base Note	←		Selects the type of notes to specify the LFO step speed p.216
Times	←	x1...x32	Sets the number of notes to specify the LFO step speed p.216
Manual	Manual	0...100	Sets the filter center frequency
Src	Source	Off...Tempo	Selects the modulation source for the filter center frequency
Amt	Amount	-100...+100	Sets the modulation amount for the filter center frequency
Depth	←	0...100	Sets the modulation depth of filter center frequency
Src	Source	Off...Tempo	Selects the modulation source of filter modulation
Amt	Amount	-100...+100	Sets the modulation amount of filter modulation
Resonance	←	0...100	Sets the resonance amount

Wet/Dry	←	-Wet... -99 : 1, Dry, 99 : 1...Wet	Sets the balance between the effect and the dry input p.216	
Src	Source	Off...Tempo	Selects a modulation source for Wet/Dry	
Amt	Amount	-100...+100	Sets the modulation amount for Wet/Dry	

Phase [deg]

Offsetting the left and right phases alters how modulation is applied to the left and right channels, creating a swelling effect.

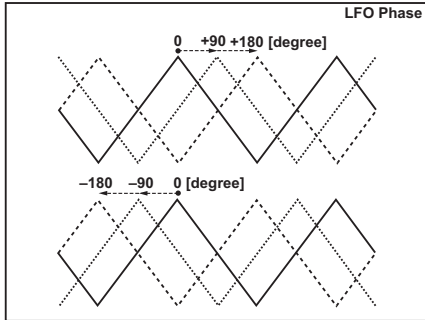

LFO Waveform

LFO Freq [Hz]

Step Freq [Hz]

When “LFO Waveform” is set to StpTri (Step-Tri), LFO is a step-shape, Tri (Triangle) waveform. The “LFO Freq [Hz]” parameter sets the original triangle waveform speed. Changing the “Step Freq [Hz]” parameter enables you to adjust the width of the steps. When “LFO Waveform” is set to Rndm (Random), the “Step Freq [Hz]” parameter uses a random LFO cycle.

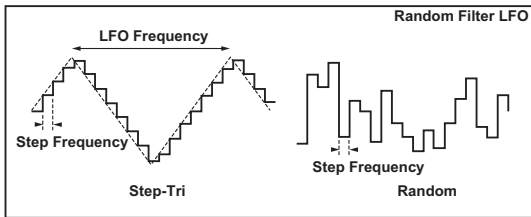

BPM

Step Base Note

Times

The width of an LFO step, or a cycle of random LFO, is obtained by multiplying the length of a note (♪...♪) (selected for “Step Base Note,” in relation to the tempo specified in “BPM,” or the MIDI Clock tempo if “BPM” is set to MIDI) by the number specified in the “Times” parameter.

Wet/Dry

The effect sound’s phase will be reversed when you set this parameter in the range of values from -Wet to -1:99.

015: St.MultiModeFltr (Stereo Multi Mode Filter)

This is a multi-mode filter with four types; low pass, high pass, band pass, and band reject. You can use LFO or dynamic modulation to vary the cutoff frequency or resonance.

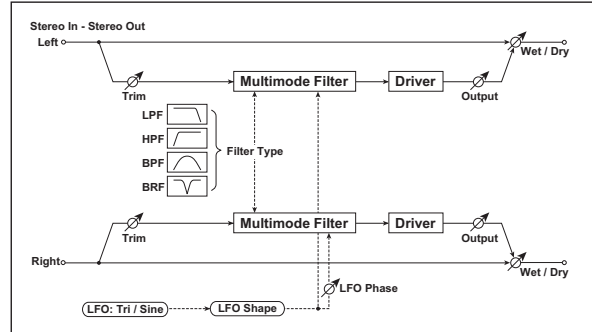

Parameter	Value	Explanation	
Filter Type	← LPF, HPF, BPF, BRF	Selects the type of filter	
Trim	← 0...100	Sets the input level	
Cutoff	← 0...100	Sets the cutoff frequency (center frequency)	
Src	Source	Selects the modulation source of the cutoff	
Amt	Amount	-100...+100	Sets the modulation amount of the cutoff
Resonance	← 0...100	Sets the resonance amount	
Src	Source	Off...Tempo	Selects the source that will modulate the amount of resonance
Amt	Amount	-100...+100	Sets the amount by which the resonance will be modulated
Depth	LFO Depth	0...100	Sets the depth of how the LFO will modulate the cutoff frequency
LFO	LFO Waveform	Tri (Triangle), Sine	Selects the LFO Waveform
LFO Phase [deg]	← -180...+180	Sets the LFO phase difference between the left and right p.216	
LFO [Hz]	LFO Freq [Hz]	0.02...20.00	Sets the speed of the LFO p.216
Src	Source	Off...Tempo	Selects a modulation source for LFO speed
Amt	Amount	-20.00...+20.00	Sets the modulation amount of LFO speed
MIDI Sync	BPM/MIDI Sync	Off, On	When this is on, the LFO speed is set by BPM, Base Note, and Times, instead of Frequency p.213
BPM	←	MIDI, 40.00...300.00	MIDI syncs to the system tempo; 40-300 sets the tempo manually for this individual effect p.213
Base Note	←	♪...♪	Selects the type of notes that specify the LFO speed p.213
Times	←	x1...x32	Sets the number of notes that specify the LFO speed p.213
Drive Sw	←	Off, On	Switches distortion on/off within the filter
DriveLevel	←	0...100	Sets the output level
Drive Gain	←	0...100	Sets the distortion amount
Low Boost	←	0...100	Sets the amount of low-range boost
Wet/Dry	←	Dry, 1 : 99... 99 : 1, Wet	Sets the balance between the effect and the dry input
Src	Source	Off...Tempo	Selects a modulation source for Wet/Dry
Amt	Amount	-100...+100	Sets the modulation amount for Wet/Dry

016: St. Sub Oscillator (Stereo Sub Oscillator)

This effect adds very low frequencies to the input signal. It is very useful when simulating a roaring drum sound or emphasizing powerful low range. This effect is different from the equalizer in that you can add very low range harmonics. You can also adjust the oscillator frequency to match a particular note number, for use as an octaver.

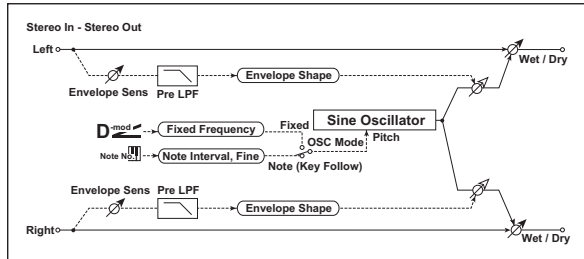

Parameter	Value	Explanation
OSC Mode	←	Note (Key Follow), Fixed Determines whether the oscillator frequency follows the note number or whether it is fixed p.217
NoteInterval	Note Interval	-48...0 Sets the pitch difference from the note number when OSC Mode=Note Follow (Key Follow) p.217
Note Fine	←	-100...+100 Fine adjustment of the oscillator frequency p.217
Fixed[Hz]	Fixed Freq [Hz]	10.0...80.0 Sets the oscillator frequency when OSC Mode=Fixed D^{mod}
Src	Source	Off...Tempo Selects the modulation source for the oscillator frequency when OSC Mode=Fixed
Amt	Amount	-80...+80 Sets the oscillator frequency modulation amount when OSC Mode=Fixed
Env PreLPF	Envelope Pre LPF	1...100 Sets the upper limit of the frequency range where very low harmonics are added p.217
Env Sens	Envelope sens	0...100 Sets the sensitivity with which very low harmonics are added
Env Shape	Envelope Shape	-100...+100 Sets the oscillator's volume envelope curve
Wet/Dry	←	Dry, 1 : 99... 99 : 1, Wet Sets the balance between the effect and the dry input D^{mod}
Src	Source	Off...Tempo Selects a modulation source for Wet/Dry
Amt	Amount	-100...+100 Sets the modulation amount for Wet/Dry

OSC Mode

Note Interval

Note Fine

The "OSC Mode" parameter selects the oscillator operation mode. When Note Follow (Key Follow) is selected, the oscillator's frequency is determined based on the note number, allowing you to use it as an octaver. The "Note Interval" parameter sets the pitch offset from the original note number by semitone steps. The "Note Fine" parameter allows you to fine-tune in steps of cents.

Env. Pre LPF

This parameter sets the upper limit of the frequency range where very low harmonics are added. Adjust this parameter if you do not want to add lower harmonics to the higher range.

017: Talking Modulator

This effect adds an unusual character, like a human voice, to the input signal. Modulating the tone via dynamic modulation, you can create an interesting effect that sounds as if the guitar or synthesizer is talking.

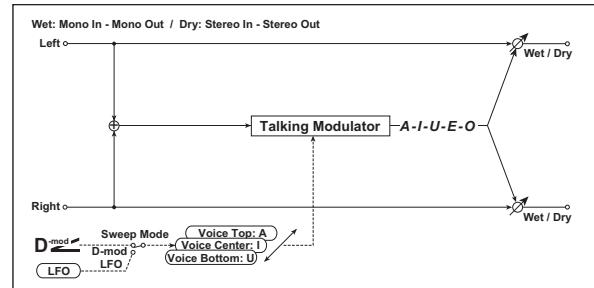

Parameter	Value	Explanation
Sweep	Sweep Mode	Dmod, LFO Switches between modulation source control and LFO control
Src	Source	Off...Tempo Selects the modulation source that controls the voice pattern D^{mod}
Manu	Manual Voice Ctrl	Btm, 1...49, Cnt, 51...99, Top Voice pattern control
Voice Top	←	A, I, U, E, O Selects a vowel sound at the top end of control p.217
Voice Cnt	Voice Center	A, I, U, E, O Selects a vowel sound in the center of control p.217
Voice Btm	Voice Bottom	A, I, U, E, O Selects a vowel sound at the bottom end of control p.217
FormntSft	Formant Shift	-100...+100 Sets the frequency where the effect is applied p.218
Resonance	←	0...100 Sets the Level of resonance of the voice pattern p.218
LFO [Hz]	LFO Freq [Hz]	0.02...20.00 Sets the speed of the LFO D^{mod}
Src	Source	Off...Tempo Selects a modulation source for LFO speed
Amt	Amount	-20.00... +20.00 Sets the modulation amount of LFO speed
MIDI Sync	BPM/MIDI Sync	Off, On When this is on, the LFO speed is set by BPM, Base Note, and Times, instead of Frequency p.213 MIDI Sync
BPM	←	MIDI, 40.00... 300.00 MIDI syncs to the system tempo; 40-300 sets the tempo manually for this individual effect p.213
Base Note	←	 Selects the type of notes that specify the LFO speed p.213
Times	←	x1...x32 Sets the number of notes that specify the LFO speed p.213
Wet/Dry	←	Dry, 1 : 99... 99 : 1, Wet Sets the balance between the effect and the dry input D^{mod}
Src	Source	Off...Tempo Selects a modulation source for Wet/Dry
Amt	Amount	-100...+100 Sets the modulation amount for Wet/Dry

Voice Top

Voice Center

Voice Bottom

These parameters assign vowels to the top, center, and bottom position of the controller.

E.g.: When “Voice Top”=A, “Voice Center”=I, and “Voice Bottom”=U:

If **Sweep Mode** is Dmod, and P.Bend is selected as the modulation source, moving the pitch bend wheel from the farthest position toward yourself will make the voice change through the ranges “a,” “i,” and “u.”

If **Sweep Mode** is set to LFO, the sound will change cyclically from “a” to “i,” “u,” “i,” then “a.”

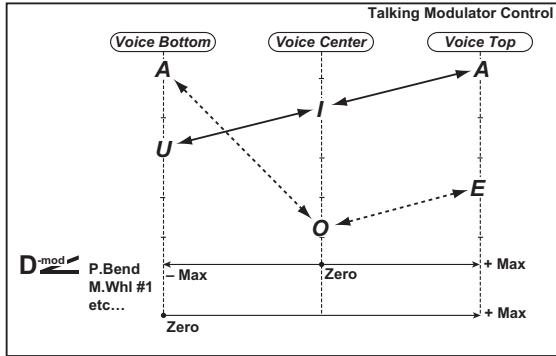

Formant Shift

This parameter adjusts the frequency level where the effect is applied. If you wish to apply the effect to a higher-range sound, set this parameter to a higher value; to apply the effect to a lower-range sound, set this to a lower value.

Resonance

This parameter sets the intensity of resonance for the voice pattern. A larger value will add more character to the sound.

018: St. Decimator (Stereo Decimator)

This effect creates a rough sound like a cheap sampler by lowering the sampling frequency and data bit length. You can also simulate noise unique to a sampler (aliasing).

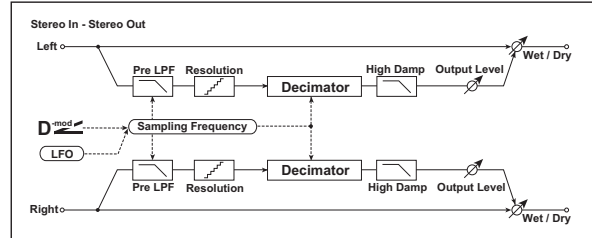

Parameter	Value	Explanation
Pre LPF	Pre LPF	Off, On Selects whether the harmonic noise caused by a decrease in sampling frequency is generated or not p.219
HiDamp[%]	High Damp [%]	0...100 Sets the ratio of cut of the high range
Fs [Hz]	Sampling Freq [Hz]	1.00k... 48.00k Sets the sampling frequency
Src	Source	Off...Tempo Selects the modulation source of the sampling frequency
Amt	Amount	-48.00k... +48.00k Sets the modulation amount of the sampling frequency
LFO Depth	Depth	0...100 Sets the depth of the sampling frequency LFO modulation
Src	Source	Off...Tempo Selects the LFO modulation source of the sampling frequency
Amt	Amount	-100...+100 Sets the LFO modulation amount of the sampling frequency
LFO [Hz]	LFO Freq [Hz]	0.02...20.00 Sets the speed of the LFO
Src	Source	Off...Tempo Selects a modulation source for LFO speed
Amt	Amount	-20.00... +20.00 Sets the modulation amount of LFO speed
MIDI Sync	BPM/MIDI Sync	Off, On When this is on, the LFO speed is set by BPM, Base Note, and Times, instead of Frequency
BPM	←	MIDI, 40.00... 300.00 MIDI syncs to the system tempo; 40-300 sets the tempo manually for this individual effect
Base Note	←	♪... Selects the type of notes that specify the LFO speed
Times	←	x1...x32 Sets the number of notes that specify the LFO speed
Bit Reso	Resolution [bit]	4...24 Sets the data bit length p.219
Out Level	Output Level	0...100 Sets the output level p.219
Src	Source	Off...Tempo Selects the modulation source for the output level
Amt	Amount	-100...+100 Sets the modulation amount of the output level
Wet/Dry	←	Dry, 1 : 99... 99 : 1, Wet Sets the balance between the effect and the dry input
Src	Source	Off...Tempo Selects a modulation source for Wet/Dry
Amt	Amount	-100...+100 Sets the modulation amount for Wet/Dry

Pre LPF

If a sampler with a very low sampling frequency receives very high-pitched sound that could not be heard during playback, it could generate pitch noise that is unrelated to the original sound. Set “Pre LPF” to On to prevent this noise from being generated. If you set the “Sampling Fre” to about 3 kHz and set “Pre LPF” to Off, you can create a sound like a ring modulator.

Resolution [bit]**Output Level**

If you set a smaller value for the “Resolution” parameter, the sound may be distorted. The volume level may also be changed. Use “Output Level” to adjust the level.

019: St. Analog Record (Stereo Analog Record)

This effect simulates the noise caused by scratches and dust on analog records. It also reproduces some of the modulation caused by a warped turntable.

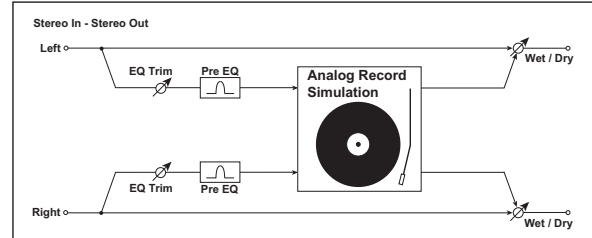

Parameter	Value	Explanation	
Spd/RPM	Speed	33 1/3, 45, 78	Sets the r.p.m. of a record
Flutter	←	0...100	Sets the modulation depth p.219
Noise Dens	Noise Density	0...100	Sets the noise density
Noise Tone	←	0...100	Sets the noise tone
NoiseLevel	Noise Level	0...100	Sets the noise level D-mod
Src	Source	Off...Tempo	Selects the modulation source for the noise level
Amt	Amount	-100...+100	Sets the modulation amount of the noise level
ClickLevel	Click Level	0...100	Sets the click noise level p.219 D-mod
Src	Source	Off...Tempo	Selects the modulation source for the click noise level
Amt	Amount	-100...+100	Sets the modulation amount of the click noise level
EQ Trim	Pre EQ Trim	0...100	Sets the EQ input level
PEQ F[Hz]	Pre EQ Cutoff [Hz]	300...10.00k	Sets the EQ center frequency
Q	←	0.5...10.0	Sets the EQ band width
Gain [dB]	←	-18.0...+18.0	Sets the EQ gain
Wet/Dry	←	Dry, 1 : 99... 99 : 1, Wet	Sets the balance between the effect and the dry input D-mod
Src	Source	Off...Tempo	Selects a modulation source for Wet/Dry
Amt	Amount	-100...+100	Sets the modulation amount for Wet/Dry

Flutter

This parameter enables you to set the depth of the modulation caused by a warped turntable.

Click Level

This parameter enables you to set the level of the click noise that occurs once every rotation of the turntable. This simulation reproduces record noise, and the noise generated after the music on a vinyl record finishes.

020: OD/Hi.Gain Wah (Overdrive/Hi.Gain Wah)

This distortion effect utilizes an Overdrive mode and a Hi-Gain mode. Controlling the wah effect, the 3-band EQ, and the amp simulation will allow you to create versatile distortion sounds. This effect is suitable for guitar and organ sounds.

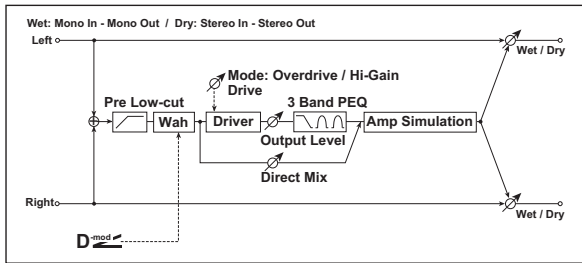

Parameter	Value	Explanation	
Wah	←	Off, On	Switches Wah on/off p.220
Src	Source	Off...Tempo	Selects the modulation source that switches the Wah on and off
Sw	Switch Mode	Toggle, Momnt	Selects the switching mode for the modulation source that switches the Wah on and off p.220
Wah Range	Wah Sweep Range	-10...+10	Sets the range of Wah p.220
WahSweep Src	←	Off...Tempo	Selects the modulation source that controls the Wah p.220
Mode	Drive Mode	Overdrive, Hi-Gain	Switches between overdrive and hi-gain distortion
Drive	←	1...100	Sets the degree of distortion p.220
Pre Low-cut	←	0...10	Sets the low range cut amount of the distortion input p.220
Out Level	Output Level	0...50	Sets the output level p.220
Src	Source	Off...Tempo	Selects the modulation source for the output level
Amt	Amount	-50...+50	Sets the modulation amount of the output level
Low F [Hz]	Low Cutoff [Hz]	20...1.00k	Sets the center frequency for Low EQ (shelving type)
Gain [dB]	Low Gain [dB]	-18...+18	Sets the gain of Low EQ
Mid1 F [Hz]	Mid1 Cutoff [Hz]	300...10.00k	Sets the center frequency for Mid/High EQ 1 (peaking type)
Q	Mid1 Q	0.5...10.0	Sets the band width of Mid/High EQ 1 p.211
Gain [dB]	Mid1 Gain [dB]	-18...+18	Sets the gain of Mid/High EQ 1
Mid2 F [Hz]	Mid2 Cutoff [Hz]	500...20.00k	Sets the center frequency for Mid/High EQ 2 (peaking type)
Q	Mid2 Q	0.5...10.0	Sets the band width of Mid/High EQ 2 p.211
Gain [dB]	Mid2 Gain [dB]	-18...+18	Sets the gain of Mid/High EQ 2
Direct Mix	←	0...50	Sets the amount of the dry sound mixed to the distortion
SpeakerSim	Speaker Simulation	Off, On	Switches the speaker simulation on/off
Wet/Dry	←	Dry, 1 : 99... 99 : 1, Wet	Sets the balance between the effect and the dry input

Src	Source	Off...Tempo	Selects a modulation source for Wet/Dry
Amt	Amount	-100...+100	Sets the modulation amount for Wet/Dry

Wah

The Wah parameter switches the wah effect on/off.

Switch Mode

This parameter sets how the wah effect is switched on and off via the modulation source.

When “Switch Mode” = Moment, the wah effect is usually turned off. It is turned on only when you press the pedal or use the modulation wheel.

When a value for the modulation source is less than 64, “off” speed is selected, and when the value is 64 or higher, “on” is selected.

When “Switch Mode” = Toggle, the wah effect is switched between on and off each time you press the pedal or use the modulation wheel.

The switch will be turned on/off each time the value of the modulation source exceeds 64.

Sweep Range

Source

This parameter sets the sweep range of the wah center frequency. A negative value will reverse the direction of sweep. The wah center frequency can be controlled by the modulation source specified in the “Source” parameter.

Pre Low Cut

Cutting the signal in the low range before it is input to the Distortion will create a sharp distortion.

Drive

Output Level

The degree of distortion is determined by the level of input signal and the setting of “Drive.” Raising the “Drive” setting will cause the entire volume level to increase. Use the “Output Level” parameter to adjust the volume level. The “Output Level” parameter uses the signal level input to the 3-Band EQ. If clipping occurs at the 3-Band EQ, adjust the “Output Level” parameter.

021: St. Guitar Cabinet (Stereo Guitar Cabinet)

This simulates the acoustical character of a guitar amp's speaker cabinet.

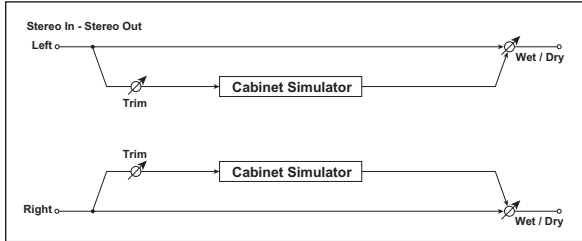

Parameter		Value	Explanation	
Trim	←	0...100	Sets the input level	
Type	←		Selects the type of the cabinet	
		TWEED - 1x12	Open-back cabinet with one 12" speaker, typically used for blues	
		TWEED - 4x10	Open-back cabinet with four 10" speakers	
		BLACK - 2x10	Open-back cabinet with two 10" speakers	
		BLACK - 2x12	American open-back cabinet with two 12" speakers	
		VOX AC15 - 1x12	Vox AC15 open-back cabinet with one 12" "Blue" speaker	
		VOX AC30 - 2x12	Vox AC30 open-back cabinet with two 12" "Blue" speakers	
		VOX AD412 - 4x12	VOX AD412 closed-back cabinet with four 12" speakers	
		UK H30 - 4x12	Closed-back classic cabinet with four 30W 12" speakers	
		UK T75 - 4x12	Closed-back cabinet with four 75W 12" speakers	
US V30 - 4x12	Closed-back cabinet with four 30W 12" speakers			
Wet/Dry	←	Dry, 1 : 99... 99 : 1, Wet	Sets the balance between the effect and the dry input	
Src	Source	Off...Tempo	Selects a modulation source for Wet/Dry	
Amt	Amount	-100...+100	Sets the modulation amount for Wet/Dry	

022: St. Bass Cabinet (Stereo Bass Cabinet)

This simulates the acoustical character of a bass amp's speaker cabinet.

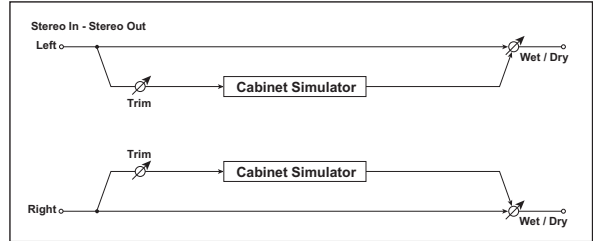

Parameter		Value	Explanation	
Trim	←	0...100	Sets the input level	
Type	Cabinet Type		Selects the cabinet type	
		LA - 4x10	Four 10" speakers / LA sound cabinet	
		MODERN - 4x10	Four 10" aluminum-cone speakers / modern cabinet	
		METAL - 4x10	Four 10" aluminum-cone speakers / modern cabinet	
		CLASSIC - 8x10	Eight 10" speakers / classic cabinet	
		UK - 4x12	Four 12" speakers / UK-manufactured cabinet	
		STUDIO - 1x15	One 15" speaker / studio combo cabinet	
		JAZZ - 1x15	One 15" speaker / jazz combo cabinet	
		VOX AC100 - 2x15	Two 15" speakers / cabinet for Vox AC100	
		US - 2x15	Two 15" speakers / US-manufactured cabinet	
		UK - 4x15	Four 15" speakers / UK-manufactured cabinet	
		LA - 1x18	One 18" speaker / LA sound cabinet	
		COMBI - 1x12 & 1x18	One 12" and one 18" speaker combination cabinet	
Wet/Dry	←	Dry, 1 : 99... 99 : 1, Wet	Sets the balance between the effect and the dry input	
Src	Source	Off...Tempo	Selects a modulation source for Wet/Dry	
Amt	Amount	-100...+100	Sets the modulation amount for Wet/Dry	

023: Bass Amp Model

This simulates a bass amp.

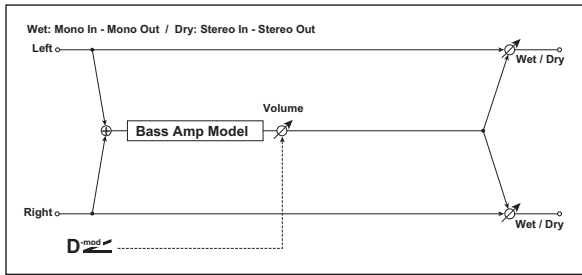

Parameter	Value	Explanation		
Amp Type	←	LA STUDIO	Selects the amplifier type An amp that is typical of the LA sound.	D-mod
		JAZZ COMBO	A combo amp favored by jazz bassists.	
		GOLD PANEL	An amp distinctive for its eye-catching gold panel and clean sound.	
		SCOOPED	An amp typical of 80's sounds.	
		VALVE2	A tube amp suitable for rock.	
		VALVE	A tube amp with the ULTRA LO switch turned ON.	
		CLASSIC	A tube amp whose basic character changes according to the setting of the value dial.	
Volume	←	0...100	Sets the output level	D-mod
Src	Source	Off...Tempo	Selects the modulation source for the output level	
Amt	Amount	-100...+100	Sets the modulation amount of the output level	
Bass	←	0...100	Sets the bass (low range) level	
Middle	←	0...100	Sets the middle (mid range) level	
Middle Range	←	0...4	Sets the mid-frequency range	
Treble	←	0...100	Sets the treble (high range) level	
Presence	←	0...100	Sets the presence (high-frequency tone)	
Wet/Dry	←	Dry, 1 : 99... 99 : 1, Wet	Sets the balance between the effect and the dry input	D-mod
Src	Source	Off...Tempo	Selects a modulation source for Wet/Dry	
Amt	Amount	-100...+100	Sets the modulation amount for Wet/Dry	

024: Bass Amp+Cabine (Bass Amp Model+Cabinet)

This simulates a bass amp and speaker cabinet.

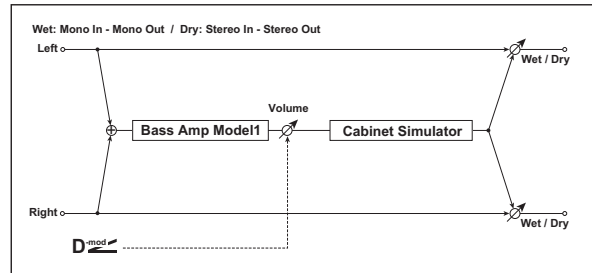

Parameter	Value	Explanation		
Amp Type	←	LA STUDIO, JAZZ COMBO, GOLD PANEL, SCOOPED, VALVE2, VALVE, CLASSIC	Selects the type of amplifier p.222	
Volume	←	0...100	Sets the output level	D-mod
Src	Source	Off...Tempo	Selects the modulation source for the output level	
Amt	Amount	-100...+100	Sets the modulation amount of the output level	
Bass	←	0...100	Sets the bass (low range) level	
Middle	←	0...100	Sets the middle (mid range) level	
Middle Range	←	0...4	Sets the mid-frequency range	
Treble	←	0...100	Sets the treble (high range) level	
Presence	←	0...100	Sets the presence (high-frequency tone)	
Cabinet	←	Off, On	Switches the cabinet simulator on/off	
Type	Cabinet Type	LA - 4x10, MODERN - 4x10, METAL - 4x10, CLASSIC - 8x10, UK - 4x12, STUDIO - 1x15, JAZZ - 1x15, VOX AC100 - 2x15, US - 2x15, UK - 4x15, LA - 1x18, COMBI - 1x12 & 1x18	Selects the cabinet type p.221	
Wet/Dry	←	Dry, 1 : 99... 99 : 1, Wet	Sets the balance between the effect and the dry input	D-mod
Src	Source	Off...Tempo	Selects a modulation source for Wet/Dry	
Amt	Amount	-100...+100	Sets the modulation amount for Wet/Dry	

Amp Type
Cabinet Type
Recommended Combinations of Bass Amp Models and Cabinets:

Amp Type	Cabinet Type
LA STUDIO	LA - 4x10, LA - 1x18
JAZZ COMBO	JAZZ - 1x15
GOLD PANEL	MODERN - 4x10
SCOOPED	METAL - 4x10
VALVE2	CLASSIC - 8x10
VALVE	CLASSIC - 8x10
CLASSIC	COMBI - 1x12 & 1x18

025: Treble Booster

This effect models a famous boost/overdrive effect that was developed in order to produce a “guitar orchestra” effect, and designed for use with the VOX AC30. You can use this to add clear boost to the signal, or apply it to an organ sound to add an overdrive that generates rich overtones. Three controls allow a broad range of settings, letting you create a wide variety of overdrive sounds.

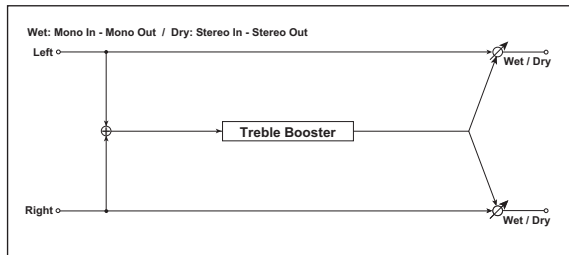

Parameter	Value	Explanation
Drive	← 1...100	Sets the gain for overdrive
Level	← 0...100	Sets the output level
Tone	← 1...100	Sets the tone for overdrive
Wet/Dry	← Dry, 1:99 ... 99:1, Wet	Sets the balance between the effect and the dry input
Src	Source	Selects a modulation source for Wet/Dry
Amt	Amount	Sets the modulation amount for Wet/Dry

026: Tube PreAmp Model (Tube PreAmp Modeling)

This effect simulates a two-stage vacuum tube preamp. You can adjust individual settings for two vacuum tubes connected in series. This lets you create the warm sound typical of vacuum tubes.

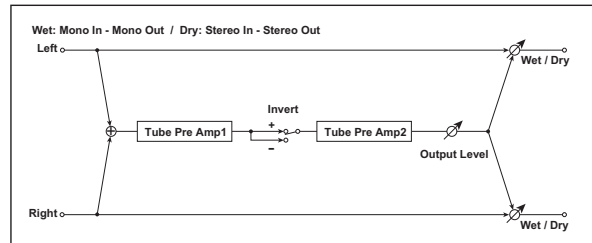

Parameter	Value	Explanation	
1 LCut[Hz]	Tube1 Low Cut [Hz]	Thru, 21...8.00k	Sets the cutoff frequency for the low cut filter of stage 1
1 HCut[Hz]	Tube1 High Cut [Hz]	53...20.00k, Thru	Sets the cutoff frequency for the high cut filter of stage 1
1 Gain[Hz]	Tube1 Gain [dB]	-24.0...+24.0	Sets the input gain for stage 1
1 Saturate	Tube1 Saturation [%]	0...100	Sets the input/output response for stage 1 p.223
1 Bias	Tube1 Bias	0...100	Sets the bias voltage for stage 1 p.224
1 Phase	Tube1 Phase	Normal, Wet Invert	Turns phase reversal on/off p.224
2 LCut[Hz]	Tube2 Low Cut [Hz]	Thru, 21...8.00k	Sets the cutoff frequency for the low cut filter of stage 2
2 HCut[Hz]	Tube2 High Cut [Hz]	53...20.00k, Thru	Sets the cutoff frequency for the high cut filter of stage 2
2 Gain[Hz]	Tube2 Gain [dB]	-24.0...+24.0	Sets the input gain for stage 2
2 Saturate	Tube2 Saturation [%]	0...100	Sets the input/output response for stage 2 p.223
2 Bias	Tube2 Bias	0...100	Sets the bias voltage for stage 2 p.224
2Out[dB]	Tube2 Output Level [dB]	-48.0...+0.0	Sets the output level
Wet/Dry	←	Dry, 1 : 99... 99 : 1, Wet	Sets the balance between the effect and the dry input D-mod
Src	Source	Off...Tempo	Selects a modulation source for Wet/Dry
Amt	Amount	-100...+100	Sets the modulation amount for Wet/Dry

Saturation [%]

With higher settings of this value, the waveform will change at high gain levels, tending to cause distortion. Lower settings of this value will produce linear response.

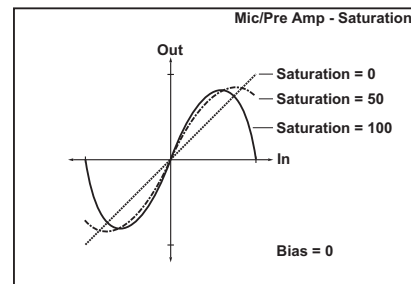

Tube1 Bias

This expresses the effect that changes in vacuum tube bias have on the distortion of the waveform. Higher settings of this value will produce distortion even at low gain levels. Since this will also change the overtone structure, you can use it to control the tonal character.

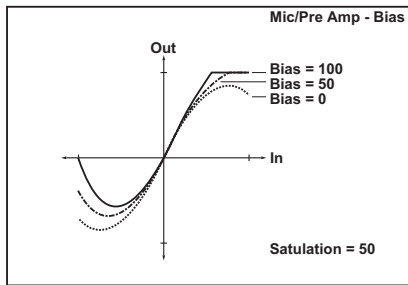

Tube1 Phase

With the Wet Invert setting, the phase of the signal will be inverted between stage 1 and stage 2. Since “Bias” is applied to the inverted signal in stage 2, this will change the tonal character.

027: St.TubePreAmp (Stereo Tube PreAmp Modeling)

This is a stereo vacuum tube preamp simulator (See “026: Tube PreAmp Model (Tube PreAmp Modeling)” on page 223.).

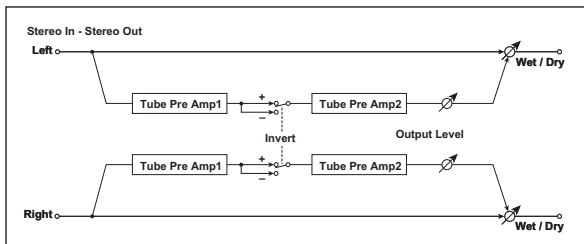

028: Mic Model+PreAmp (Mic Modeling + PreAmp)

This effect simulates a mic and vacuum tube preamp. You can choose from various types of mic and positions to create differing sonic characters.

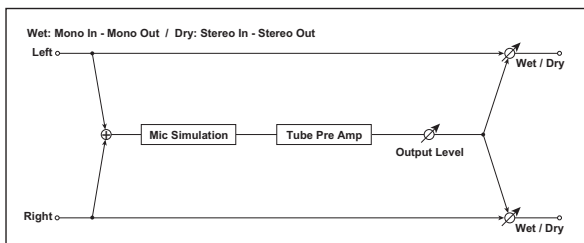

Paramter	Value	Explanation
Mic	Mic Type	Vintage Dynamic, Multi Condenser, Perc Condenser, Drums Dynamic, Vocal Dynamic, Multi Dynamic, Vocal Condenser, Vocal Tube, Kick Dynamic
Position	Mic Position	Close, On, Off, Far

Paramter	Value	Explanation
TLCut[Hz]	Tube Low Cut [Hz]	Thru, 21...8.00k
THCut[Hz]	Tube High Cut [Hz]	53...20.00k, Thru
T Gain[Hz]	Tube Gain [dB]	-24.0...+24.0
T Saturate	Tube Saturation [%]	0...100
T Bias	Tube Bias	0...100
T Out[dB]	Tube Output Level [dB]	-48.0...+0.0
Wet/Dry		Dry, 1 : 99... 99 : 1, Wet
Src	Source	Off...Tempo
Amt	Amount	-100...+100

Mic Position

This expresses the effect that the mic position has on the sound. The Close setting is the closest mic position, and the Far setting is the farthest.

029: Stereo Phaser

This effect creates a swell by shifting the phase. It is very effective on electric piano sounds. You can add spread to the sound by offsetting the phase of the left and right LFOs from each other.

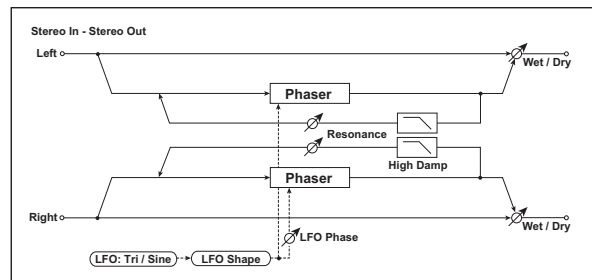

Paramter	Value	Explanation
LFO	LFO Waveform	Tri (Triangle), Sine
Shape	LFO Shape	-100...+100
Phase	Phase [deg]	-180...+180
LFO [Hz]	LFO Freq [Hz]	0.02...20.00
Src	Source	Off...Tempo
Amt	Amount	-20.00... +20.00
MIDI Sync	BPM/MIDI Sync	Off, On
BPM		MIDI, 40.00... 300.00
Note	Base Note	
Time	Times	x1...x32
Depth		0...100

Src	Source	Off...Tempo	Selects the modulation source for the LFO modulation depth	
Amt	Amount	-100...+100	Sets the modulation amount of the LFO modulation depth	
Resonance	←	-100...+100	Sets the resonance amount p.225	
HiDamp[%]	High Damp [%]	0...100	Sets the resonance damping amount in the high range p.225	
Manual	←	0...100	Sets the frequency where the effect is applied	D ^{mod}
Src	Source	Off...Tempo	Selects the modulation source for the LFO modulation	
Amt	Amount	-100...+100	Sets the modulation amount of the LFO modulation	
Wet/Dry	←	-Wet...-99 : 1, Dry, 99 : 1...Wet	Sets the balance between the effect and the dry input p.216, p.225	D ^{mod}
Src	Source	Off...Tempo	Selects a modulation source for Wet/Dry	
Amt	Amount	-100...+100	Sets the modulation amount for Wet/Dry	

Resonance

Wet/Dry

The peak shape of the positive and negative Feedback value is different. The harmonics will be emphasized when the effect sound is mixed with the dry sound, if you set a positive value for both “Resonance” and “Wet/Dry,” and if you set a negative value for both “Resonance” and “Wet/Dry.”

High Damp [%]

This parameter sets the amount of damping of the resonance in the high range. Increasing the value will cut high-range harmonics.

030: SmallPHASE (Small Phaser)

This models a classic phaser that was born in New York during the 1970s. With a warm, rich tone, it is also loved by many electric piano players.

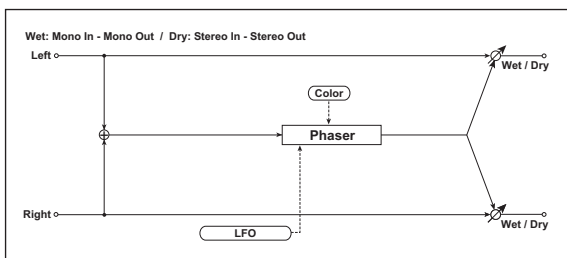

Paramter	Value	Explanation		
Speed [Hz]	←	0.10...10.0	Sets the speed of the LFO	
Color	←	Off, On	Switches the tone of the phaser sound p.225	
Wet/Dry	←	-Wet...-1 : 99, Dry, 1 : 99...Wet	Sets the balance between the effect and the dry input p.216, p.225	D ^{mod}
Src	Source	Off...Tempo	Selects a modulation source for Wet/Dry	
Amt	Amount	-100...+100	Sets the modulation amount for Wet/Dry	

Color

This lets you choose between two types of phaser sound. Turning this On produces a deeper phase shift effect with a distinctive modulation.

031: Orange PHASE (Orange Phaser)

This models a standard model of analog phaser that achieved great popularity. It gives a sense of movement to electric piano sounds, adding a rich-sounding phase shift effect.

032: Black PHASE (Black Phaser)

This models a Danish-made four-stage phaser that featured a wide range.

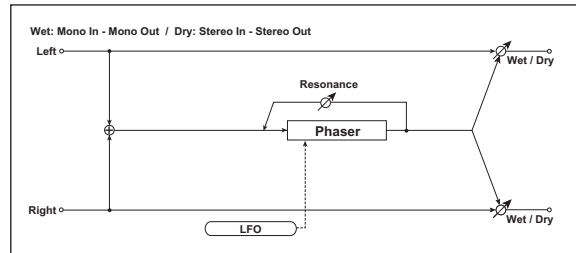

Paramter	Value	Explanation		
Speed [Hz]	←	0.10...10.0	Sets the speed of the LFO	
Depth	←	0...100	Sets the depth of LFO modulation	
Manual	←	1...100	Sets the frequency where the effect is applied	
Resonance	←	0...100	Sets the resonance amount	
Wet/Dry	←	-Wet...-1 : 99, Dry, 1 : 99...Wet	Sets the balance between the effect and the dry input	D ^{mod}
Src	Source	Off...Tempo	Selects a modulation source for Wet/Dry	
Amt	Amount	-100...+100	Sets the modulation amount for Wet/Dry	

033: U-VIBE

This models a famous chorus/vibrato pedal effect. Simulating a rotary speaker, this effect produced a fascinatingly lush tone.

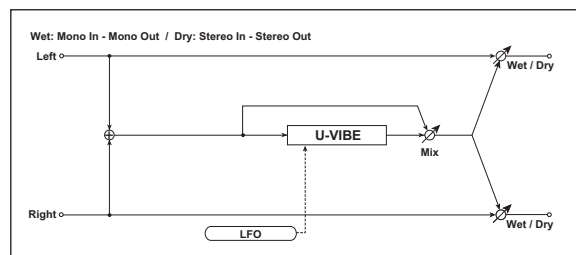

Paramter	Value	Explanation		
Speed [Hz]	←	0.10...10.0	Sets the speed of the vibration	
Depth	←	0...100	Sets the depth of vibration	
Mix	←	0...100	Sets the effect mix level	
Wet/Dry	←	-Wet...-1 : 99, Dry, 1 : 99...Wet	Sets the balance between the effect and the dry input p.226	D ^{mod}
Src	Source	Off...Tempo	Selects a modulation source for Wet/Dry	
Amt	Amount	-100...+100	Sets the modulation amount for Wet/Dry	

Mix

Wet/Dry

The Mix parameter specifies the amount of effect sound relative to the direct sound. A setting of 0 produces the direct sound, a setting of about 50 produces chorus, and a setting of 100 produces a vibrato effect. If you set the Wet/Dry parameter to Wet, the sound will be output with the mix balance specified by Mix.

034: St. Random Phaser (Stereo Random Phaser)

This is a stereo phaser. The effect uses a step-shape waveform and random LFO for modulation, creating a unique phasing effect.

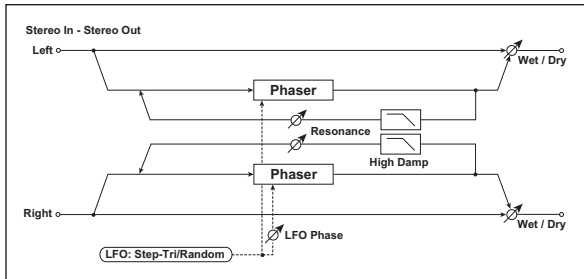

Paramter	Value	Explanation
LFO	LFO Waveform	Step-Tri, Step-Sin, Random
Phase [deg]	←	-180...+180
LFO [Hz]	LFO Freq [Hz]	0.02...20.00
Src	Source	Off...Tempo
Amt	Amount	-20.00...+20.00
Step [Hz]	Step Freq [Hz]	0.05...50.00
Amt	Amount	-50.00...+50.00
MIDI Sync	BPM/MIDI Sync	Off, On
BPM	←	MIDI, 40.00...300.00
Base Note	←	MIDI note icon
Times	←	x1...x32
Step	Step Base Note	MIDI note icon
Times	←	x1...x32
Depth	←	0...100
Resonance	←	-100...+100
HiDamp[%]	High Damp [%]	0...100
Manual	←	0...100

Src	Source	Off...Tempo	Selects the modulation source for the LFO modulation
Amt	Amount	-100...+100	Sets the modulation amount of the LFO modulation
Wet/Dry	←	-Wet...-99 : 1, Dry, 99 : 1...Wet	Sets the balance between the effect and the dry input p.216, p.225
Src	Source	Off...Tempo	Selects a modulation source for Wet/Dry
Amt	Amount	-100...+100	Sets the modulation amount for Wet/Dry

035: St. Env Phaser (Stereo Envelope Phaser)

This stereo phaser uses an envelope generator for modulation. You will obtain the same pattern of phasing each time you play. You can also control the Phaser directly using the modulation source.

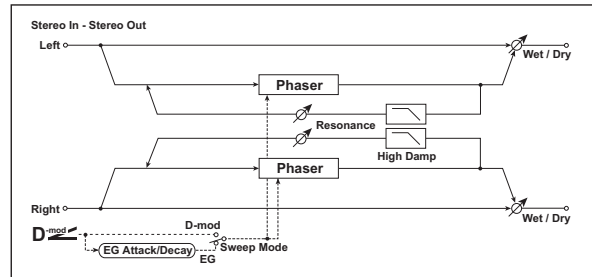

Paramter	Value	Explanation
L ManuBtm	L Manual Bottom	0...100
L ManuTop	L Manual Top	0...100
R Man Btm	R Manual Bottom	0...100
R ManuTop	R Manual Top	0...100
Sweep	Sweep Mode	EG, Dmod
Src	Source	Off...Tempo
EG Attack	←	1...100
EG Decay	←	1...100
Resonance	←	-100...+100
HiDamp[%]	High Damp [%]	0...100
Wet/Dry	←	-Wet...-99 : 1, Dry, 99 : 1...Wet
Src	Source	Off...Tempo
Amt	Amount	-100...+100

036: 2Voice Resonator

This effect resonates the input signal at a specified pitch. You can set the pitch, output level, and pan settings for two resonators individually. You can control the resonance intensity via an LFO.

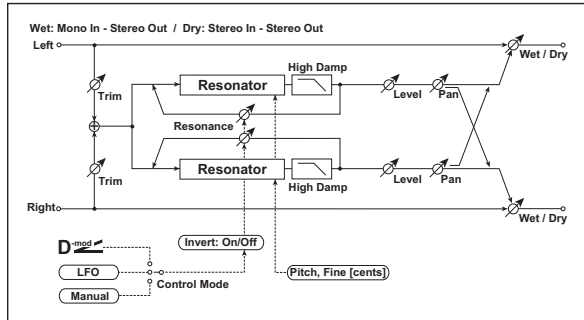

Parameter	Value	Explanation	
Control	Control Mode	Manual, LFO, Dmod	Switches the controls of resonance intensity p.227
Mod Invert	LFO/Dmod Invert	Off, On	Reverses the Voice 1 and 2 control when LFO/Dmod is selected p.227
LFO [Hz]	LFO Freq [Hz]	0.02...20.00	Sets the speed of the LFO
Dmod Src	Dmod Source	Off...Tempo	Selects the modulation source that controls resonance intensity
MIDI Sync	BPM/MIDI Sync	Off, On	When this is on, the LFO speed is set by BPM, Base Note, and Times, instead of Frequency p.213
BPM	←	MIDI, 40.00...300.00	MIDI syncs to the system tempo; 40–300 sets the tempo manually for this individual effect p.213
Base Note	←		Selects the type of notes that specify the LFO speed p.213
Times	←	x1...x32	Sets the number of notes that specify the LFO speed p.213
Mod. Depth	←	-100...+100	Sets the amount of resonance intensity control via LFO/Dmod
Trim	←	0...100	Sets the input level at the resonator
V1 Pitch	Voice1 Pitch	C0...B8	Sets the voice1 Pitch for resonance p.227
Fine [c]	Voice1 Fine [cents]	-50...+50	Fine-adjusts the voice 1 pitch for resonance p.227
Lvl	Level	0...100	Sets the Voice1 output level
V1 Reso	Voice1 Resonance	-100...+100	Sets the intensity of resonance when Control Mode = Manual p.227
HDamp[%]	High Damp [%]	0...100	Sets the damping amount of resonant sound in the high range p.227
Pan	←	L6...L1, C, R1...R6	Sets the Voice1 stereo image
V2 Pitch	Voice2 Pitch	C0...B8	Sets the voice 2 Pitch for resonance p.227
Fine [c]	Fine [cents]	-50...+50	Fine-adjusts the voice 2 pitch for resonance p.227
Lvl	Level	0...100	Sets the Voice2 output level
V2 Reso	Voice2 Resonance	-100...+100	Sets the intensity of resonance when Control Mode = Manual p.227

HDamp[%]	High Damp [%]	0...100	Sets the damping amount of resonant sound in the high range p.227	
Pan	←	L6...L1, C, R1...R6	Sets the Voice2 stereo image	
Wet/Dry	←	Dry, 1 :99... 99 : 1, Wet	Sets the balance between the effect and the dry input	
Src	Source	Off...Tempo	Selects a modulation source for Wet/Dry	
Amt	Amount	-100...+100	Sets the modulation amount for Wet/Dry	

Control Mode

Voice 1 Resonance

Voice 2 Resonance

This parameter determines the resonance intensity.

When “Control Mode” = Manual, the “Resonance” parameter sets the intensity of resonance. If the “Resonance” parameter has a negative value, harmonics will be changed, and resonance will occur at a pitch one octave lower.

When “Control Mode” = LFO, the intensity of resonance varies according to the LFO. The LFO sways between positive and negative values, causing resonance to occur between specified pitches an octave apart in turn.

When “Control Mode” = Dmod, the resonance is controlled by the dynamic modulation source. If P.Bend is assigned as the modulation source, the pitch an octave higher and lower can be controlled, similar to when LFO is selected for Control Mode.

LFO/Dmod Invert

When “Control Mode” = LFO or Dmod, the controlled phase of either Voice 1 or 2 will be reversed. When the resonance pitch is set for Voice 1 (Resonance has a positive value), Voice 2 will resonate at a pitch an octave below (Resonance has a negative value).

Voice 1 Pitch

Voice 1 Fine [cents]

Voice 2 Pitch

Voice 2 Fine [cents]

The Pitch parameter specifies the pitch of resonance by note name. The “Fine” parameter allows for fine adjustment in steps of cents.

High Damp [%]

This sets the amount of damping amount for the high frequencies of the resonant sound. Lower values create a metallic sound with a higher range of harmonics.

037: Stereo Tremolo

This effect modulates the volume level of the input signal. The effect is stereo, and offsetting the LFO of the left and right phases from each other produces a tremolo effect between left and right.

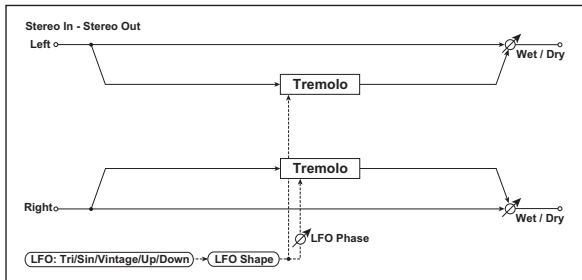

Paramter	Value	Explanation
LFO	LFO Waveform Tri (Triangle), Sine, Vntage (Vintage), Up, Down	Selects the LFO Waveform p.228
Shape	LFO Shape -100...+100	Changes the curvature of the LFO Waveform p.214
Phase	LFO Phase [deg] -180...+180	Sets the LFO phase difference between the left and right p.228
LFO [Hz]	LFO Freq [Hz] 0.02...20.00	Sets the speed of the LFO p.216
Src	LFO Source Off...Tempo	Selects a modulation source for LFO speed
Amt	LFO Amount -20.00...+20.00	Sets the modulation amount of LFO speed
MIDI Sync	BPM/MIDI Sync Off, On	When this is on, the LFO speed is set by BPM, Base Note, and Times, instead of Frequency p.213
BPM	← MIDI, 40.00...300.00	MIDI syncs to the system tempo; 40-300 sets the tempo manually for this individual effect p.213
Base Note	← [Note Icon]	Selects the type of notes that specify the LFO speed p.213
Times	← x1...x32	Sets the number of notes that specify the LFO speed p.213
Depth	← 0...100	Sets the depth of LFO modulation
Src	Source Off...Tempo	Selects the modulation source of the depth of modulation
Amt	Amount -100...+100	Sets the modulation amount of the depth of modulation
Wet/Dry	← Dry, 1 : 99... 99 : 1, Wet	Sets the balance between the effect and the dry input
Src	Source Off...Tempo	Selects a modulation source for Wet/Dry
Amt	Amount -100...+100	Sets the modulation amount for Wet/Dry

LFO Waveform

This parameter sets the basic shape of the LFO. The **Vintage** waveform models classic guitar-amp tremolo.

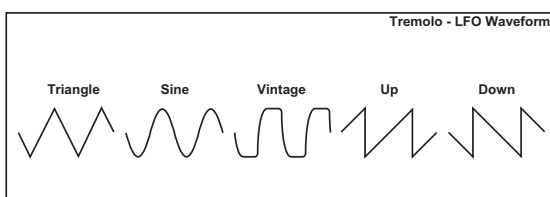

LFO Phase [deg]

This parameter determines the difference between the left and right LFO phases. A higher value will simulate the auto-pan effect in which the sound is panned between left and right.

038: TEXTREM (TEX Tremolo)

This models the highly-acclaimed tremolo circuit that was built into a US-made combo amp. The Spread setting lets you create a pan effect that wavers between left and right.

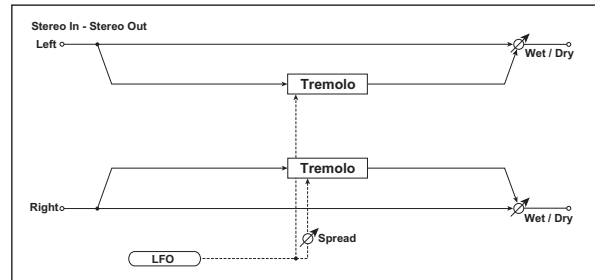

Paramter	Value	Explanation
Speed [Hz]	← 0.10...10.0	Sets the tremolo speed
Depth	← 0...100	Select the tremolo depth
Spread	← 0...100	Sets the width of the stereo image of the effect sound
Level Adjust	← 1...100	Sets the output level
Wet/Dry	← -Wet... -1 : 99, Dry, 1 : 99...Wet	Sets the balance between the effect and the dry input
Src	Source Off...Tempo	Selects a modulation source for Wet/Dry
Amt	Amount -100...+100	Sets the modulation amount for Wet/Dry

039: St. Env. Tremolo (Stereo Envelope Tremolo)

This effect uses the input signal level to modulate a stereo tremolo effect (LFO volume modulation). For instance, you can create a tremolo effect that becomes deeper and faster as the input gets more quiet.

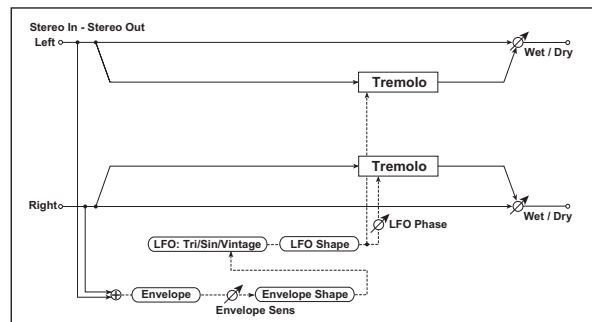

Paramter	Value	Explanation
Env Sens	Envelope Sens 0...100	Sets the envelope's sensitivity to the input signal
Env Shape	Envelope Shape -100...+100	Sets the envelope's curvature
LFO	LFO Waveform Tri (Triangle), Sine, Vntage (Vintage)	Selects the LFO Waveform
Shape	LFO Shape -100...+100	Changes the curvature of the LFO Waveform p.214
Phaes	LFO Phase [deg] -180...+180	Sets the LFO phase difference between the left and right p.228
LFO [Hz]	LFO Freq [Hz] 0.02...20.00	Sets the speed of the LFO p.229

EnvAmount [Hz]	Envelope Amount [Hz]	-20.00...+20.00	Sets the amount added to or subtracted from the Frequency when the envelope is at maximum p.229	
Depth	Tremolo Depth	0...100	Sets the initial amount of tremolo p.229	
EnvAmount-Depth	Envelope Amount Depth	-100...+100	Sets the amount added to or subtracted from the Depth when the envelope is at maximum p.229	
Wet/Dry	←	Dry, 1 : 99... 99 : 1, Wet	Sets the balance between the effect and the dry input	D ^{mod}
Src	Source	Off...Tempo	Selects a modulation source for Wet/Dry	
Amt	Amount	-100...+100	Sets the modulation amount for Wet/Dry	

LFO Freq [Hz]
Envelope Amount [Hz]
Tremolo Depth
Tremolo Amount

The graphic below shows an example of tremolo modulation with negative modulation of both “Depth” and “Frequency.” At the start of the note, the input is at maximum volume. This slows down the LFO “Frequency” to **1.0Hz**, but also modulates the “Depth” to **0** so the tremolo doesn’t have any effect.

As the input volume dies down, the “Frequency” speeds up; the “Depth” also increases, making the tremolo effect increasingly audible. When the input volume approaches silence, the “Depth” is at its maximum (**100**) and “Frequency” is at **8Hz**.

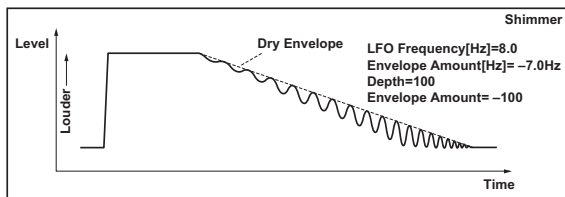

040: Stereo Auto Pan

This is a stereo-in, stereo-out auto-panner. The Phase and Shape parameters let you create various panning effects, such as making the left and right inputs seem to chase each other around the stereo field.

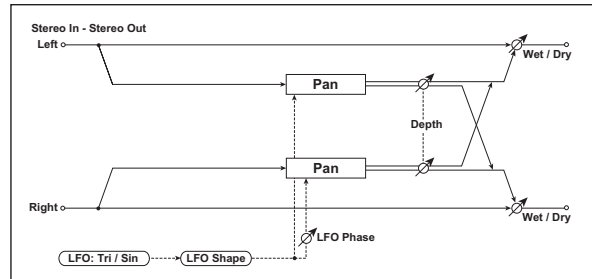

Parameter	Value	Explanation	
LFO	LFO Waveform	Tri (Triangle), Sine	Selects the LFO Waveform
Shape	LFO Shape	-100...+100	Changes the curvature of the LFO Waveform p.229
Phase	LFO Phase [deg]	-180...+180	Sets the LFO phase difference between the left and right p.229
LFO [Hz]	LFO Freq [Hz]	0.02...20.00	Sets the speed of the LFO p.216
Src	LFO Source	Off...Tempo	Selects a modulation source for LFO speed
Amt	LFO Amount	-20.00...+20.00	Sets the modulation amount of LFO speed
MIDI Sync	LFO BPM/MIDI Sync	Off, On	When this is on, the LFO speed is set by BPM, Base Note, and Times, instead of Frequency p.213
BPM	←	MIDI, 40.00... 300.00	MIDI syncs to the system tempo; 40–300 sets the tempo manually for this individual effect p.213
Base Note	←		Selects the type of notes that specify the LFO speed p.213
Times	←	x1...x32	Sets the number of notes that specify the LFO speed p.213
Depth	←	0...100	Sets the depth of LFO modulation
Src	Source	Off...Tempo	Selects the modulation source of the depth of modulation
Amt	Amount	-100...+100	Sets the modulation amount of the depth of modulation
Wet/Dry	←	Dry, 1 : 99... 99 : 1, Wet	Sets the balance between the effect and the dry input
Src	Source	Off...Tempo	Selects a modulation source for Wet/Dry
Amt	Amount	-100...+100	Sets the modulation amount for Wet/Dry

LFO Shape

You can change the panning curve by modifying the LFO’s “Shape.”

LFO Phase [deg]

This determines the phase difference between the left and right LFOs. When you gradually change the value away from 0, the sounds from the left and right channels will seem to chase each other around. If you set the parameter to +180 or -180, the sounds from each channel will cross over each other. You’ll only hear the effect of this parameter if the input is true stereo, with different signals in the left and right channels.

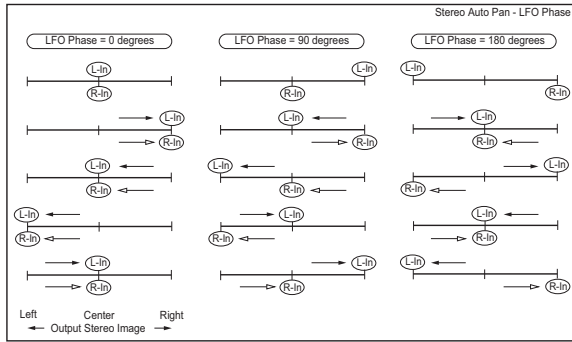

041: St. Phaser+Trml (Stereo Phaser + Tremolo)

This effect combines a stereo phaser and tremolo, with linked LFOs. Swelling phaser modulation and tremolo effects synchronize with each other, creating a soothing modulation effect particularly suitable for electric piano.

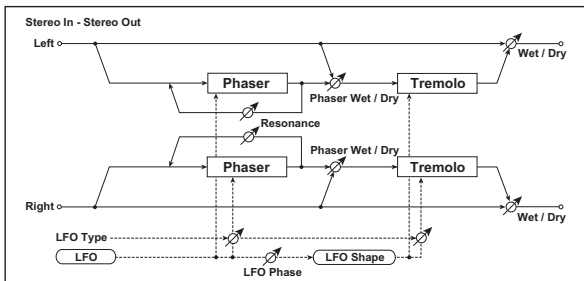

Parameter	Value	Explanation
Type	LFO Phase Type	Selects the type of the tremolo and phaser LFOs p.230 Phs-Trml, Phs-Spin, Phs-T LR, P LR-Trml, P LR-Spin, P LR-T LR
LFO Phase [deg]	← -180...+180	Sets the phase difference between the tremolo and phaser LFOs p.230
LFO [Hz]	LFO Freq [Hz] 0.02...20.00	Sets the speed of the LFO p.216
Src	Source Off...Tempo	Selects a modulation source for LFO speed
Amt	Amount -20.00...+20.00	Sets the LFO speed modulation amount
MIDI Sync	BPM/MIDI Sync Off, On	When this is on, the LFO speed is set by BPM, Base Note, and Times, instead of Frequency p.213
BPM	← MIDI, 40.00...300.00	MIDI syncs to the system tempo; 40-300 sets the tempo manually for this individual effect p.213
Base Note	←	Selects the type of notes that specify the LFO speed p.213
Times	← x1...x32	Sets the number of notes that specify the LFO speed p.213
Phs Depth	Phaser Depth 0...100	Sets the phaser modulation depth
Src	Source Off...Tempo	Selects the modulation source for the phaser modulation depth
Amt	Amount -100...+100	Sets the modulation amount for the phaser modulation depth

Phs Manu	Phaser Manual	0...100	Sets the phaser frequency range
Phs Reso	Phaser Resonance	-100...+100	Sets the phaser resonance amount
Phs W/D	Phaser Wet/Dry	-Wet...-2.98, Dry, 2.98...Wet	Sets the balance between the phaser effect and dry sounds p.230
Trml Shape	Tremolo Shape	-100...+100	Sets the degree of the tremolo LFO shaping
Trml Depth	Tremolo Depth	0...100	Sets the tremolo modulation depth
Src	Source	Off...Tempo	Selects the modulation source for the tremolo modulation depth
Amt	Amount	-100...+100	Sets the modulation amount of the tremolo modulation depth
Wet/Dry	←	Dry, 1 : 99... 99 : 1, Wet	Sets the balance between the effect and the dry input p.230
Src	Source	Off...Tempo	Selects a modulation source for Wet/Dry
Amt	Amount	-100...+100	Sets the modulation amount for Wet/Dry

Type

LFO Phase [deg]

Select the type of phaser LFO and tremolo LFO for the “Type” parameter. How the effect sound moves or rotates depends on the type of LFO. Selecting “LFO Phase” enables you to offset the timing of the phaser peak and control a subtle movement and rotation of the sound.

Phaser Wet/Dry

Wet/Dry

“(Phaser) Wet/Dry” sets the balance between the phaser output and the dry sound. “(OUTPUT) Wet/Dry” sets the balance between the final phaser and tremolo output level and the dry sound.

042: St. Ring Modulator (Stereo Ring Modulator)

This effect creates a metallic sound by applying the oscillators to the input signal. Use the LFO or Dynamic Modulation to modulate the oscillator to create a radical modulation. Matching the oscillator frequency with a note number will produce a ring modulation effect in specific key ranges.

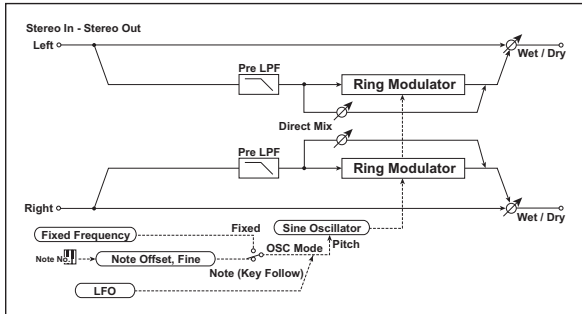

Parameter	Value	Explanation	
OSC Mode	←	Fixed, Note Follow	Switching between specifying the oscillator frequency and using a note number p.231
Pre LPF	←	0...100	Sets the damping amount of the high range input to the ring modulator p.231
Fixed[Hz]	Fixed Freq [Hz]	0...12.0(k)	Sets the oscillator frequency when OSC Mode is set to Fixed p.231
Src	Source	Off...Tempo	Selects the modulation source for the oscillator frequency when OSC Mode is set to Fixed
Amt	Amount	-12.00k...+12.00k	Sets the modulation amount of the oscillator frequency when OSC Mode is set to Fixed
NoteOffset	Note Offset	-48...+48	Sets the pitch difference from the original note when OSC Mode is set to Note (Key Follow) p.231
Note Fine	←	-100...+100	Fine-adjusts the oscillator frequency p.231
LFO Depth	←	0...100	Sets the depth of LFO modulation for the oscillator frequency
Src	Source	Off...Tempo	Selects the modulation source of the depth of modulation
Amt	Amount	-100...+100	Sets the modulation amount of the depth of modulation
LFO [Hz]	LFO Freq [Hz]	0.02...20.00	Sets the speed of the LFO p.216
Src	Source	Off...Tempo	Selects a modulation source for LFO speed
Amt	Amount	-20.00...+20.00	Sets the modulation amount of LFO speed
MIDI Sync	BPM/MIDI Sync	Off, On	When this is on, the LFO speed is set by BPM, Base Note, and Times, instead of Frequency p.213
BPM	←	MIDI, 40.00...300.00	MIDI syncs to the system tempo; 40-300 sets the tempo manually for this individual effect p.213
Base Note	←		Selects the type of notes that specify the LFO speed p.213

Times	←	x1...x32	Sets the number of notes that specify the LFO speed p.213	
Direct Mix	←	0...100	Direct signal (after passing through the pre-low-pass filter) mixed into the ring modulation output	
Wet/Dry	←	Dry, 1 : 99...99 : 1, Wet	Sets the balance between the effect and the dry input	
Src	Source	Off...Tempo	Selects a modulation source for Wet/Dry	
Amt	Amount	-100...+100	Sets the modulation amount for Wet/Dry	

OSC Mode

This parameter determines whether or not the oscillator frequency follows the note number.

Pre LPF

This parameter enables you to set the damping amount of the high range sound input to the ring modulator. If the input sound contains lots of harmonics, the effect may sound dirty. In this case, cut a certain amount of high range.

Fixed Freq [Hz]

This parameter sets the oscillator frequency when "OSC Mode" is set to Fixed.

Note Offset

Note Fine

These parameters for the oscillator are used when "OSC Mode" is set to Note (Key Follow). The "Note Offset" sets the pitch difference from the original note in semitone steps. The "Note Fine" parameter fine-adjusts the pitch in cent steps. Matching the oscillator frequency with the note number produces a ring modulation effect in the correct key.

043: P4EQ - Exciter (Parametric 4-Band EQ - Exciter)

This effect combines a mono four-band parametric equalizer and an exciter.

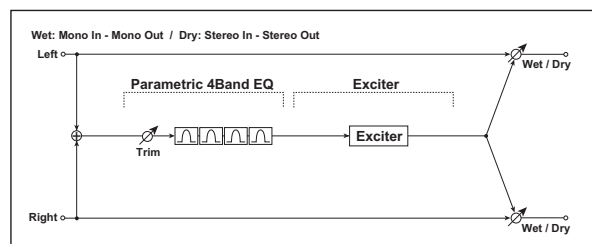

Parameter	Value	Explanation	
Parametric 4-Band EQ			
E Trim	Trim	0...100	Sets the parametric EQ input level
E B1 F[Hz]	Band1 Cutoff [Hz]	20...1.00k	Sets the center frequency of Band 1
Q	Band1Q	0.5...10.0	Sets the bandwidth of Band 1 p.211
Gain[dB]	Band1 Gain [dB]	-18...+18	Sets the gain of Band 1
E B2 F[Hz]	Band2 Cutoff [Hz]	50...5.00k	Sets the center frequency of Band 2
Q	Band2 Cutoff [Hz]	0.5...10.0	Sets the bandwidth of Band 2 p.211
Gain[dB]	Band2 Cutoff [Hz]	-18...+18	Sets the gain of Band 2
E B3 F[Hz]	Band3 Cutoff [Hz]	300...10.00k	Sets the center frequency of Band 3
Q	Band3 Q	0.5...10.0	Sets the bandwidth of Band 3 p.211

Gain[dB]	Band3 Gain [dB]	-18...+18	Sets the gain of Band 3	
E B4 F[Hz]	Band4 Cutoff [Hz]	500...20.00k	Sets the center frequency of Band 4	
Q	Band4 Q	0.5...10.0	Sets the bandwidth of Band 4	p.211
Gain[dB]	Band4 Gain [dB]	-18...+18	Sets the gain of Band 4	
Exciter				
X Blend	Exciter Blend	-100...+100	Sets the intensity (depth) of the Exciter effect	
Frequency	Emphasis Frequ	0...70	Sets the frequency range to be emphasized	p.212
Wet/Dry	←	Dry, 1 : 99... 99 : 1, Wet	Sets the balance between the effect and the dry input	D ^{mod}
Src	Source	Off...Tempo	Selects a modulation source for Wet/Dry	
Amt	Amount	-100...+100	Sets the modulation amount for Wet/Dry	

044: P4EQ - Wah (Parametric 4-Band EQ - Wah/Auto Wah)

This effect combines a mono four-band parametric equalizer and a wah. You can change the order of the connection.

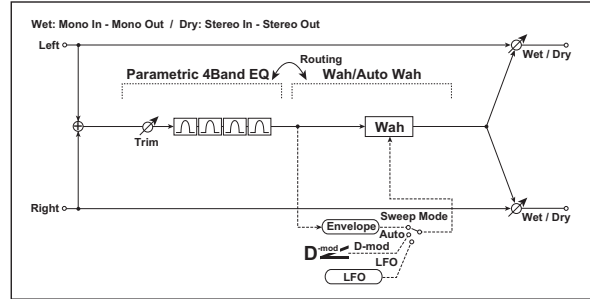

Parameter	Value	Explanation	
Parametric 4-Band EQ			
E Trim	Trim	0...100	Sets the parametric EQ input level
E B1 F[Hz]	Band1 Cutoff [Hz]	20...1.00k	Sets the center frequency of Band 1
Q	Band1 Q	0.5...10.0	Sets the bandwidth of Band 1
Gain[dB]	Band1 Gain [dB]	-18...+18	Sets the gain of Band 1
E B2 F[Hz]	Band2 Cutoff [Hz]	50...5.00k	Sets the center frequency of Band 2
Q	Band2 Q	0.5...10.0	Sets the bandwidth of Band 2
Gain[dB]	Band2 Gain [dB]	-18...+18	Sets the gain of Band 2
E B3 F[Hz]	Band3 Cutoff [Hz]	300...10.00k	Sets the center frequency of Band 3
Q	Band3 Q	0.5...10.0	Sets the bandwidth of Band 3
Gain[dB]	Band3 Gain [dB]	-18...+18	Sets the gain of Band 3
E B4 F[Hz]	Band4 Cutoff [Hz]	500...20.00k	Sets the center frequency of Band 4
Q	Band4 Q	0.5...10.0	Sets the bandwidth of Band 4
Gain[dB]	Band4 Gain [dB]	-18...+18	Sets the gain of Band 4
Wah			
W Freq Btm	Frequency Bottom	0...100	Sets the lower limit of the wah center frequency
Freq Top	Frequency Top	0...100	Sets the upper limit of the wah center frequency
W Sweep	Sweep Mode	Auto, Dmod, LFO	Selects the control from auto-wah, modulation source, and LFO
Src	Source	Off...Tempo	Selects the modulation source for the wah when Sweep Mode=Dmod
W LFO[Hz]	LFO Freq [Hz]	0.02...20.00	Sets the speed of the LFO
Reso	Resonance	0...100	Sets the resonance amount
LPF	←	Off, On	Switches the wah low pass filter on and off
W Wet/Dry	[Wah]Wet/Dry	Dry, 1 : 99... 99 : 1, Wet	Sets the wah effect balance
Src	[Wah]Source	Off...Tempo	Selects the Wet/Dry modulation source for the wah
Amt	[Wah]Amount	-100...+100	Sets the Wet/Dry modulation amount for the wah
Route	Routing	P4EQ → Wah, Wah → P4EQ	Changes the order of the parametric equalizer and wah connection

Wet/Dry	←	Dry, 1 : 99... 99 : 1, Wet	Sets the balance between the effect and the dry input	D ^{mod}
Src	Source	Off...Tempo	Selects a modulation source for Wet/Dry	
Amt	Amount	-100...+100	Sets the modulation amount for Wet/Dry	

045: P4EQ - Phaser (Parametric 4-Band EQ - Phaser)

This effect combines a mono four-band parametric equalizer and a phaser.

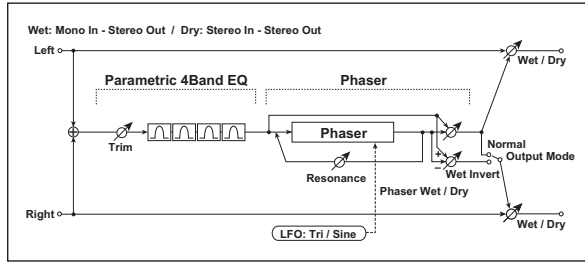

Parameter	Value	Explanation		
Parametric 4-Band EQ				
E Trim	Trim	0...100	Sets the parametric EQ input level	
E B1 F[Hz]	Trim	20...1.00k	Sets the center frequency of Band 1	
Q	Band1 Cutoff [Hz]	0.5...10.0	Sets the bandwidth of Band 1 p.211	
Gain[dB]	Band1 Q	-18...+18	Sets the gain of Band 1	
E B2 F[Hz]	Band1 Gain [dB]	50...5.00k	Sets the center frequency of Band 2	
Q	Band2 Cutoff [Hz]	0.5...10.0	Sets the bandwidth of Band 2 p.211	
Gain[dB]	Band2 Q	-18...+18	Sets the gain of Band 2	
E B3 F[Hz]	Band2 Gain [dB]	300...10.00k	Sets the center frequency of Band 3	
Q	Band3 Cutoff [Hz]	0.5...10.0	Sets the bandwidth of Band 3 p.211	
Gain[dB]	Band3 Q	-18...+18	Sets the gain of Band 3	
E B4 F[Hz]	Band3 Gain [dB]	500...20.00k	Sets the center frequency of Band 4	
Q	Band4 Cutoff [Hz]	0.5...10.0	Sets the bandwidth of Band 4 p.211	
Gain[dB]	Band4 Q	-18...+18	Sets the gain of Band 4	
Phaser				
P LFO [Hz]	LFO Freq [Hz]	0.02...20.00	Sets the speed of the LFO	
LFO	LFO Waveform	Tri (Triangle), Sine	Selects the LFO waveform	
P Depth	Phaser Depth	0...100	Sets the depth of LFO modulation	
Manual	←	0...100	Sets the frequency where the effect is applied	
Reso	Resonance	-100...+100	Sets the resonance amount p.225	
P Wet/Dry	[Phaser] Wet/Dry	-1:99, Dry, 1:99	Sets the phaser effect balance p.216, p.225	D ^{mod}
Src	[Phaser] Source	Off...Tempo	Selects the Wet/Dry modulation source for the phaser	
Amt	[Phaser] Amount	-100...+100	Sets the Wet/Dry modulation amount for the phaser	
P Out Mode	[Phaser] Output Mode	Normal, Wet Invert	Selects the phaser output mode p.252	
Wet/Dry	←	-Wet...-99 : 1, Dry, 99 : 1...Wet	Sets the balance between the effect and the dry input	D ^{mod}
Src	Source	Off...Tempo	Selects a modulation source for Wet/Dry	
Amt	Amount	-100...+100	Sets the modulation amount for Wet/Dry	

046: Comp - Wah (Compressor - Wah/Auto Wah)

This effect combines a mono compressor and a wah. You can change the order of the connection.

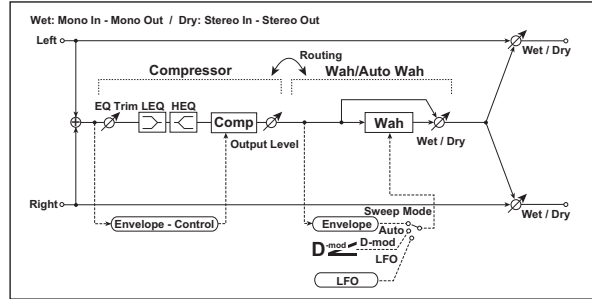

Parameter	Value	Explanation		
Compressor				
C Sens	Sensitivity	1...100	Sets the sensitivity p.207	
C Attack	Attack	1...100	Sets the attack level p.207	
Out Level	Leve	0...100	Sets the compressor output level p.207	
C EQ Trim	EQ Trim	0...100	Sets the EQ input level	
C LEQ [dB]	Low EQ Gain [dB]	-15...+15	Sets the gain of Low EQ	
HEQ [dB]	High EQ Gain [dB]	-15...+15	Sets the gain of High EQ	
Wah				
W Freq Btm	Frequency Bottom	0...100	Sets the lower limit of the wah center frequency p.213	
Freq Top	Frequency Top	0...100	Sets the upper limit of the wah center frequency p.213	
W Sweep	Sweep Mode	Auto, Dmod, LFO	Selects the control from auto-wah, modulation source, and LFO	
Src	Source	Off...Tempo	Selects the modulation source for the wah when Sweep Mode=Dmod	D ^{mod}
W LFO[Hz]	LFO Freq [Hz]	0.02...20.00	Sets the speed of the LFO	
Reso	Resonance	0...100	Sets the resonance amount	
LPF	←	Off, On	Switches the wah low pass filter on and off	
W Wet/Dry	[Wah] Wet/Dry	Dry, 1 : 99...99 : 1, Wet	Sets the wah effect balance	D ^{mod}
Src	[Wah]Source	Off...Tempo	Selects the Wet/Dry modulation source for the wah	
Amt	[Wah]Amount	-100...+100	Sets the Wet/Dry modulation amount for the wah	
Routing	←	Comp . Wah, Wah → Comp	Switches the order of the compressor and wah	
Wet/Dry	←	Dry, 1 : 99...99 : 1, Wet	Sets the balance between the effect and the dry input	D ^{mod}
Src	Source	Off...Tempo	Selects a modulation source for Wet/Dry	
Amt	Amount	-100...+100	Sets the modulation amount for Wet/Dry	

047: Comp - Amp Sim (Compressor - Amp Simulation)

This effect combines a mono compressor and an amp simulation. You can change the order of the effects.

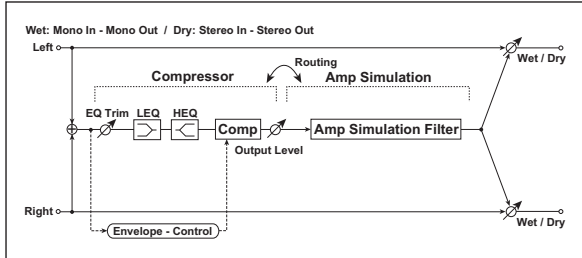

Parameter	Value	Explanation
Compressor		
C Sens	Sensitivity	1...100 Sets the sensitivity p.207
C Attack	Attack	1...100 Sets the attack level p.207
Out Level	Level	0...100 Sets the compressor output level p.207
C EQ Trim	EQ Trim	0...100 Sets the EQ input level
C LEQ [dB]	Low EQ Gain [dB]	-15...+15 Sets the gain of Low EQ
HEQ [dB]	High EQ Gain [dB]	-15...+15 Sets the gain of High EQ
Amp Simulation		
A Amp Type	Amp Type	SS, EL84, 6L6 Selects the type of guitar amplifier
Routing	←	Comp → Amp, Amp → Comp Switches the order of the compressor and amp simulation
Wet/Dry	←	Dry, 1 : 99... 99 : 1, Wet Sets the balance between the effect and the dry input
Src	Source	Off...Tempo Selects a modulation source for Wet/Dry
Amt	Amount	-100...+100 Sets the modulation amount for Wet/Dry

048: Comp - OD/HiGain (Compressor - Overdrive/HiGain)

This effect combines a mono compressor and an overdrive/high-gain distortion. You can change the order of the effects.

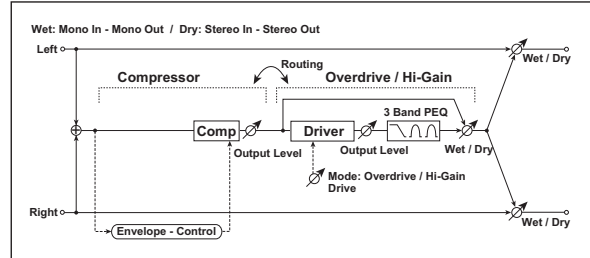

Parameter	Value	Explanation
Compressor		
C Sens	Sensitivity	1...100 Sets the sensitivity p.207
C Attack	Attack	1...100 Sets the attack level p.207
Out Level	Level	0...100 Sets the compressor output level p.207
Overdrive/Hi-Gain		
O Mode	Drive Mode	OverD (Overdrive), Hi-Gain Switches between overdrive and high-gain distortion
Drive	←	1...100 Sets the degree of distortion p.220
O Out Level	Level	0...50 Sets the overdrive output level p.220
Src	Source	Off...Tempo Selects the modulation source for the overdrive output level
Amt	Amount	-50...+50 Sets the modulation amount of the overdrive output level
O Low [Hz]	Low Cutoff [Hz]	20...1.00k Sets the center frequency for Low EQ (shelving type)
O Low [dB]	Low Gain [dB]	-18...+18 Sets the gain of Low EQ
O Mid1 [Hz]	Mid1 Cutoff [Hz]	300...10.00k Sets the center frequency for Mid/High EQ 1 (peaking type)
Q	Mid1 Q	0.5...10.0 Sets the band width of Mid/High EQ 1 p.211
Gain [dB]	Mid1 Gain [dB]	-18...+18 Sets the gain of Mid/High EQ 1
O Mid2 [Hz]	Mid2 Cutoff [Hz]	500...20.00k Sets the center frequency for Mid/High EQ 2 (peaking type)
Q	Mid2 Q	0.5...10.0 Sets the band width of Mid/High EQ 2 p.211
Gain [dB]	Mid2 Gain [dB]	-18...+18 Sets the gain of Mid/High EQ 2
O Wet/Dry	[OD/HG] Wet/Dry	Dry, 1 : 99...99 : 1, Wet Sets the overdrive effect balance
Src	[OD/HG] Source	Off...Tempo Selects the Wet/Dry modulation source for the overdrive
Amt	[OD/HG] Amount	-100...+100 Sets the Wet/Dry modulation amount for the overdrive
Route	Routing	Comp → OD/HG, OD/HG → Comp Switches the order of the compressor and overdrive
Wet/Dry	←	Dry, 1 : 99... 99 : 1, Wet Sets the balance between the effect and the dry input
Src	Source	Off...Tempo Selects a modulation source for Wet/Dry
Amt	Amount	-100...+100 Sets the modulation amount for Wet/Dry

049: Comp - P4EQ (Compressor - Parametric 4-Band EQ)

This effect combines a mono compressor and a four-band parametric equalizer. You can change the order of the effects.

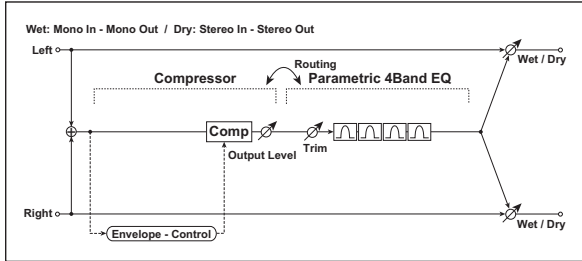

Parameter	Value	Explanation	
Compressor			
C Sens	Sensitivity	1...100	Sets the sensitivity p.207
C Attack	Attack	1...100	Sets the attack level p.207
Out Level	Level	0...100	Sets the compressor output level p.207
Parametric 4-Band EQ			
E Trim	Trim	0...100	Sets the parametric EQ input level
E B1 F[Hz]	Band1 Cutoff [Hz]	20...1.00k	Sets the center frequency of Band 1
Q	Band1 Q	0.5...10.0	Sets the bandwidth of Band 1 p.211
Gain[dB]	Band1 Gain [dB]	-18...+18	Sets the gain of Band 1
E B2 F[Hz]	Band2 Cutoff [Hz]	50...5.00k	Sets the center frequency of Band 2
Q	Band2 Q	0.5...10.0	Sets the bandwidth of Band 2 p.211
Gain[dB]	Band2 Gain [dB]	-18...+18	Sets the gain of Band 2
E B3 F[Hz]	Band3 Cutoff [Hz]	300...10.00k	Sets the center frequency of Band 3
Q	Band3 Q	0.5...10.0	Sets the bandwidth of Band 3 p.211
Gain[dB]	Band3 Gain [dB]	-18...+18	Sets the gain of Band 3
E B4 F[Hz]	Band4 Cutoff [Hz]	500...20.00k	Sets the center frequency of Band 4
Q	Band4 Q	0.5...10.0	Sets the bandwidth of Band 4 p.211
Gain[dB]	Band4 Gain [dB]	-18...+18	Sets the gain of Band 4
Routing	←	Comp → PEQ, PEQ → Comp	Switches the order of the compressor and parametric EQ
Wet/Dry	←	Dry, 1 : 99... 99 : 1, Wet	Sets the balance between the effect and the dry input
Src	Source	Off...Tempo	Selects a modulation source for Wet/Dry
Amt	Amount	-100...+100	Sets the modulation amount for Wet/Dry

050: Comp - Phaser (Compressor - Phaser)

This effect combines a mono compressor and a phaser. You can change the order of the effects.

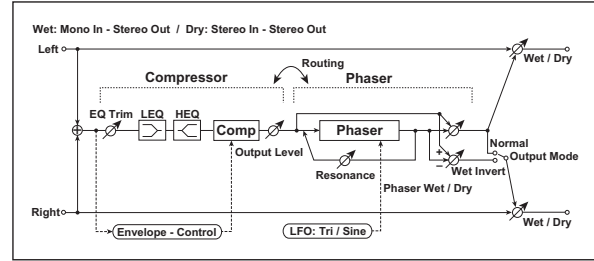

Parameter	Value	Explanation	
Compressor			
C Sens	Sensitivity	1...100	Sets the sensitivity p.207
C Attack	Attack	1...100	Sets the attack level p.207
Out Level	Level	0...100	Sets the compressor output level p.207
C EQ Trim	EQ Trim	0...100	Sets the EQ input level
C LEQ [dB]	Low EQ Gain [dB]	-15...+15	Sets the gain of Low EQ
HEQ [dB]	High EQ Gain [dB]	-15...+15	Sets the gain of High EQ
Phaser			
P LFO [Hz]	LFO Freq [Hz]	0.02...20.00	Sets the speed of the LFO
LFO	LFO Waveform	Tri (Triangle), Sine	Selects the LFO Waveform
P Depth	Depth	0...100	Sets the depth of LFO modulation
Manual	←	0...100	Sets the frequency where the effect is applied
Reso	Resonance	-100...+100	Sets the resonance amount p.225
P Wet/Dry	[Phaser] Wet/Dry	-Wet... -1 : 99, Dry, 1 : 99...Wet	Sets the phaser effect balance p.216, p.225
Src	[Phaser] Source	Off...Tempo	Selects the Wet/Dry modulation source for the phaser
Amt	[Phaser] Amount	-100...+100	Sets the Wet/Dry modulation amount for the phaser
P Out Mode	Output Mode	Normal, Wet Invert	Selects the phaser output mode p.243
Routing	←	Comp → Phaser, Phaser → Comp	Switches the order of the compressor and phaser p.252
Wet/Dry	←	-Wet... -99 : 1, Dry, 99 : 1...Wet	Sets the balance between the effect and the dry input
Src	Source	Off...Tempo	Selects a modulation source for Wet/Dry
Amt	Amount	-100...+100	Sets the modulation amount for Wet/Dry

051: Limiter - P4EQ (Limiter - Parametric 4-Band EQ)

This effect combines a mono limiter and a four-band parametric equalizer. You can change the order of the effects.

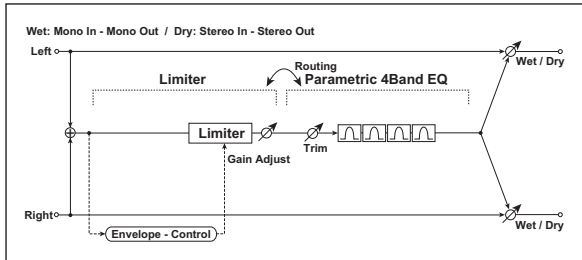

Parameter	Value	Explanation
Limiter		
L Ratio	Ratio	1.0 : 1... 50.0 : 1, Inf : 1 Sets the signal compression ratio p.208
Thresh[dB]	Threshold [dB]	-40...0 Sets the level above which the compressor is applied p.208
L Attack	Attack	1...100 Sets the attack time
Release	←	1...100 Sets the release time
L Gain [dB]	Gain Adjust [dB]	-Inf, -38...+24 Sets the limiter output gain p.208
Parametric 4-Band EQ		
E Trim	Trim	0...100 Sets the parametric EQ input level
E B1 F[Hz]	Band1 Cutoff [Hz]	20...1.00k Sets the center frequency of Band 1
Q	Band1 Q	0.5...10.0 Sets the bandwidth of Band 1 p.211
Gain [dB]	Band1 Gain [dB]	-18...+18 Sets the gain of Band 1
E B2 F[Hz]	Band2 Cutoff [Hz]	50...5.00k Sets the center frequency of Band 2
Q	Band2 Q	0.5...10.0 Sets the bandwidth of Band 2 p.211
Gain [dB]	Band2 Gain [dB]	-18...+18 Sets the gain of Band 2
E B3 F[Hz]	Band3 Cutoff [Hz]	300...10.00k Sets the center frequency of Band 3
Q	Band3 Q	0.5...10.0 Sets the bandwidth of Band 3 p.211
Gain [dB]	Band3 Gain [dB]	-18...+18 Sets the gain of Band 3
E B4 F[Hz]	Band4 Cutoff [Hz]	500...20.00k Sets the center frequency of Band 4
Q	Band4 Q	0.5...10.0 Sets the bandwidth of Band 4 p.211
Gain [dB]	Band4 Gain [dB]	-18...+18 Sets the gain of Band 4
Routing	←	Limiter → PEQ, PEQ → Limiter Switches the order of the limiter and parametric EQ
Wet/Dry	←	Dry, 1 : 99... 99 : 1, Wet Sets the balance between the effect and the dry input
Src	Source	Off...Tempo Selects a modulation source for Wet/Dry
Amt	Amount	-100...+100 Sets the modulation amount for Wet/Dry

052: Limiter - Phaser

This effect combines a mono limiter and a phaser. You can change the order of the effects.

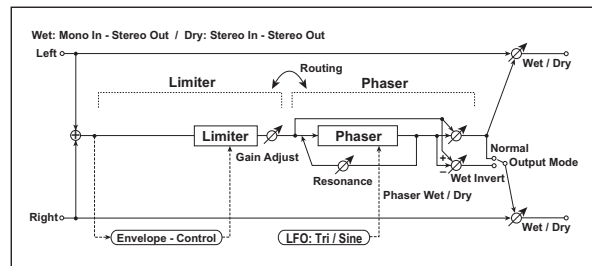

Parameter	Value	Explanation
Limiter		
L Ratio	Ratio	1.0 : 1... 50.0 : 1, Inf : 1 Sets the signal compression ratio p.208
Thresh[dB]	Threshold [dB]	-40...0 Sets the level above which the compressor is applied p.208
L Attack	Attack	1...100 Sets the attack time
Release	←	1...100 Sets the release time
L Gain [dB]	Gain Adjust [dB]	-Inf, -38...+24 Sets the limiter output gain p.208
Phaser		
P LFO [Hz]	LFO Freq [Hz]	0.02...20.00 Sets the speed of the LFO
LFO	LFO Waveform	Tri (Triangle), Sine Selects the LFO Waveform
Depth	←	0...100 Sets the depth of LFO modulation
Manual	←	0...100 Sets the frequency where the effect is applied
Reso	Resonance	-100...+100 Sets the resonance amount p.225
P Wet/Dry	[Phaser] Wet/Dry	-Wet... -1 : 99, Dry, 1 : 99...Wet Sets the phaser effect balance p.216, p.225
Src	[Phaser] Source	Off...Tempo Selects the phaser's Wet/Dry modulation source
Amt	[Phaser] Amount	-100...+100 Sets the phaser's Wet/Dry modulation amount
P Out	Output Mode	Normal, Wet Invert Selects the phaser output mode p.243
Routing	←	Limiter → Phaser, Phaser → Limiter Switches the order of the limiter and phaser p.252
Wet/Dry	←	-Wet... -99 : 1, Dry, 99 : 1...Wet Sets the balance between the effect and the dry input
Src	Source	Off...Tempo Selects a modulation source for Wet/Dry
Amt	Amount	-100...+100 Sets the modulation amount for Wet/Dry

053: Exciter - Comp (Exciter - Compressor)

This effect combines a mono exciter and a compressor. You can change the order of the effects.

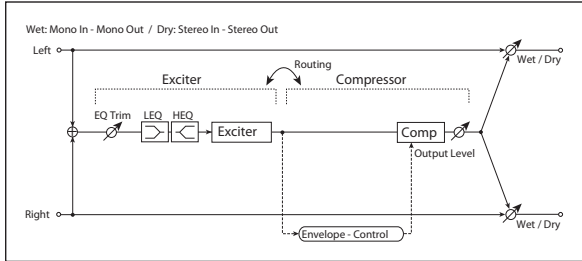

Parameter	Value	Explanation	
Exciter			
X Blend	Blend	-100...+100	Sets the intensity (depth) of the Exciter effect p.212
Frequency	Emphasis Frequency	0...70	Sets the frequency range to be emphasized p.212
X EQ Trim	Pre EQ Trim	0...100	Sets the EQ input level
X LEQ [dB]	Low EQ Gain [dB]	-15...+15	Sets the gain of Low EQ
HEQ [dB]	High EQ Gain [dB]	-15...+15	Sets the gain of High EQ
Compressor			
C Sens	Sensitivity	1...100	Sets the sensitivity p.207
C Attack	Attack	1...100	Sets the attack level p.207
OutLevel	←	0...100	Sets the compressor output level p.207
Routing	←	Exciter → Comp, Comp → Exciter	Switches the order of the exciter and compressor
Wet/Dry	←	Dry, 1 : 99... 99 : 1, Wet	Sets the balance between the effect and the dry input
Src	Source	Off...Tempo	Selects a modulation source for Wet/Dry
Amt	Amount	-100...+100	Sets the modulation amount for Wet/Dry

054: Exciter - Limiter

This effect combines a mono exciter and a limiter. You can change the order of the effects.

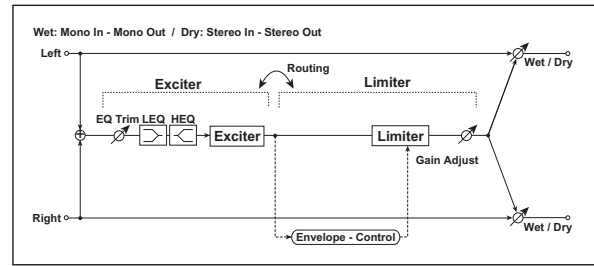

Parameter	Value	Explanation	
Exciter			
X Blend	Blend	-100...+100	Sets the intensity (depth) of the Exciter effect p.212
Frequency	Emphasis Freq	0...70	Sets the frequency range to be emphasized p.212
X EQ Trim	Pre EQ Trim	0...100	Sets the EQ input level
X LEQ [dB]	Low EQ Gain [dB]	-15...+15	Sets the gain of Low EQ
HEQ [dB]	High EQ Gain [dB]	-15...+15	Sets the gain of High EQ
Limiter			
L Ratio	Ratio	1.0 : 1... 50.0 : 1, Inf : 1	Sets the signal compression ratio p.208
Thrsh[dB]	Threshold [dB]	-40...0	Sets the level above which the compressor is applied p.208
L Attack	Attack	1...100	Sets the attack time
Release	Release	1...100	Sets the release time
L Gain [dB]	Gain Adjust [dB]	-Inf, -38...+24	Sets the limiter output gain p.208
Routing	←	Exciter → Limiter, Limiter → Exciter	Switches the order of the exciter and limiter
Wet/Dry	←	Dry, 1 : 99... 99 : 1, Wet	Sets the balance between the effect and the dry input
Src	Source	Off...Tempo	Selects a modulation source for Wet/Dry
Amt	Amount	-100...+100	Sets the modulation amount for Wet/Dry

055: Exciter - Phaser

This effect combines a mono limiter and a phaser.

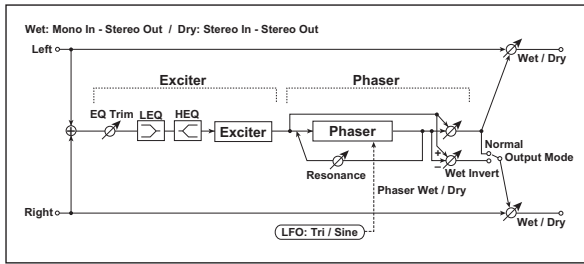

Parameter	Value	Explanation
Exciter		
X Blend	Blend	-100...+100
Frequency	Emphasis Frequency	0...70
X EQ Trim	Pre EQ Trim	0...100
X LEQ [dB]	Low EQ Gain [dB]	-15...+15
HEQ [dB]	High EQ Gain [dB]	-15...+15
Phaser		
P LFO [Hz]	LFO Freq [Hz]	0.02...20.00
LFO	LFO Waveform	Tri (Triangle), Sine
P Depth	Depth	0...100
Manual	←	0...100
Reso	Resonance	-100...+100
P Wet/Dry	[Phaser] Wet/Dry	-Wet...-1 : 99, Dry, 1 : 99...Wet
Src	[Phaser] Source	Off...Tempo
Amt	[Phaser] Amount	-100...+100
P Out Mode	Output Mode	Normal, Wet Invert
Wet/Dry	←	-Wet...-99 : 1, Dry, 99 : 1...Wet
Src	Source	Off...Tempo
Amt	Amount	-100...+100

056: OD/HG - Amp Sim (Overdrive/Hi.Gain - Amp Simulation)

This effect combines a mono overdrive/high-gain distortion and an amp simulation. You can change the order of the effects.

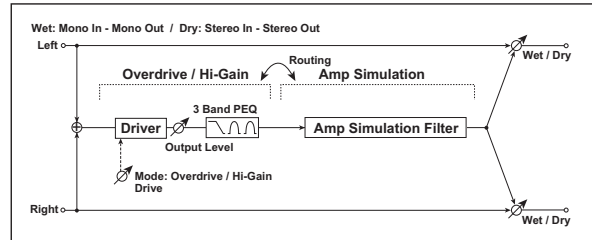

Parameter	Value	Explanation
Overdrive/Hi-Gain		
O Mode	Drive Mode	OverD (Overdrive), Hi-Gain
Drive		1...100
O Out Level		0...50
Src	Source	Off...Tempo
Amt	Amount	-50...+50
O Low [Hz]	Low Cutoff [Hz]	20...1.00k
Gain[dB]	Low Gain [dB]	-18...+18
Q	Mid1 Q	0.5...10.0
Gain[dB]	Mid1 Gain [dB]	-18...+18
O Mid1 [Hz]	Mid1 Cutoff [Hz]	300...10.0k
Q	Mid1 Q	0.5...10.0
Gain[dB]	Mid1 Gain [dB]	-18...+18
O Mid2 [Hz]	Mid2 Cutoff [Hz]	500...20.00k
Q	Mid2 Q	0.5...10.0
Gain[dB]	Mid2 Gain [dB]	-18...+18
Amp Simulation		
A Amp Type	Amp Type	SS, EL84, 6L6
Routing	←	OD → Amp, Amp → OD
Wet/Dry	←	Dry, 1 : 99... 99 : 1, Wet
Src	Source	Off...Tempo
Amt	Amount	-100...+100

057: OD/HG - Phaser (Overdrive/Hi.Gain - Phaser)

This effect combines a mono overdrive/high-gain distortion and a phaser. You can change the order of the effects.

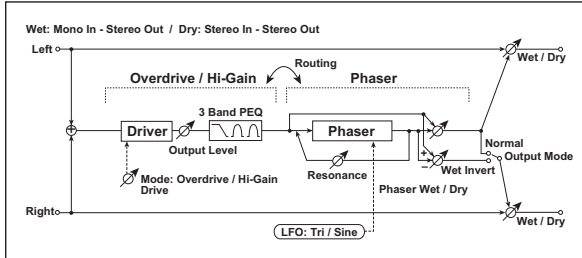

Parameter	Value	Explanation	
Overdrive/Hi-Gain			
O Mode	Drive Mode	OverD (Overdrive), Hi-Gain	Switches between overdrive and high-gain distortion
Drive	←	1...100	Sets the degree of distortion p.220
O Out Level	Level	0...50	Sets the overdrive output level p.220
Src	Source	Off...Tempo	Selects the modulation source for the overdrive output level
Amt	Amount	-50...+50	Sets the modulation amount of the overdrive output level
O Low [Hz]	Low Cutoff [Hz]	20...1.00k	Sets the center frequency for Low EQ (shelving type)
Gain[dB]	Low Gain [dB]	-18...+18	Sets the gain of Low EQ
O Mid1[Hz]	Mid1 Cutoff [Hz]	300...10.00k	Sets the center frequency for Mid/High EQ 1 (peaking type)
Q	Mid1 Q	0.5...10.0	Sets the band width of Mid/High EQ 1 p.211
Gain[dB]	Mid1 Gain [dB]	-18...+18	Sets the gain of Mid/High EQ 1
O Mid2[Hz]	Mid2 Cutoff [Hz]	500...20.00k	Sets the center frequency for Mid/High EQ 2 (peaking type)
Q	Mid2 Q	0.5...10.0	Sets the band width of Mid/High EQ 2 p.211
Gain[dB]	Mid2 Gain [dB]	-18...+18	Sets the gain of Mid/High EQ 2
Phaser			
P LFO [Hz]	LFO Freq [Hz]	0.02...20.00	Sets the speed of the LFO
LFO	LFO Waveform	Tri (Triangle), Sine	Selects the LFO Waveform
P Depth	Depth	0...100	Sets the depth of LFO modulation
Manual	←	0...100	Sets the frequency where the effect is applied
P Reso	Resonance	-100...+100	Sets the resonance amount p.225
P Out	Output Mode	Normal, Wet Invert	Selects the phaser output mode p.252
P W/D	[Phs] Wet/Dry	-Wet...-1 : 99, Dry, 1 : 99...Wet	Sets the phaser effect balance p.216, p.225
Src	[Phs] Source	Off...Tempo	Selects the Wet/Dry modulation source for the phaser
Amt	[Phs] Amount	-100...+100	Sets the Wet/Dry modulation amount for the phaser
Routing	←	OD/HG → Phaser, Phaser → OD/HG	Switches the order of the overdrive and phaser p.252

Wet/Dry	←	-Wet...-99 : 1, Dry, 99 : 1...Wet	Sets the balance between the effect and the dry input	D-mod
Src	Source	Off...Tempo	Selects a modulation source for Wet/Dry	
Amt	Amount	-100...+100	Sets the modulation amount for Wet/Dry	

058: Wah - Amp Sim (Wah - Amp Simulation)

This effect combines a mono wah and an amp simulation. You can change the order of the effects.

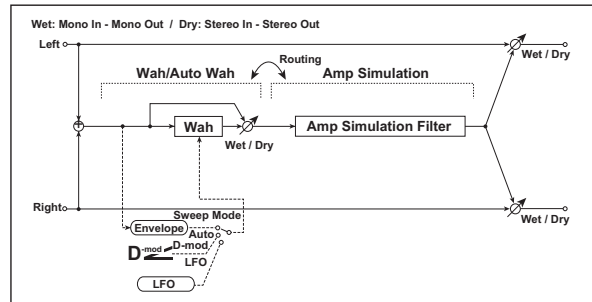

Parameter	Value	Explanation	
Wah/Auto Wah			
W Freq Btm	Frequency Bottom	0...100	Sets the lower limit of the wah center frequency p.213
Freq Top	Frequency Top	0...100	Sets the upper limit of the wah center frequency p.213
W Sweep	Sweep Mode	Auto, Dmod, LFO	Selects the control from auto-wah, modulation source, and LFO p.213
Src	Source	Off...Tempo	Selects the modulation source for the wah when Sweep Mode=Dmod
W LFO[Hz]	LFO Freq [Hz]	0.02...20.00	Sets the speed of the LFO
Reso	Resonance	0...100	Sets the resonance amount
LPF	←	Off, On	Switches the wah low pass filter on and off
W Wet/Dry	[Wah] Wet/Dry	Dry, 1 : 99... 99 : 1, Wet	Sets the wah effect balance
Src	[Wah]Source	Off...Tempo	Selects the Wet/Dry modulation source for the wah
Amt	[Wah]Amount	-100...+100	Sets the Wet/Dry modulation amount for the wah
Amp Simulation			
A Amp Type	Amp Type	SS, EL84, 6L6	Selects the type of guitar amplifier
Routing	←	Wah → Amp, Amp → Wah	Switches the order of the wah and amp simulation
Wet/Dry	←	Dry, 1 : 99... 99 : 1, Wet	Sets the balance between the effect and the dry input
Src	Source	Off...Tempo	Selects a modulation source for Wet/Dry
Amt	Amount	-100...+100	Sets the modulation amount for Wet/Dry

059: Decimator - Amp (Decimator - Amp Simulation)

This effect combines a mono decimator and an amp simulation. You can change the order of the effects.

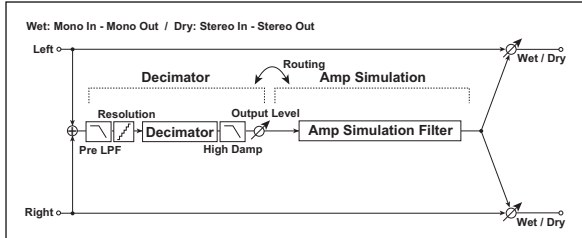

Parameter	Value	Explanation
Decimator		
D Pre LPF	Pre LPF	Off, On Turn the harmonic noise caused by lowered sampling on and off p.219
HiDamp [%]	High Damp [%]	0...100 Sets the ratio of high-range damping
D Fs[Hz]	Sampling Freq [Hz]	1.00k...48.00 k Sets the sampling frequency
Bit Reso	Resolution [bit]	4...24 Sets the data bit length p.219
D OutLevel	Level	0...100 Sets the decimator output level p.219
Amp Simulation		
A Amp Type	Amp Type	SS, EL84, 6L6 Selects the type of guitar amplifier
Routing	←	Decimator → Amp, Amp → Decimator Switches the order of the decimator and amp simulation
Wet/Dry	←	Dry, 1 : 99... 99 : 1, Wet Sets the balance between the effect and the dry input D²ad
Src	Source	Off...Tempo Selects a modulation source for Wet/Dry
Amt	Amount	-100...+100 Sets the modulation amount for Wet/Dry

060: Decimator - Comp (Decimator - Compressor)

This effect combines a mono decimator and a compressor. You can change the order of the effects.

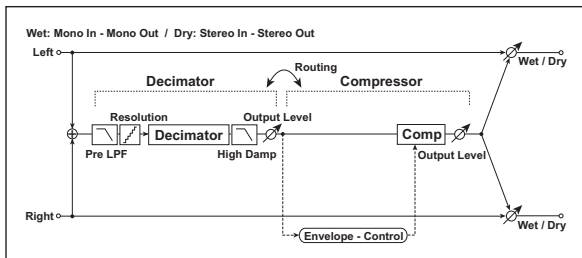

Parameter	Value	Explanation
Decimator		
P Pre LPF	Pre LPF	Off, On Turn the harmonic noise caused by lowered sampling on and off p.219
HiDamp [%]	High Damp [%]	0...100 Sets the ratio of high-range damping
D Fs[Hz]	Sampling Freq [Hz]	1.00k...48.00 k Sets the sampling frequency
Bit Reso	Resolution	4...24 Sets the data bit length p.219
D OutLevel	Level	0...100 Sets the decimator output level p.219

Parameter	Value	Explanation
C Sens	Sensitivity	1...100 Sets the sensitivity p.207
C Attack	Attack	1...100 Sets the attack level p.207
Out Level	Level	0...100 Sets the compressor output level p.207
Routing	←	Dec → Cmp, Cmp → Dec Switches the order of the decimator and compressor
Wet/Dry	←	Dry, 1 : 99... 99 : 1, Wet Sets the balance between the effect and the dry input D²ad
Src	Source	Off...Tempo Selects a modulation source for Wet/Dry
Amt	Amount	-100...+100 Sets the modulation amount for Wet/Dry

061: AmpSim - Tremolo (Amp Simulation- Tremolo)

This effect combines a mono amp simulation and a tremolo.

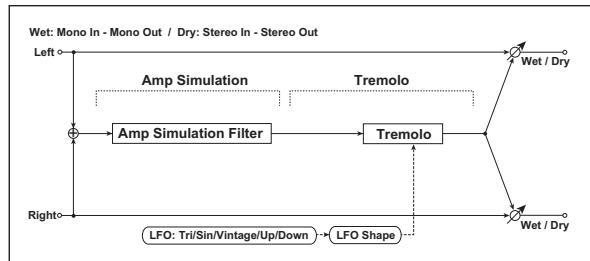

Parameter	Value	Explanation
Amp Simulation		
A Amp Type	Amp Type	SS, EL84, 6L6 Selects the type of guitar amplifier
Tremolo		
T LFO Wave	LFO Waveform	Tri (Triangle), Sine, Vntage (Vintage), Up, Down Selects the LFO Waveform p.228
LFO Shape	←	-100...+100 Changes the curvature of the LFO Waveform p.214
T LFO[Hz]	LFO Freq [Hz]	0.02...20.00 Sets the speed of the LFO
Depth	←	0...100 Sets the depth of LFO modulation
Wet/Dry	←	Dry, 1 : 99... 99 : 1, Wet Sets the balance between the effect and the dry input D²ad
Src	Source	Off...Tempo Selects a modulation source for Wet/Dry
Amt	Amount	-100...+100 Sets the modulation amount for Wet/Dry

062: Organ Vib/Chorus (Organ Vibrato/Chorus)

This effect simulates the chorus and vibrato circuitry of a vintage organ. The modulation speed and depth can be customized.

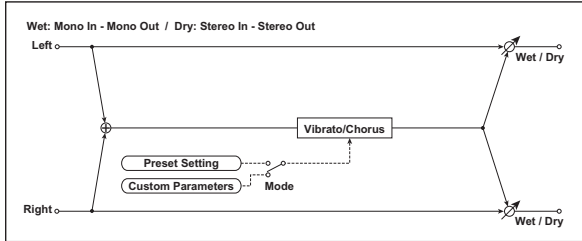

Paramter	Value	Explanation	
Mode	Control Mode	Preset, Cstm (Custom)	Selects either preset or custom settings p.241
Input Trim	←	0...100	Sets the input level
Preset	Preset Type	V1, C1, V2, C2, V3, C3	Selects the effect type when Mode=Preset V1/V2/V3 are variations of vibrato, and C1/C2/C3 are variations of chorus p.241
Src	Source	Off...Tempo	Selects the modulation source that will change the effect type
Amt	Amount	-5...+5	Sets the modulation amount for changing the effect type p.241
Cstm Mix	Custom Mix	Vibrato, 1:99...99:1, Chorus	Sets the mix level of the direct sound when Mode=Preset p.241
Src	Source	Off...Tempo	Selects the modulation source that will control the mix level of the direct sound
Amt	Amount	-100...+100	Sets the modulation amount for controlling the mix level of the direct sound
Cstm Dep	Custom Depth	0...100	Sets the vibrato depth p.241
Src	Source	Off...Tempo	Selects the modulation source that will control vibrato depth
Amt	Amount	-100...+100	Sets the modulation amount for controlling the vibrato depth
Cstm Spd	Custom Speed[Hz]	0.02...20.00	Sets the vibrato speed p.241
Src	Source	Off...Tempo	Selects the modulation source for controlling the vibrato speed
Amt	Amount	-20.00...+20.00	Sets the modulation amount for controlling the vibrato speed
Wet/Dry	←	Dry, 1 : 99... 99 : 1, Wet	Sets the balance between the effect and the dry input
Src	Source	Off...Tempo	Selects a modulation source for Wet/Dry
Amt	Amount	-100...+100	Sets the modulation amount for Wet/Dry

- Control Mode
- Preset Type
- Custom Mix
- Custom Depth
- Custom Speed

If **Control Mode**=Preset, you can use **Preset Type** to select the effect. In this case, the **Custom Mix/Depth/Speed** settings are ignored. If **Control Mode**=Custom, the **Custom Mix/Depth/Speed** settings are valid, and the **Preset Type** setting is ignored.

Amount

If **Preset Type**=V1 and **Source**=M.Whl #1, setting this to +5 and moving the modulation wheel away from yourself will control the setting in the order of V1→C1→V2→C2→V3→C3.

063: Rotary Speaker

This effect simulates a rotary speaker, and obtains a more realistic sound by simulating the rotor in the low range and the horn in the high range separately. The effect also simulates the stereo microphone settings.

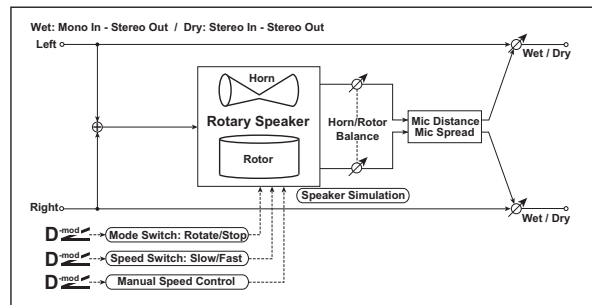

Paramter	Value	Explanation	
Mode SW	Mode	Rotate, Stop	Switches between speaker rotation and stop
Src	Source	Off...Tempo	Selects a modulation source for Rotate/ Stop
Sw	Switch Mode	Toggle, Moment	Sets the switch mode for Rotate/Stop modulation p.242
Speed Sw	Speed Switch	Slow, Fast	Switches the speaker rotation speed between slow and fast p.242
Src	Source	Off...Tempo	Selects a modulation source for Slow/Fast
Sw	Switch Mode	Toggle, Moment	Sets the switch mode for Slow/Fast modulation p.242
H/R Bal	H/R Balance	Rotor, 1...99, Horn	Sets the level balance between the high-frequency horn and low-frequency rotor
Manu Spd Ctl	Manual Speed	Off...Tempo	Sets a modulation source for direct control of rotation speed p.242
Horn Accel	Horn Acceleration	0...100	How quickly the horn rotation speed in the high range is switched p.242
Horn Ratio	←	Stop, 0.50...2.00	Adjusts the (high-range side) horn rotation speed. Standard value is 1.00. Selecting "Stop" will stop the rotation
Rotor Accel	Rotor Acceleration	0...100	Determines how quickly the rotor rotation speed in the low range is switched p.242

RotorRatio	←	Stop, 0.50...2.00	Adjusts the (low-frequency) rotor speed. Standard value is 1.00. Selecting "Stop" will stop the rotation	
MicDistnce	Mic Distance	0...100	Sets the distance between the microphone and rotary speaker p.242	
Mic Spread	←	0...100	Sets the angle of left and right microphones p.242	
Wet/Dry	←	Dry, 1:99...99:1, Wet	Sets the balance between the effect and the dry input	
Src	Source	Off...Tempo	Selects a modulation source for Wet/Dry	
Amt	Amount	-100...+100	Sets the modulation amount for Wet/Dry	

Mode

This parameter sets how the modulation source switches between rotation and stop.
 When "Mode" = **Toggle**, the speaker rotates or stops alternately each time you press the pedal or move the modulation wheel. Via MIDI, rotation will switch between start and stop each time the modulation amount exceeds 64.
 When "Mode" = **Moment**, the speaker rotates by default, and stops only when you press the pedal or move the modulation wheel. Via MIDI, modulation values above 64 make the speaker rotate, and values below 64 make it stop.

Speed Switch

This parameter controls how the rotation speed (slow and fast) is switched via the modulation source.
 When "SMode" = **Toggle**, the speed will switch between slow and fast each time you press the pedal or move the modulation wheel. Via MIDI, the speed will switch each time the modulation amount exceeds 64.
 When "Mode" = **Moment**, the speed is usually slow. It becomes fast only when you press the pedal or move the modulation wheel. Via MIDI, modulation values above 64 set the speed to **Fast**, and values below 64 set it to **Slow**.

Manual Speed

If you wish to control the rotation speed manually, instead of switching between Slow and Fast, select a modulation source in the "Manual Speed" parameter. If you don't want to use manual control, set this to **Off**.

Horn Acceleration
Rotor Acceleration

On a real rotary speaker, the rotation speed accelerates or decelerates gradually after you switch the speed. The "Horn" and "Rotor Acceleration" parameters set the transition times between fast and slow speeds.

Mic Distance
Mic Spread

This is a simulation of stereo microphone settings.

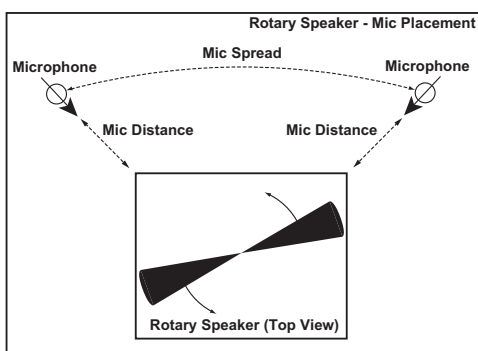

Effects 064–120 can be selected only for the master effect. The master effect does not output a Dry (direct) sound; only the Wet (effect) sound is output, and then mixed with the Dry (direct) sound in the L/R bus.

The parameter names and effect block diagrams are shown in the same way as for the other effects that can also be used as an insert effect, but please note the following points.

- "Wet/Dry" parameter: This controls the level of the Wet (effect) sound. The Dry (direct) sound is not output.
- The output for the Dry (direct) sound is not shown in the effect block diagram.

("In/Out" on page 200)

064: Stereo Chorus

This effect adds thickness and warmth to the sound by modulating the delay time of the input signal. You can add spread to the sound by offsetting the phase of the left and right LFOs from each other.

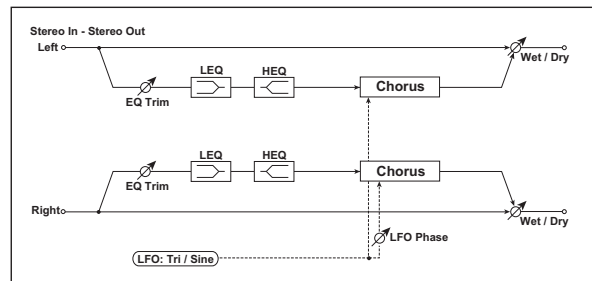

Parmer	Value	Explanation	
LFO	LFO Waveform	Tri (Triangle), Sine	Selects the LFO Waveform
LFO Phase [deg]	←	-180...+180	Sets the LFO phase difference between the left and right p.216
LFO [Hz]	LFO Freq [Hz]	0.02...20.00	Sets the speed of the LFO p.216
Src	Source	Off...Tempo	Selects a modulation source for LFO speed
Amt	Amount	-20.00...+20.00	Sets the modulation amount of LFO speed
MIDI Sync	BPM/MIDI Sync	Off, On	When this is on, the LFO speed is set by BPM, Base Note, and Times, instead of Frequency p.213
BPM	←	MIDI, 40.00...300.00	MIDI syncs to the system tempo; 40–300 sets the tempo manually for this individual effect p.213
Base Note	←		Selects the type of notes that specify the LFO speed p.213
Times	←	x1...x32	Sets the number of notes that specify the LFO speed p.213
Depth	←	0...100	Sets the depth of LFO modulation
L Dly[ms]	L Pre Delay [ms]	0.0...50.0	Sets the delay time for the left channel p.243
R Dly[ms]	R Pre Delay [ms]	0.0...50.0	Sets the delay time for the right channel p.243
PreEQ Trim	Pre EQ Trim	0...100	Sets the EQ input level
Pre LEQ Fc	Low EQ Frequency	Low, Mid-Low	Selects the cutoff frequency (low or mid-low) of the low-range equalizer
Pre HEQ Fc	High EQ Frequency	High, Mid-Hi	Selects the cutoff frequency (high or mid-high) of the high-range equalizer

LEQ [dB]	Low EQ Gain [dB]	-15.0...+15.0	Sets the gain of the Low EQ	
HEQ [dB]	High EQ Gain [dB]	-15.0...+15.0	Sets the gain of the High EQ	
Wet/Dry	←	-Wet... -99 : 1, Dry, 99 : 1...Wet	Sets the balance between the effect and the dry input p.216	D ^{mod}
Src	Source	Off...Tempo	Selects a modulation source for Wet/Dry	
Amt	Amount	-100...+100	Sets the modulation amount for Wet/Dry	

L Pre Delay [ms]

R Pre Delay [ms]

Setting the left and right delay time individually allows you to control the stereo image.

065: Vintage Chorus

This models a famous chorus unit that was built into a guitar amp. Although it does not provide a chorus and vibrato select switch, you can use the “Wet/Dry” and “Bus” settings to produce their effect. The “Speed,” “Depth,” and “Manual” parameters allow an even wider range of sounds than the original unit.

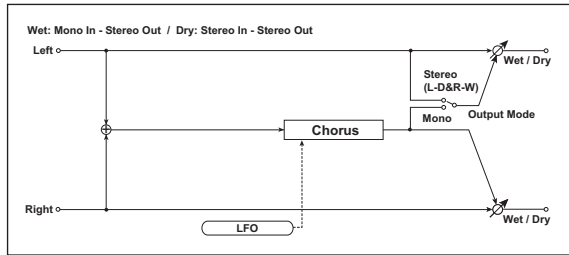

Paramter	Value	Explanation	
Speed [Hz]	←	0.10...10.0	Sets the speed of LFO
Depth	←	0...100	Sets the modulation depth
Manual	←	1...100	Sets the sweep frequency
Out Mode	Output Mode	0, 1	Sets the output mode 0: Mono 1: ST (L-D& R-W)
Wet/Dry	←	Dry, 1:99 ... 99:1, Wet	Sets the balance between the effect and the dry input D ^{mod}
Src	Source	Off...Tempo	Selects a modulation source for Wet/Dry
Amt	Amount	-100 ... +100	Sets the modulation amount for Wet/Dry

Wet/Dry

Output Mode

For the master effects, “Wet/Dry” adjusts the output level of the effect sound.

When “Output Mode” is Mono, L and R will output the same vibrato effect. Normally, you’ll produce a chorus effect by adjusting the return level to mix the processed sound with the direct sound. If you turn “Bus” Off and adjust the settings so that none of the direct sound is mixed in, a vibrato effect will be produced.

If “Output Mode” is Stereo (L-Dry & R-Wet), the direct sound will be panned to L, and the effect sound will be panned to R for output. Normally, you’ll mix the direct sound and effect sound by adjusting the return level, applying chorus only to the R channel, and producing a stereo effect that’s spread to the left and right. If you turn “Bus” Off, pan the direct sound and effect sound to the left and right, and output them from stereo speakers, the effect sound and direct sound will be panned in stereo, producing a clear and spacious chorus effect.

066: Black Chorus

This models a Danish-made stereo chorus + pitch modulator & flanger. Although this effect was originally intended for guitar, it was also used by numerous keyboard players. Used with electric piano, it produces a distinctive tone.

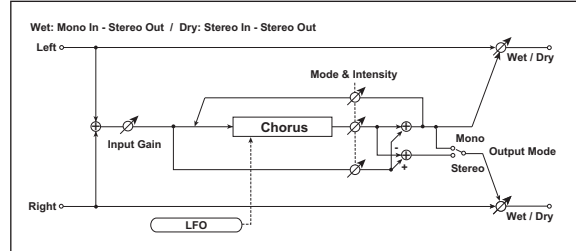

Paramter	Value	Explanation	
Speed [Hz]	←	0.10...10.0	Sets the LFO speed
Width	←	0...2	Sets the LFO modulation depth
Mode	←	Chorus Pitch Mod Flanger	Select a mode
Intensity	←	1...100	Sets the intensity of LFO modulation
Input Gain	←	1...1000	Sets the input gain
Out Mode	Output Mode	0, 1	Select a output mode 0: Mono 1: Stereo
Wet/Dry	←	Dry, 1:99 ... 99:1, Wet	Sets the balance between the effect and the dry input D ^{mod}
Src	Source	Off...Tempo	Selects a modulation source for Wet/Dry
Amt	Amount	-100 ... +100	Sets the modulation amount for Wet/Dry

Mode

Intensity

Increasing the “Intensity” value will strengthen the modulation effect. This controls the effect, direct, and feedback values. The values that are controlled will depend on the “Mode” setting.

067: St.HarmonicChorus (Stereo Harmonic Chorus)

This effect applies chorus only to the higher frequencies. This can be used to apply a chorus effect to a bass sound without making the sound thinner. You can also use this chorus block with feedback as a flanger.

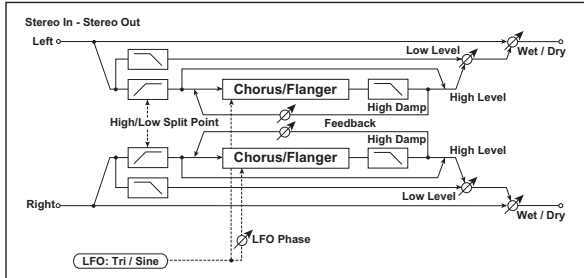

Paramter	Value	Explanation
LFO	LFO Waveform Tri (Triangle), Sine	Selects the LFO Waveform
LFO Phase [deg]	← -180...+180	Sets the LFO phase difference between the left and right p.216
LFO [Hz]	LFO Freq [Hz] 0.02...20.00	Sets the speed of the LFO p.216
Src	Source Off...Tempo	Selects a modulation source for LFO speed
Amt	Amount -20.00...+20.00	Sets the modulation amount of LFO speed
MIDI Sync	BPM/MIDI Sync Off, On	When this is on, the LFO speed is set by BPM, Base Note, and Times, instead of Frequency p.213
BPM	← MIDI, 40.00...300.00	MIDI syncs to the system tempo; 40-300 sets the tempo manually for this individual effect p.213
Base Note	←	Selects the type of notes that specify the LFO speed p.213
Times	← x1...x32	Sets the number of notes that specify the LFO speed p.213
Depth	← 0...100	Sets the depth of LFO modulation
Delay[ms]	Pre Delay [ms] 0.0...50.0	Sets the delay time from the original sound
Feedback	← -100...+100	Sets the feed back amount of the chorus block p.244
HiDamp [%]	High Damp [%] 0...100	Sets the high range damping amount of the chorus block
Hi/Lo Split	High/Low Split 1...100	Sets the frequency split point between the low and high range p.244
Low Level	← 0...100	Sets the low range output level
High Level	← 0...100	Sets the high range (chorus) output level
Wet/Dry	← Dry, 1 : 99... 99 : 1, Wet	Sets the balance between the effect and the dry input p.216
Src	Source Off...Tempo	Selects a modulation source for Wet/Dry
Amt	Amount -100...+100	Sets the modulation amount for Wet/Dry

High/Low Split

This parameter sets the frequency that splits the high and low range. Only the high range will be sent to the chorus block.

Feedback

Sets the feedback amount of the chorus block. Increasing the feedback will allow you to use the effect as a flanger.

068: St. Biphase Mod. (Stereo Biphase Modulation)

This stereo chorus effect adds two different LFOs together. You can set the Frequency and Depth parameters for each LFO individually. Depending on the setting of these LFOs, very complex waveforms will create an analog-type, unstable modulated sound.

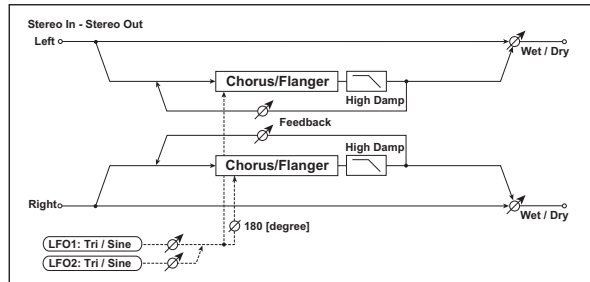

Paramter	Value	Explanation
LFO1	LFO1 Waveform Tri (Triangle), Sine	Selects LFO1 waveform
LFO2	LFO2 Waveform Tri (Triangle), Sine	Selects LFO2 waveform
Phase	Phase Sw 0, 180(deg)	Switches the LFO phase difference between left and right
LFO1[Hz]	LFO1 Freq [Hz] 0.02...30.00	Sets the LFO1 speed p.216
Src	Source Off...Tempo	Selects the modulation source of LFO1&2 speed
Amt	Amount -30.00...+30.00	Sets the modulation amount of LFO1 speed
LFO2[Hz]	LFO2 Freq [Hz] 0.02...30.00	Sets the LFO2 speed p.216
Amt	Amount -30.00...+30.00	Sets the modulation amount of LFO2 speed
Depth1	← 0...100	Sets the depth of LFO1 modulation
Depth2	← 0...100	Sets the depth of LFO2 modulation
L Dly[ms]	L Pre Delay [ms] 0.0...50.0	Sets the delay time for the left channel p.243
R Dly[ms]	R Pre Delay [ms] 0.0...50.0	Sets the delay time for the right channel p.243
Feedback	← -100...+100	Sets the feedback amount p.244
HiDamp [%]	High Damp [%] 0...100	Sets the damping amount in the high range
Wet/Dry	← -Wet... -99 : 1, Dry, 99 : 1...Wet	Sets the balance between the effect and the dry input p.216
Src	Source Off...Tempo	Selects a modulation source for Wet/Dry
Amt	Amount -100...+100	Sets the modulation amount for Wet/Dry

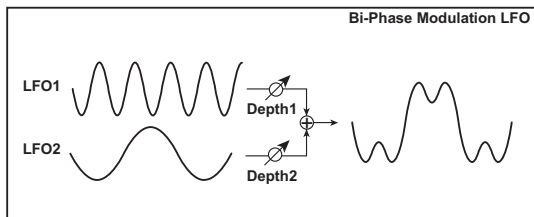

069: Multitap Cho/Delay (Multitap Chorus/Delay)

This effect has four chorus blocks with a different LFO phase. You can create a complex stereo image by setting each block's delay time, depth, output level, and pan individually. You can also fix some of the chorus blocks to combine the chorus and delay effects.

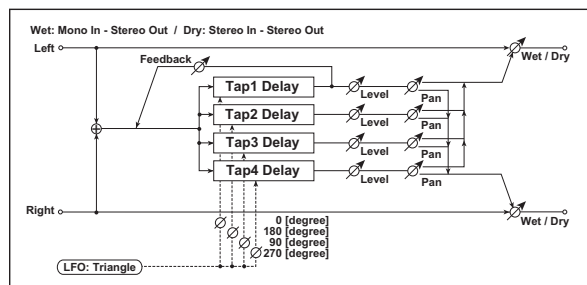

Paramter	Value	Explanation	
Tap1 [ms]	Tap1 Delay (000) [ms]	0...110	Sets the Tap1 (LFO phase=0 degrees) delay time
Dep	Tap1 Depth	0...30	Sets the Tap1 chorus depth
Lvl	Tap1 Level	0...30	Sets the Tap1 output level
Pan	Tap1 Pan	L6...L1, C, R1...R6	Sets the Tap1 stereo image
Tap2 [ms]	Tap2 Delay (180) [ms]	0...110	Sets the Tap2 (LFO phase=180 degrees) delay time
Dep	Tap2 Depth	0...30	Sets the Tap2 chorus depth
Lvl	Tap2 Level	0...30	Sets the Tap2 output level
Pan	Tap2 Pan	L6...L1, C, R1...R6	Sets the Tap2 stereo image
Tap3 [ms]	Tap3 Delay (090) [ms]	0...110	Sets the Tap3 (LFO phase=90 degrees) delay time
Dep	Tap3 Depth	0...30	Sets the Tap3 chorus depth
Lvl	Tap3 Level	0...30	Sets the Tap3 output level
Pan	Tap3 Pan	L6...L1, C, R1...R6	Sets the Tap3 stereo image
Tap4 [ms]	Tap4 Delay (270) [ms]	0...110	Sets the Tap4 (LFO phase=270 degrees) delay time
Dep	Tap4 Depth	0...30	Sets the Tap4 chorus depth
Lvl	Tap4 Level	0...30	Sets the Tap4 output level
Pan	Tap4 Pan	L6...L1, C, R1...R6	Sets the Tap4 stereo image
LFO [Hz]	LFO Freq [Hz]	0.02...13.00	Sets the speed of the LFO
Tap1 FB	Tap1 Feedback	-100...+100	Sets the Tap1 feedback amount
Src	Source	Off...Tempo	Selects the modulation source of Tap1 feedback amount and effect balance
Amt	Amount	-100...+100	Sets the Tap1 feedback amount and modulation amount

Wet/Dry	←	Dry, 1 : 99... 99 : 1, Wet	Sets the balance between the effect and the dry input	D^{mod}
Src	Source	Off...Tempo	Selects a modulation source for Wet/Dry	
Amt	Amount	-100...+100	Sets the modulation amount for Wet/Dry	

070: Ensemble

This Ensemble effect has three chorus blocks that use LFO to create subtle shimmering, and gives three dimensional depth and spread to the sound, because the signal is output from the left, right, and center.

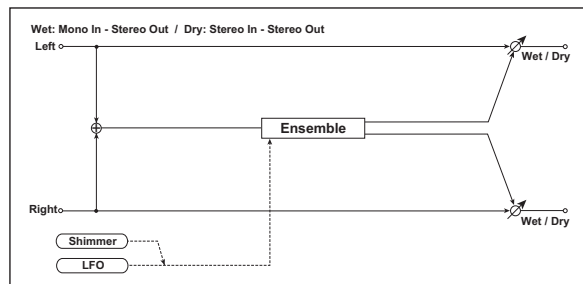

Parameter	Value	Explanation	
Speed	←	1...100	Sets the speed of the LFO
Src	Source	Off...Tempo	Selects a modulation source for LFO speed
Amt	Amount	-100...+100	Sets the modulation amount of LFO speed
Depth	←	0...100	Sets the depth of LFO modulation
Src	Source	Off...Tempo	Selects the modulation source of the LFO modulation depth
Amt	Amount	-100...+100	Sets the modulation amount of the LFO modulation depth
Shimmer	←	0...100	Sets the amount of shimmering of the LFO waveform p.245
Wet/Dry	←	-Wet... -99 : 1, Dry, 99 : 1...Wet	Sets the balance between the effect and the dry input
Src	Source	Off...Tempo	Selects a modulation source for Wet/Dry
Amt	Amount	-100...+100	Sets the modulation amount for Wet/Dry

Shimmer

This parameter sets the amount of shimmering of the LFO waveform. Increasing this value adds more shimmering, making the chorus effect more complex and richer.

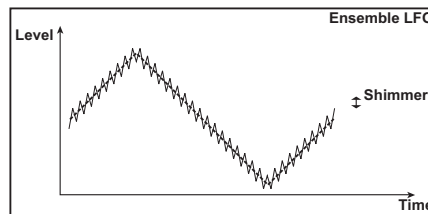

071: Polysix Ensemble

This models the ensemble effect built into the classic Korg PolySix programmable polyphonic synthesizer.

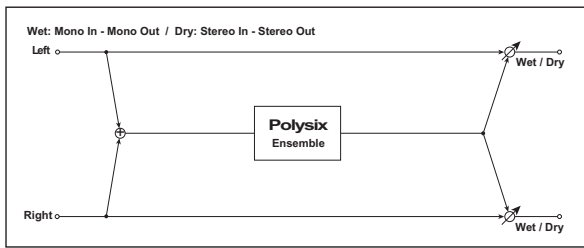

Parameter	Value	Explanation
Depth	← 0...100	Sets the depth of the effect
Src	Source Off...Tempo	Selects the modulation source that will control the effect depth
Amt	Amount -100...+100	Sets the amount by which the effect depth will be modulated
Wet/Dry	← Dry, 1 : 99... 99 : 1, Wet	Sets the balance between the effect and the dry input
Src	Source Off...Tempo	Selects a modulation source for Wet/Dry
Amt	Amount -100...+100	Sets the modulation amount for Wet/Dry

072: Stereo Flanger

This effect gives a significant swell and movement of pitch to the sound. It is more effective when applied to a sound with a lot of harmonics. This is a stereo flanger. You can add spread to the sound by offsetting the phase of the left and right LFOs from each other.

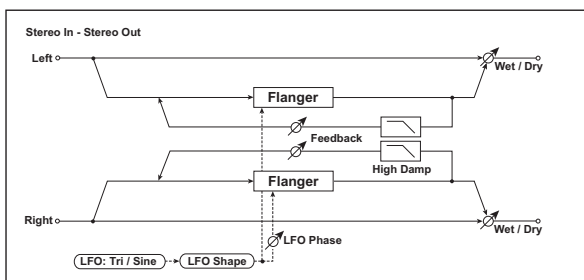

Parameter	Value	Explanation
LFO	LFO Waveform Tri (Triangle), Sine	Selects the LFO Waveform
Shape	LFO Shape -100...+100	Changes the curvature of the LFO Waveform p.214
Phase	Phase [deg] -180...+180	Sets the LFO phase difference between the left and right p.216
LFO [Hz]	LFO Freq [Hz] 0.02...20.00	Sets the speed of the LFO p.216
Src	Source Off...Tempo	Selects a modulation source for LFO speed
Amt	Amount -20.00... +20.00	Sets the modulation amount of LFO speed
MIDI Sync	BPM/MIDI Sync Off, On	When this is on, the LFO speed is set by BPM, Base Note, and Times, instead of Frequency p.213
BPM	← MIDI, 40.00... 300.00	MIDI syncs to the system tempo; 40-300 sets the tempo manually for this individual effect p.213

Base Note	←	Selects the type of notes that specify the LFO speed p.213
Times	← x1...x32	Sets the number of notes that specify the LFO speed p.213
Depth	← 0...100	Sets the depth of LFO modulation
Delay[ms]	Delay Time [ms] 0.0...50.0	Sets the delay time from the original sound
Feedback	← -100...+100	Sets the feedback amount p.246
HiDamp [%]	High Damp [%] 0...100	Sets the feedback damping amount in the high range p.246
Wet/Dry	← -Wet... -1 : 99, Dry, 1 : 99...Wet	Sets the balance between the effect and the dry input p.216, p.246
Src	Source Off...Tempo	Selects a modulation source for Wet/Dry
Amt	Amount -100...+100	Sets the modulation amount for Wet/Dry

Feedback

Wet/Dry

The peak shape of the positive and negative “Feedback” value is different. The harmonics will be emphasized when the effect sound is mixed with the dry sound if you set a positive value for both “Feedback” and “Wet/Dry,” and if you set a negative value for both “Feedback” and “Wet/Dry.”

High Damp [%]

This parameter sets the amount of damping of the feedback in the high range. Increasing the value will cut high-range harmonics.

073: Vintage Flanger

This models a classic analog flanger. It is highly effective for playing chords on clavi-type keyboards or electric piano.

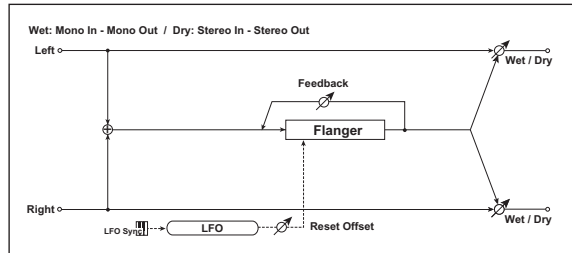

Parameter	Value	Explanation
Speed [Hz]	← 0.10...10.0	Sets the speed of LFO
Manual	← 1...100	Sets the sweep frequency
Depth	← 0...100	Sets the depth of LFO modulation
Resonance	← 0...100	Sets the resonance amount
LFO Reset	LFO Reset Source Off...Tempo	Selects a modulation source for LFO reset
Reset Offset	← 0...100	Sets the offset
Wet/Dry	← -Wet... -1 : 99, Dry, 1 : 99...Wet	Sets the balance between the effect and the dry input
Src	Source Off...Tempo	Selects a modulation source for Wet/Dry
Amt	Amount -100...+100	Sets the modulation amount for Wet/Dry

074: St. Random Flanger (Stereo Random Flanger)

The stereo effect uses a step-shape waveform and random LFO for modulation, creating a unique flanging effect.

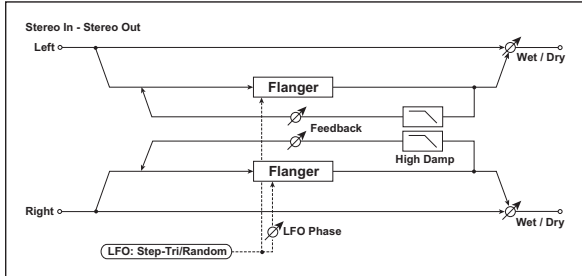

Paramter	Value	Explanation	
LFO	LFO Waveform	StpTri (Step-Tri), Rndm (Random)	Selects the LFO Waveform p.216
LFO Phase [deg]	←	-180...+180	Sets the LFO phase difference between the left and right p.216
LFO [Hz]	LFO Freq [Hz]	0.02...20.00	Sets the speed of the LFO p.216 D-mod
Src	Source	Off...Tempo	Selects the modulation source used for both LFO speed and step speed
Amt	Amount	-20.00...+20.00	Sets the modulation amount of LFO speed
Step[Hz]	Step Freq [Hz]	0.05...50.00	Sets the LFO step speed (speed that changes in steps) D-mod
Amt	Step Amount	-50.00...+50.00	Sets the modulation amount of LFO step speed
MIDI Sync	BPM/MIDI Sync	Off, On	When this is on, the LFO speed is set by BPM, Base Note, and Times, instead of Frequency p.213 A-Sync
BPM	←	MIDI, 40.00...300.00	MIDI syncs to the system tempo; 40-300 sets the tempo manually for this individual effect p.213
Base Note	←		Selects the type of notes that specify the LFO speed p.213
Times	←	x1...x32	Sets the number of notes that specify the LFO speed p.213
Step Base Note	←		Selects the type of notes to specify the LFO step speed p.216 A-Sync
Times	←	x1...x32	Sets the number of notes to specify the LFO step speed p.216
Depth	←	0...100	Sets the depth of LFO modulation
Delay[ms]	Delay Time [ms]	0.0...50.0	Sets the delay time from the original sound
Feedback	←	-100...+100	Sets the feedback amount p.246
HiDamp [%]	High Damp [%]	0...100	Sets the feedback damping amount in the high range p.246
Wet/Dry	←	-Wet...-99 : 1, Dry, 99 : 1...Wet	Sets the balance between the effect and the dry input p.216, p.246 D-mod
Src	Source	Off...Tempo	Selects a modulation source for Wet/Dry
Amt	Amount	-100...+100	Sets the modulation amount for Wet/Dry

075: St. Env. Flanger (Stereo Envelope Flanger)

This Flanger uses an envelope generator for modulation. You will obtain the same pattern of flanging each time you play. You can also control the Flanger directly using the modulation source.

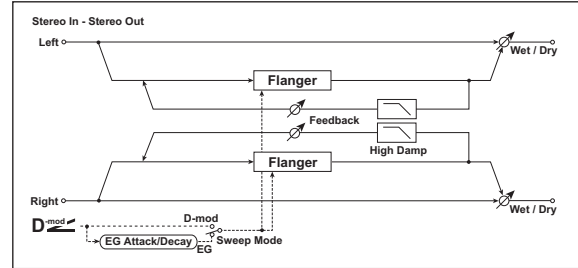

Paramter	Value	Explanation	
L Btm[ms]	L Delay Time Bottom [ms]	0.0...50.0	Sets the lower limit of the left-channel delay time
L Top[ms]	L Delay Time Top [ms]	0.0...50.0	Sets the upper limit of the left-channel delay time
R Btm[ms]	R Delay Time Bottom [ms]	0.0...50.0	Sets the lower limit of the right-channel delay time
R Top[ms]	R Delay Time Top [ms]	0.0...50.0	Sets the upper limit of the right-channel delay time
Sweep	Sweep Mode	EG, Dmod	Determines whether the flanger is controlled by the envelope generator or by the modulation source p.247
Src	Source	Off...Tempo	Selects the modulation source that triggers the EG (when Sweep Mode = EG), or the modulation source that causes the flanger to sweep (when Sweep Mode = Dmod) p.247 D-mod
EG Attack	←	1...100	Sets the EG attack speed p.248
EG Decay	←	1...100	Sets the EG decay speed p.248
Feedback	←	-100...+100	Sets the feedback amount p.246
HiDamp [%]	High Damp [%]	0...100	Sets the feedback damping amount in the high range p.246
Wet/Dry	←	-Wet...-99 : 1, Dry, 99 : 1...Wet	Sets the balance between the effect and the dry input p.216, p.246 D-mod
Src	Source	Off...Tempo	Selects a modulation source for Wet/Dry
Amt	Amount	-100...+100	Sets the modulation amount for Wet/Dry

Sweep Mode Source

This parameter switches the flanger control mode. With “Sweep Mode” = EG, the flanger will sweep using the envelope generator. This envelope generator is included in the envelope flanger, and not related to the Pitch EG, Filter EG, or Amp EG.

The “Source” parameter selects the source that starts the envelope generator. If you select, for example, Gate, the envelope generator will start when the note-on message is received.

When “Sweep Mode” = Dmod, the modulation source can control the flanger directly. Select the modulation source using the “Source” parameter.

MIDI The effect is off when a value for the modulation source specified for the “Source” parameter is smaller than 64, and the effect is on when the value is 64 or higher. The Envelope Generator is triggered when the value changes from 63 or smaller to 64 or higher.

EG Attack

EG Decay

Attack and Decay speed are the only adjustable parameters on this EG.

076: Stereo Vibrato

This effect causes the pitch of the input signal to shimmer. Using the AutoFade allows you to increase or decrease the shimmering speed.

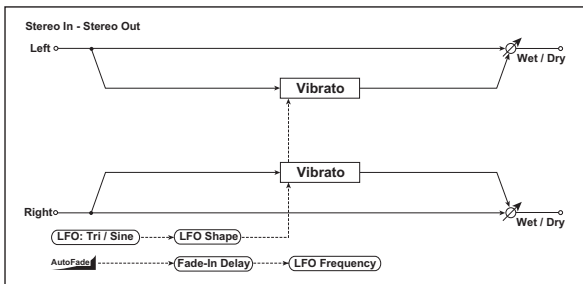

Parameter	Value	Explanation
LFO	LFO Waveform Tri (Triangle), Sine	Selects the LFO Waveform
LFO Shape	← -100...+100	Changes the curvature of the LFO Waveform p.216
LFO [Hz]	LFO Freq [Hz] 0.02...20.00	Sets the speed of the LFO Dmod
Src	Source Off...Tempo	Selects a modulation source for LFO speed
Amt	Amount -20.00...+20.00	Sets the modulation amount of LFO speed
MIDI Sync	BPM/MIDI Sync Off, On	When this is on, the LFO speed is set by BPM, Base Note, and Times, instead of Frequency p.213 Bsync
BPM	← MIDI, 40.00...300.00	MIDI syncs to the system tempo; 40-300 sets the tempo manually for this individual effect p.213
Base Note	← [Musical Note]	Selects the type of notes that specify the LFO speed p.213
Times	← x1...x32	Sets the number of notes that specify the LFO speed p.213
Depth	Vibrato Depth 0...100	Sets the depth of LFO modulation Dmod
Src	Source Off...Tempo	Selects the modulation source of the LFO modulation depth
Amt	Amount -100...+100	Sets the modulation amount of the LFO modulation depth
LFO Mod	LFO Freq Mod Dmod, AUTOFADE	Switches between Dmod and AUTOFADE for the LFO frequency modulation p.248
AUTOFADE	AUTOFADE Source Off...Tempo	Selects the modulation source that starts AutoFade p.248 Dmod
Fade-In[ms]	Fade-In Delay [ms] 00...2000	Sets the fade-in delay time p.248
Fade-In Rate	← 1...100	Sets the rate of fade-in p.248
Wet/Dry	← Dry, 1 : 99... 99 : 1, Wet	Sets the balance between the effect and the dry input Dmod

Src	Source	Off...Tempo	Selects a modulation source for Wet/Dry
Amt	Amount	-100...+100	Sets the modulation amount for Wet/Dry

AUTOFADE Source

Fade-In Delay [ms]

Fade-In Rate

LFO Freq Mod

When “LFO Freq Mod” is set to AUTOFADE, you can use the modulation source selected in “AUTOFADE Source” as a trigger to automatically fade in the modulation amount. When “MIDI Sync” is set to On, you cannot use this.

The “Fade-In Rate” parameter specifies the rate of fade-in. The “Fade-In Delay” parameter determines the time from AutoFade modulation source On until the fade-in starts.

The following is an example of a fade-in where the LFO speed is increased from “1.0Hz” to “4.0Hz” when a note-on message is received.

“AUTOFADE Source”=Gate1, “LFO Freq Mod” = AUTOFADE, “LFO Freq [Hz]”=1.0, “Amount”=3.0

MIDI The effect is off when a value for the dynamic modulation source specified for the “AUTOFADE Source” parameter is smaller than 64, and the effect is on when the value is 64 or higher. The AutoFade function is triggered when the value changes from 63 or smaller to 64 or higher.

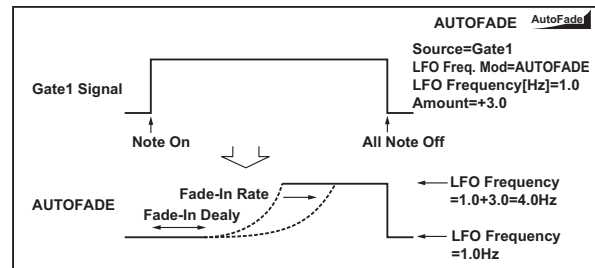

077: St. Auto Fade Mod. (Stereo Auto Fade Modulation)

This stereo chorus/flanger effect enables you to control the LFO speed and effect balance using auto fade, and you can spread the sound by offsetting the phase of the left and right LFOs from each other.

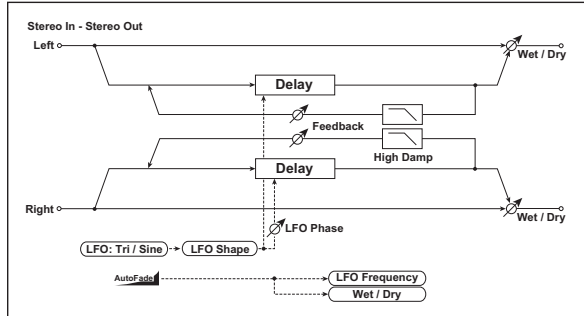

Paramter	Value	Explanation	
AUTOFADE	AUTOFADE Source	Off...Tempo	Selects the modulation source that starts AutoFade p.248
Fade-In[ms]	Fade-In Delay [ms]	00...2000	Sets the fade-in delay time p.248
Fade-In Rate	←	1...100	Sets the rate of fade-in p.248
LFO Mod	LFO Freq Mod	Dmod, AUTOFADE	Switches between Dmod and AUTOFADE for the LFO frequency modulation p.248
W/D Mod	Wet/Dry Mod	Dmod, AUTOFADE	Switches between Dmod and AUTOFADE for the effect balance modulation p.248
LFO	LFO Waveform	Tri (Triangle), Sine	Selects the LFO Waveform
Shape	LFO Shape	-100...+100	Changes the curvature of the LFO Waveform p.214
Phase	Phase [deg]	-180...+180	Sets the LFO phase difference between the left and right p.216
LFO [Hz]	LFO Freq [Hz]	0.02...20.00	Sets the speed of the LFO
Src	Source	Off...Tempo	Selects a modulation source for LFO speed
Amt	Amount	-20.00...+20.00	Sets the modulation amount of LFO speed
Depth	←	0...100	Sets the depth of LFO modulation
L Dly[ms]	Mod Delay L Delay Time [ms]	0.0...45.0	Sets the left channel delay time
R Dly[ms]	Mod Delay R Delay Time [ms]	0.0...45.0	Sets the right channel delay time
Feedback	←	-100...+100	Sets the feedback amount p.246
HiDamp [%]	High Damp [%]	0...100	Sets the feedback damping amount in the high range p.246
Wet/Dry	←	-Wet...-99 : 1, Dry, 99 : 1...Wet	Sets the balance between the effect and the dry input p.216, p.246
Src	Source	Off...Tempo	Selects a modulation source for Wet/Dry
Amt	Amount	-100...+100	Sets the modulation amount for Wet/Dry

078: Doppler

This effect simulates the “Doppler effect” of a moving sound with a changing pitch, similar to the siren of a passing ambulance. Mixing the effect sound with the dry sound will create a unique chorus effect.

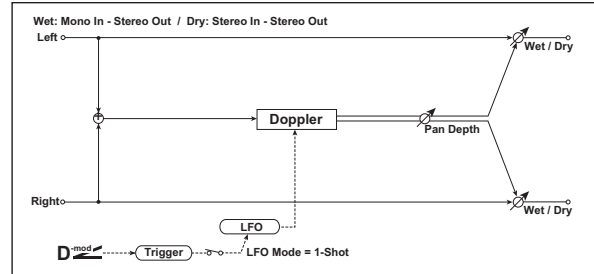

Paramter	Value	Explanation	
LFO Mode	←	Loop, 1-Shot	Switches LFO operation mode p.249
Sync	LFO Sync	Off, On	Switches between LFO reset on and off when LFO Mode is set to Loop p.249
Src	Source	Off...Tempo	Selects the modulation source of LFO reset p.249
LFO [Hz]	LFO Freq [Hz]	0.02...20.00	Sets the speed of the LFO p.216
Src	Source	Off...Tempo	Selects a modulation source for LFO speed
Amt	Amount	-20.00...+20.00	Sets the modulation amount of LFO speed
MIDI Sync	BPM/MIDI Sync	Off, On	When this is on, the LFO speed is set by BPM, Base Note, and Times, instead of Frequency p.213
BPM	←	MIDI, 40.00...300.00	MIDI syncs to the system tempo; 40–300 sets the tempo manually for this individual effect p.213
Base Note	←	🎵	Selects the type of notes that specify the LFO speed p.213
Times	←	x1...x32	Sets the number of notes that specify the LFO speed p.213
PitchDepth	Pitch Depth	0...100	Sets the pitch variation of the moving sound p.250
Src	Source	Off...Tempo	Selects the modulation source of pitch variation
Amt	Amount	-100...+100	Sets the modulation amount of pitch variation
Pan Depth	←	-100...+100	Sets the panning of the moving sound p.250
Src	Source	Off...Tempo	Selects the modulation source of panning
Amt	Amount	-100...+100	Sets the modulation amount of panning
Wet/Dry	←	Dry, 1 : 99...99 : 1, Wet	Sets the balance between the effect and the dry input
Src	Source	Off...Tempo	Selects a modulation source for Wet/Dry
Amt	Amount	-100...+100	Sets the modulation amount for Wet/Dry

LFO Mode

Source

LFO Sync

The “LFO Mode” parameter switches LFO operation mode. When Loop is selected, the Doppler effect will be created repeatedly. If “LFO Sync” is set to On, the LFO will be reset when the

modulation source specified with the “Source” parameter is turned on.

When “LFO Mode” is set to 1-Shot, the Doppler effect is created only once when the modulation source specified in the “Source” field is turned on. At this time if you do not set the “Source” parameter, the Doppler effect will not be created, and no effect sound will be output.

MIDI The effect is off when a value for the modulation source specified for the “Source” parameter is smaller than 64, and the effect is on when the value is 64 or higher. The Doppler effect is triggered when the value changes from 63 or smaller to 64 or higher.

Pitch Depth

With the Doppler effect, the pitch is raised when the sound approaches, and the pitch is lowered when the sound goes away. This parameter sets this pitch variation.

Pan Depth

This parameter sets the width of the stereo image of the effect sound. With larger values, the sound seems to come and go from much further away. With positive values, the sound moves from left to right; with negative values, the sound moves from right to left.

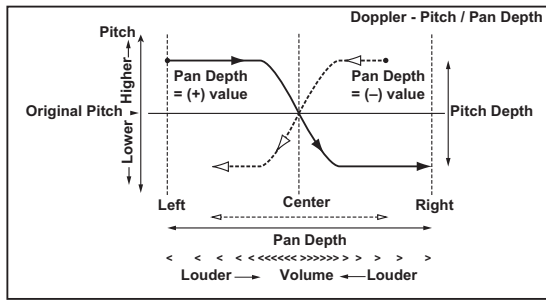

079: Detune

Using this effect, you can obtain a detune effect that offsets the pitch of the effect sound slightly from the pitch of the input signal. Compared to the chorus effect, a more natural sound thickness will be created.

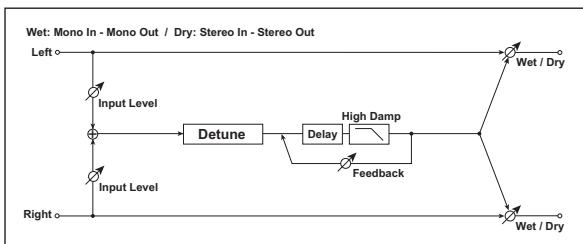

Parameter	Value	Explanation		
Pitch [c]	Pitch Shift [cents]	-100...+100	Sets the pitch difference from the input signal	D^{mod}
Src	Source	Off...Tempo	Selects a modulation source for pitch shift	
Amt	Amount	-100...+100	Sets the modulation amount for pitch shift	
Delay[ms]	Delay Time [ms]	0...1000	Sets the delay time	
Feedback		-100...+100	Sets the feedback amount	
HiDamp [%]	High Damp [%]	0...100	Sets the damping amount in the high range	
InLvl Dmod [%]	Input Level Dmod [%]	-100...+100	Sets the modulation amount of the input level	D^{mod}

Src	Source	Off...Tempo	Selects the modulation source for the input level	p.250	
Wet/Dry	←	Dry, 1 : 99... 99 : 1, Wet	Sets the balance between the effect and the dry input		D^{mod}
Src	Source	Off...Tempo	Selects a modulation source for Wet/Dry		
Amt	Amount	-100...+100	Sets the modulation amount for Wet/Dry		

Input Level Dmod [%]

Source

This parameter sets the dynamic modulation of the input level.

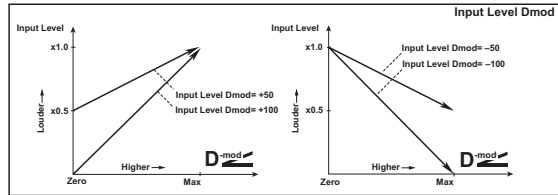

080: Pitch Shifter

This effect changes the pitch of the input signal. You can select from three types: Fast (quick response), Medium, and Slow (preserves tonal quality). You can also create an effect where the pitch is gradually raised (or dropped) using the delay with feedback.

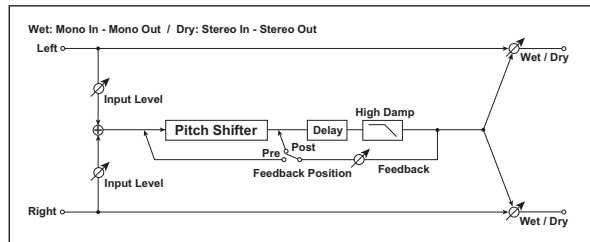

Parameter	Value	Explanation			
Mode	←	Med...Fast	Switches Pitch Shifter mode	p.251	
Pitch Shift	Shift [1/2tone]	-24...+24	Sets the pitch shift amount by steps of a semitone	p.251	D^{mod}
Src	Source	Off...Tempo	Selects the modulation source of pitch shift amount	p.251	
Amt	Amount	-24...+24	Sets the modulation amount of pitch shift amount	p.251	
Fine [cents]	←	-100...+100	Sets the pitch shift amount by steps of a cent	p.251	D^{mod}
Amt	Amount [cents]	-100...+100	Sets the modulation amount of pitch shift amount	p.251	
Delay[ms]	Delay Time [ms]	0...2000	Sets the delay time		
Feedback Position	←	Pre, Post	Switches the feedback connection	p.251	
Feedback	←	-100...+100	Sets the feedback amount	p.251	
HiDamp [%]	High Damp [%]	0...100	Sets the damping amount in the high range		
InLvl Dmod [%]	Input Level Dmod [%]	-100...+100	Sets the modulation amount of the input level	p.250	D^{mod}
Src	Source	Off...Tempo	Selects the modulation source for the input level	p.250	

Wet/Dry	←	Dry, 1 : 99... 99 : 1, Wet	Sets the balance between the effect and the dry input	D ^{mod}
Src	Source	Off...Tempo	Selects a modulation source for Wet/Dry	
Amt	Amount	-100...+100	Sets the modulation amount for Wet/Dry	

Mode

This parameter switches the pitch shifter operating mode. With Slow, tonal quality will not be changed too much. With Fast, the effect becomes a Pitch Shifter that has a quick response, but may change the tone. Medium is in-between these two. If you do not need to set a significant pitch shift amount, set this parameter to Slow. If you wish to change the pitch significantly, use Fast.

Shift [1/2tone]

Source

Amount

Fine [cents]

Amount [cents]

The amount of pitch shift will use the value of the “Pitch Shift” plus the “Fine” value. The amount of modulation will use the Pitch Shift Amount value plus the Fine Amount.

The same Modulation Source is used for both “Pitch Shift” and “Fine.”

Feedback Position

Feedback

When “Feedback Position” is set to **Pre**, the pitch shifter output is again input to the pitch shifter. Therefore, if you specify a higher value for the Feedback parameter, the pitch will be raised (or lowered) more and more each time that feedback is repeated. If “Feedback Position” is set to **Post**, the feedback signal will not pass through the pitch shifter again. Even if you specify a higher value for the “Feedback” parameter, the pitch-shifted sound will be repeated at the same pitch.

081: Pitch Shift Mod. (Pitch Shift Modulation)

This effect modulates the detuned pitch shift amount using an LFO, adding a clear spread and width to the sound by panning the effect sound and dry sound to the left and right. This is especially effective when the effect sound and dry sound output from stereo speakers are mixed.

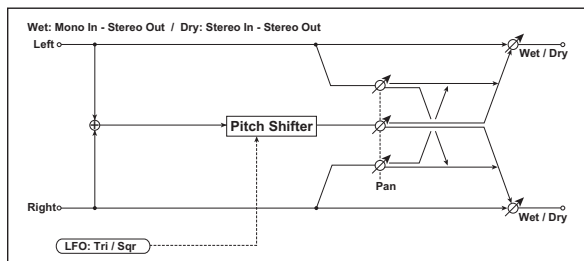

Parameter	Value	Explanation	
Pitch [c]	Pitch Shift [cents]	-100...+100	Sets the pitch difference from the input signal p.251
LFO	LFO Waveform	Tri (Triangle), Square	Selects the LFO Waveform
LFO [Hz]	LFO Freq [Hz]	0.02...20.00	Sets the speed of the LFO p.216
Src	Source	Off...Tempo	Selects a modulation source for LFO speed
Amt	Amount	-20.00...+20.00	Sets the modulation amount of LFO speed

MIDI Sync	BPM/MIDI Sync	Off, On	When this is on, the LFO speed is set by BPM, Base Note, and Times, instead of Frequency p.213	A ^{sync}
BPM	←	MIDI, 40.00... 300.00	MIDI syncs to the system tempo; 40-300 sets the tempo manually for this individual effect p.213	
Base Note	←	♩... ♭... ♮... ♯...	Selects the type of notes that specify the LFO speed p.213	
Times	←	x1...x32	Sets the number of notes that specify the LFO speed p.213	
Depth	←	-100...+100	Sets the LFO modulation depth for pitch shift amount p.251	D ^{mod}
Src	Source	Off...Tempo	Selects the modulation source of the depth of modulation	
Amt	Amount	-100...+100	Sets the modulation amount of the depth of modulation	
Pan	←	L, 1 : 99...99 : 1, R	Sets the panning effect sound and dry sound separately p.251	
Wet/Dry	←	Dry, 1 : 99... 99 : 1, Wet	Sets the balance between the effect and the dry input p.251	D ^{mod}
Src	Source	Off...Tempo	Selects a modulation source for Wet/Dry	
Amt	Amount	-100...+100	Sets the modulation amount for Wet/Dry	

Pitch Shift [cents]

Depth

These parameters set the amount of pitch shift and the amount of modulation by means of the LFO.

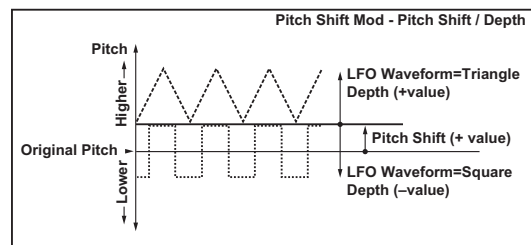

Pan

Wet/Dry

The Pan parameter pans the effect sound and dry sound to the left and right. With L, the effect sound is panned left, and the dry sound is panned right. With a Wet/Dry = Wet setting, the effect and dry sound will be output in a proportion of 1:1.

082: P4EQ - Cho/Flng (Parametric 4-Band EQ - Chorus/Flanger)

This effect combines a mono four-band parametric equalizer and a chorus/flanger.

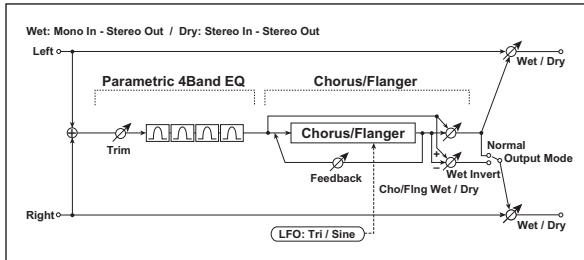

Parameter	Value	Explanation
Parametric 4-Band EQ		
E Trim	Trim	0...100 Sets the parametric EQ input level
E B1 F[Hz]	Band1 Cutoff [Hz]	20...1.00k Sets the center frequency of Band 1
Q	Band1 Q	0.5...10.0 Sets the bandwidth of Band 1 p.211
Gain[dB]	Band1 Gain [dB]	-18...+18 Sets the gain of Band 1
E B2 F[Hz]	Band2 Cutoff [Hz]	50...5.00k Sets the center frequency of Band 2
Q	Band2 Q	0.5...10.0 Sets the bandwidth of Band 2 p.211
Gain[dB]	Band2 Gain [dB]	-18...+18 Sets the gain of Band 2
E B3 F[Hz]	Band3 Cutoff [Hz]	300...10.00k Sets the center frequency of Band 3
Q	Band3 Q	0.5...10.0 Sets the bandwidth of Band 3 p.211
Gain[dB]	Band3 Gain [dB]	-18...+18 Sets the gain of Band 3
E B4 F[Hz]	Band4 Cutoff [Hz]	500...20.00k Sets the center frequency of Band 4
Q	Band4 Q	0.5...10.0 Sets the bandwidth of Band 4 p.211
Gain[dB]	Band4 Gain [dB]	-18...+18 Sets the gain of Band 4
Chorus/Flanger		
F LFO[Hz]	LFO Freq [Hz]	0.02...20.00 Sets the speed of the LFO
LFO	LFO Waveform	Tri (Triangle), Sine Selects the LFO Waveform
F Depth	Depth	0...100 Sets the depth of LFO modulation
Dly[ms]	Delay Time [ms]	0.0...110.0 Sets the delay time
F.back	Feedback	-100...+100 Sets the feedback amount p.246
F Wet/Dry	[Cho/Fln] Wet/Dry	-Wet...-1 : 99, Dry, 1 : 99...Wet Sets the effect balance of the chorus/flanger p.216, p.246
Src	[Cho/Fln] Source	Off...Tempo Selects the Wet/Dry modulation source for the chorus/flanger
Amt	[Cho/Fln] Amount	-100...+100 Sets the Wet/Dry modulation amount for the chorus/flanger
F Out Mode	Output Mode	Normal, Wet Invert Selects the output mode for the chorus/flanger p.243
Wet/Dry	←	-Wet...-1:99, Dry, 1:99...Wet Sets the balance between the effect and the dry input
Src	Source	Off...Tempo Selects a modulation source for Wet/Dry
Amt	Amount	-100...+100 Sets the modulation amount for Wet/Dry

083: Comp - Cho/Flng (Compressor - Chorus/Flanger)

This effect combines a mono compressor and a chorus/flanger. You can change the order of the effects.

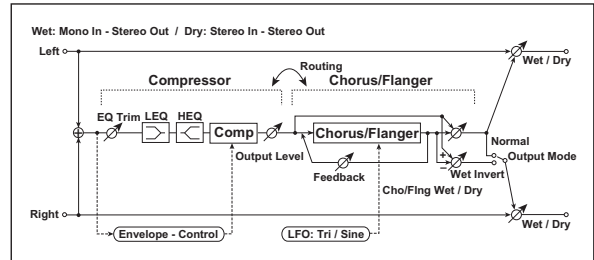

Parameter	Value	Explanation
Compressor		
C Sens	Sensitivity	1...100 Sets the sensitivity p.207
C Attack	Attack	1...100 Sets the attack level p.207
Out Level	Output Level	0...100 Sets the compressor output level p.207
C EQ Trim	←	0...100 Sets the EQ input level
C LEQ [dB]	C Low EQ Gain [dB]	-15...+15 Sets the gain of Low EQ
HEQ [dB]	High EQ Gain [dB]	-15...+15 Sets the gain of High EQ
Chorus/Flanger		
F LFO[Hz]	LFO Freq [Hz]	0.02...20.00 Sets the speed of the LFO
LFO	LFO Waveform	Tri (Triangle), Sine Selects the LFO Waveform
F Depth	Depth	0...100 Sets the depth of LFO modulation
Dly [ms]	Delay Time [ms]	0.0...109.0 Sets the delay time
F.back	Feedback	-100...+100 Sets the feedback amount p.246
F Wet/Dry	[Cho/Fln] Wet/Dry	-Wet...-1 : 99, Dry, 1 : 99...Wet Sets the effect balance of the chorus/flanger p.216, p.246
Src	[Cho/Fln] Source	Off...Tempo Selects the Wet/Dry modulation source for the chorus/flanger
Amt	[Cho/Fln] Amount	-100...+100 Sets the Wet/Dry modulation amount for the chorus/flanger
F Out Mode	Output Mode	Normal, Wet Invert Selects the output mode for the chorus/flanger p.252
Routing	←	Comp→Flanger, Flanger→Comp Switches the order of the compressor and chorus/flanger p.252
Wet/Dry	←	-Wet...-99 : 1, Dry, 99 : 1...Wet Sets the balance between the effect and the dry input
Src	Source	Off...Tempo Selects a modulation source for Wet/Dry
Amt	Amount	-100...+100 Sets the modulation amount for Wet/Dry

Output Mode Routing

When Wet Invert is selected, the right channel phase of the chorus/flanger effect sound is inverted. This creates pseudo-stereo effects and adds spread.

However, if a mono-input type effect is connected after this effect, the left and right sounds may cancel each other, eliminating the chorus/flanger effects.

When "Routing" is set to Flanger→Comp, "Output Mode" will be set to Normal.

084: Limiter - Cho/Flng (Limiter - Chorus/Flanger)

This effect combines a mono limiter and a chorus/flanger. You can change the order of the effects.

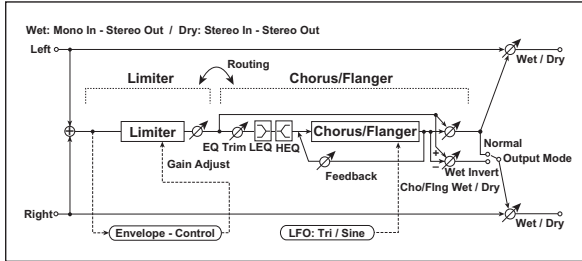

Parameter	Value	Explanation
Limiter		
L Ratio	←	1.0 : 1... 50.0 : 1, Inf : 1 Sets the signal compression ratio p.208
Thrsh [dB]	Threshold [dB]	-40...0 Sets the level above which the compressor is applied p.208
L Attack	←	1...100 Sets the attack time
Release	←	1...100 Sets the release time
L Gain [dB]	Gain Adjust [dB]	-Inf, -38...+24 Sets the limiter output gain p.208
Chorus/Flanger		
F LFO[Hz]	LFO Freq [Hz]	0.02...20.00 Sets the speed of the LFO
LFO	LFO Waveform	Tri (Triangle), Sine Selects the LFO Waveform
F Depth	Depth	0...100 Sets the depth of LFO modulation
Dly[ms]	Delay Time [ms]	0.0...110.0 Sets the delay time
F.back	Feedback	-100...+100 Sets the feedback amount p.246
F EQ Trim	Pre EQ Trim	0...100 Sets the EQ input level
F LEQ [dB]	Low EQ Gain [dB]	-15...+15 Sets the gain of Low EQ
HEQ [dB]	High EQ Gain [dB]	-15...+15 Sets the gain of High EQ
F Wet/Dry	[Cho/Fln] Wet/Dry	-Wet... -1 : 99, Dry, 1 : 99...Wet Sets the effect balance of the chorus/flanger p.216, p.246
Src	[Cho/Fln] Source	Off...Tempo Selects the Wet/Dry modulation source for the chorus/flanger
Amt	[Cho/Fln] Amount	-100...+100 Sets the Wet/Dry modulation amount for the chorus/flanger
F Out	Output Mode	Normal, Wet Invert Selects the output mode for the chorus/flanger p.252
Routing	←	Limiter → Flanger, Flanger → Limiter Switches the order of the limiter and chorus/flanger
Wet/Dry	←	-Wet... -99 : 1, Dry, 99 : 1...Wet Sets the balance between the effect and the dry input
Src	Source	Off...Tempo Selects a modulation source for Wet/Dry
Amt	Amount	-100...+100 Sets the modulation amount for Wet/Dry

085: Exciter - Cho/Flng (Exciter - Chorus/Flanger)

This effect combines a mono limiter and a chorus/flanger.

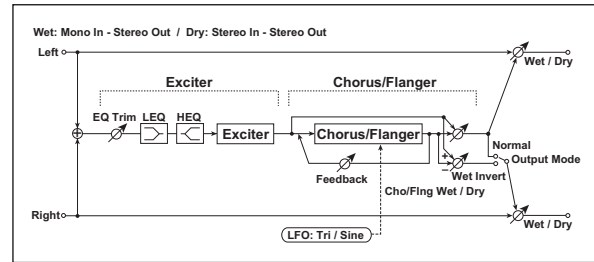

Parameter	Value	Explanation
Exciter		
X Blend	Blend	-100...+100 Sets the intensity (depth) of the Exciter effect p.212
Frequency	Emphasis Freq	0...70 Sets the frequency range to be emphasized p.212
X EQ Trim	←	0...100 Sets the EQ input level
X LEQ [dB]	Low EQ Gain [dB]	-15...+15 Sets the gain of Low EQ
HEQ [dB]	High EQ Gain [dB]	-15...+15 Sets the gain of High EQ
Chorus/Flanger		
F LFO[Hz]	LFO Freq [Hz]	0.02...20.00 Sets the speed of the LFO
LFO	LFO Waveform	Tri (Triangle), Sine Selects the LFO Waveform
F Depth	Depth	0...100 Sets the depth of LFO modulation
Dly[ms]	Delay Time [ms]	0.0...109.0 Sets the delay time
F.back	Feedback	-100...+100 Sets the feedback amount p.246
F Out Mode	←	Normal, Wet Invert Selects the output mode for the chorus/flanger p.208
F Wet/Dry	[Cho/Fln] Wet/Dry	-Wet... -1 : 99, Dry, 1 : 99...Wet Sets the effect balance of the chorus/flanger p.216, p.246
Src	[Cho/Fln] Source	Off...Tempo Selects the Wet/Dry modulation source for the chorus/flanger
Amt	[Cho/Fln] Amount	-100...+100 Sets the Wet/Dry modulation amount for the chorus/flanger
Wet/Dry	←	-Wet... -99 : 1, Dry, 99 : 1...Wet Sets the balance between the effect and the dry input
Src	Source	Off...Tempo Selects a modulation source for Wet/Dry
Amt	Amount	-100...+100 Sets the modulation amount for Wet/Dry

086: OD/HG - Cho/Fing (Overdrive/Hi.Gain - Chorus/Flanger)

This effect combines a mono overdrive/high-gain distortion and a chorus/flanger. You can change the order of the effects.

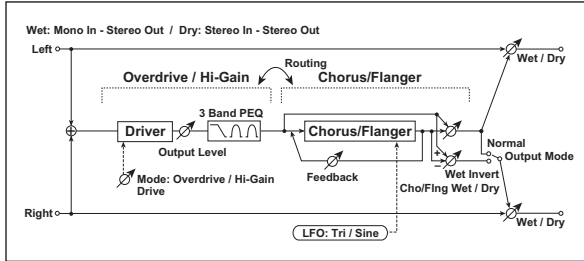

Parameter	Value	Explanation
Overdrive/Hi-Gain		
O Mode	Drive Mode	OverD (Overdrive), Hi-Gain
Drive	←	Sets the degree of distortion p.220
O Out Level	Level	Sets the overdrive output level p.220
Src	Source	Off...Tempo
Amt	Amount	-50...+50
O Low [Hz]	Low Cutoff [Hz]	20...1.00k
O Low [dB]	Low Gain [dB]	-18...+18
O Mid1 [Hz]	Mid1 Cutoff [Hz]	300...10.00k
Q	Mid1 Q	0.5...10.0
Gain[dB]	Mid1 Gain [dB]	-18...+18
O Mid2 [Hz]	Mid2 Cutoff [Hz]	500...20.00k
Q	Mid2 Q	0.5...10.0
Gain[dB]	Mid2 Gain [dB]	-18...+18
Chorus/Flanger		
F LFO [Hz]	LFO Freq [Hz]	0.02...20.00
LFO	LFO Waveform	Tri (Triangle), Sine
F Depth	Depth	0...100
Dly [ms]	Delay Time [ms]	0.0...110.0
F.back	Feedback	-100...+100
F Wet/Dry	[Cho/Fln] Wet/Dry	-Wet...-1 : 99, Dry, 1 : 99...Wet
Src	[Cho/Fln] Source	Off...Tempo
Amt	[Cho/Fln] Amount	-100...+100
F Out Mode	←	Normal, Wet Invert

Routing	←	OD/HG → Flanger, Flanger → OD/HG	Switches the order of the overdrive and chorus / flanger
Wet/Dry	←	Dry, 1 : 99... 99 : 1, Wet	Sets the balance between the effect and the dry input
Src	Source	Off...Tempo	Selects a modulation source for Wet/Dry
Amt	Amount	-100...+100	Sets the modulation amount for Wet/Dry

087: Phaser - Cho/Fing (Phaser - Chorus/Flanger)

This effect combines a mono phaser and a chorus/flanger.

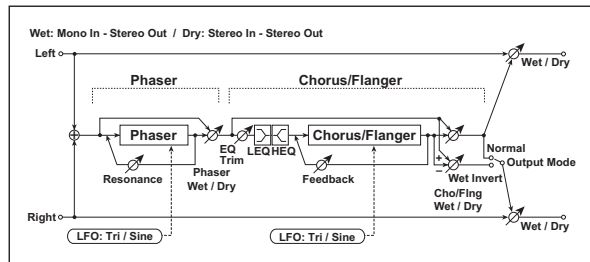

Parameter	Value	Explanation
Phaser		
P LFO [Hz]	LFO Freq [Hz]	0.02...20.00
LFO	LFO Waveform	Tri (Triangle), Sine
P Depth	Depth	0...100
Manual	←	0...100
Reso	Resonance	-100...+100
P W/D	[Phaser] Wet/Dry	-Wet...-1 : 99, Dry, 1 : 99...Wet
Chorus/Flanger		
F LFO [Hz]	LFO Freq [Hz]	0.02...20.00
LFO	LFO Waveform	Tri (Triangle), Sine
F Depth	Depth	0...100
F Dly [ms]	Delay Time [ms]	0.0...110.0
F F.back	Feedback	-100...+100
F EQ Trim	Pre EQ Trim	0...100
F LEQ [dB]	Low EQ Gain [dB]	-15...+15
F HEQ [dB]	High EQ Gain [dB]	-15...+15
F W/D	[Cho/Fln] Wet/Dry	-Wet...-1 : 99, Dry, 1 : 99...Wet
Src	[Cho/Fln] Source	Off...Tempo
Amt	[Cho/Fln] Amount	-100...+100
F Out	Output Mode	Normal, Wet Invert
Wet/Dry	←	-Wet...-99 : 1, Dry, 99 : 1...Wet
Src	Source	Off...Tempo

Amt	Amount	-100...+100	Sets the modulation amount for Wet/Dry	
-----	--------	-------------	--	--

088: GrainSftr (Grain Shifter)

This effect cuts extremely short samples (“grains”) from the input signal waveform and plays them repeatedly, giving a mechanical character to the sound.

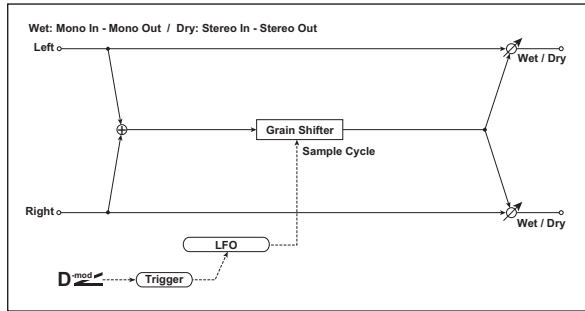

Paramter	Value	Explanation	
Duration	0...100	Sets the duration of the grain p.255	D-mod
Src	Source	Off...Tempo	
Amt	Amount	-100...+100	
LFO Sync	LFO Sync Src	Off...Tempo	D-mod
LFO [Hz]	LFO Sample Cycle [Hz]	0.02...20.00	D-mod
Src	Source	Off...Tempo	
Amt	Amount	-20.00...+20.00	
MIDI Sync	BPM/MIDI Sync	Off, On	Midi Sync
BPM	←	MIDI, 40.00...300.00	
Base Note	←	Notes that specify the LFO speed p.213	
Times	←	x1...x32	
Wet/Dry	←	Dry, 1 : 99... 99 : 1, Wet	D-mod
Src	Source	Off...Tempo	
Amt	Amount	-100...+100	

Duration

LFO Sample Cycle [Hz]

“Duration” sets the length of the sampled grain, and the “LFO Sample Cycle” controls how often a new grain is sampled. In between Sample Cycles, the current grain is repeated continuously.

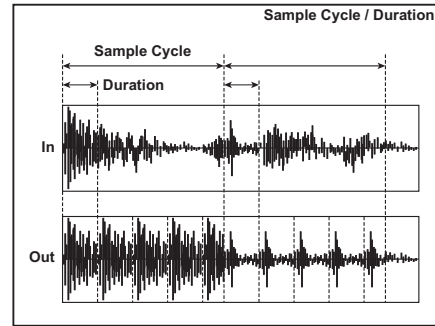

089: L/C/R Delay

This multitap delay outputs three Tap signals to the left, right, and center respectively. You can also adjust the left and right spread of the delay sound.

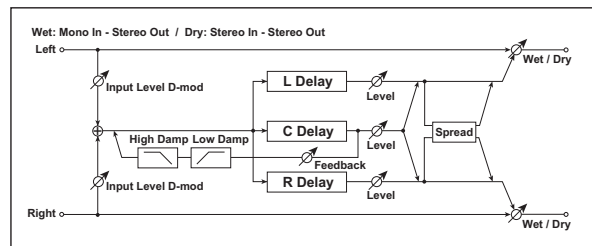

Paramter	Value	Explanation	
L Dly[ms]	L Delay Time [ms]	0...2730	Sets the delay time of TapL
L Level	Level	0...50	Sets the output level of TapL
C Dly[ms]	C Delay Time [ms]	0...2730	Sets the delay time of TapC
C Level	Level	0...50	Sets the output level of TapC
R Dly[ms]	R Delay Time [ms]	0...2730	Sets the delay time of TapR
Level	Level	0...50	Sets the output level of TapR
Feedback C	C Delay Feedback	-100...+100	Sets the feedback amount of TapC
Src	Source	Off...Tempo	
Amt	Amount	-100...+100	Sets the modulation amount of the TapC feedback amount
HiDamp[%]	High Damp [%]	0...100	Sets the damping amount in the high range p.256
LoDamp[%]	Low Damp [%]	0...100	Sets the damping amount in the low range p.256
InLvl Dmod	Input Level Dmod [%]	-100...+100	Sets the modulation amount of the input level p.250
Src	Source	Off...Tempo	Sets the modulation source for the input level p.250
Spread	←	0...50	Sets the width of the stereo image of the effect sound p.256
Wet/Dry	←	Dry, 1 : 99... 99 : 1, Wet	D-mod
Src	Source	Off...Tempo	Sets a modulation source for Wet/Dry
Amt	Amount	-100...+100	Sets the modulation amount for Wet/Dry

High Damp [%]

Low Damp [%]

These parameters set the damping amount of high range and low range. The tone of the delayed sound becomes darker and lighter as it feeds back.

Spread

This parameter sets the pan width of the effect sound. The stereo image is widest with a value of 50, and the effect sound of both channels is output from the center with a value of 0.

090: Stereo/CrossDelay

This is a stereo delay, and can be used as a cross-feedback delay effect in which the delay sounds cross over between the left and right by changing the feedback routing.

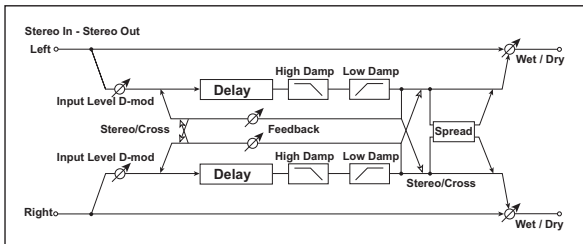

Paramter	Value	Explanation
Mode	←	Stereo, Cross Switches between stereo delay and cross-feedback delay
L DL[ms]	L Delay [ms]	0.0...274.0 Sets the delay time for the left channel
R DL[ms]	R Delay [ms]	0.0...274.0 Sets the delay time for the right channel
L Feedback	L Feedback	-100...+100 Sets the feedback amount for the left channel
Src	Source	Off...Tempo Selects the modulation source of feedback amount
Amt	Amount	-100...+100 Sets the modulation amount of the left channel feedback
R Feedback	R Feedback	-100...+100 Sets the feedback amount for the right channel
Amt	Amount	-100...+100 Sets the modulation amount of the right channel feedback
HiDamp[%]	High Damp [%]	0...100 Sets the damping amount in the high range p.256
LoDamp[%]	Low Damp [%]	0...100 Sets the damping amount in the low range p.256
InLvl Dmod	Input Level Dmod [%]	-100...+100 Sets the modulation amount of the input level p.250
Src	Source	Off...Tempo Selects the modulation source for the input level p.250
Spread	←	-50...+50 Sets the width of the stereo image of the effect sound p.256
Wet/Dry	←	Dry, 1 : 99... 99 : 1, Wet Sets the balance between the effect and the dry input
Src	Source	Off...Tempo Selects a modulation source for Wet/Dry
Amt	Amount	-100...+100 Sets the modulation amount for Wet/Dry

091: St. Multitap Delay (Stereo Multitap Delay)

The left and right Multitap Delays have two taps respectively. Changing the routing of feedback and tap output allows you to create various patterns of complex effect sounds.

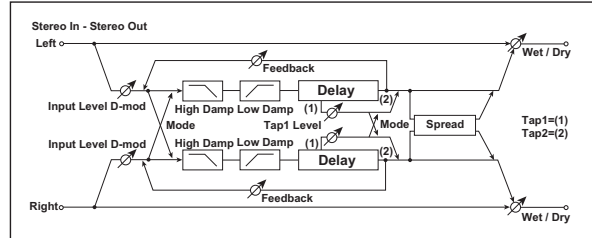

Paramter	Value	Explanation
Mode	←	Normal, Cross Feedback, Cross Pan1, Cross Pan2 Switches the left and right delay routing p.256
Hi Damp[%]	High Damp [%]	0...100 Sets the damping amount in the high range p.256
Lo Damp[%]	Low Damp [%]	0...100 Sets the damping amount in the low range p.256
Tap1[ms]	Tap1 Time [ms]	0.0...274.0 Sets the Tap1 delay time
Tap1 Level	Level	0...100 Sets the Tap1 output level p.257
Tap2[ms]	Tap2 Time [ms]	0.0...274.0 Sets the Tap2 delay time
Fback(T2)	Tap2 Feedback	-100...+100 Sets the Tap2 feedback amount
Src	Source	Off...Tempo Selects the modulation source of the Tap2 feedback amount
Amt	Amount	-100...+100 Sets the modulation amount of the Tap2 feedback amount
InLvl Dmod	Input Level Dmod [%]	-100...+100 Sets the modulation amount of the input level p.250
Src	Source	Off...Tempo Selects the modulation source for the input level p.250
Spread	←	-100...+100 Sets the width of the stereo image of the effect sound p.256
Src	Source	Off...Tempo Selects the modulation source of the effect sound's stereo image width
Amt	Amount	-100...+100 Sets the modulation amount of the effect sound's stereo image width
Wet/Dry	←	-Wet... -99 : 1, Dry, 99 : 1...Wet Sets the balance between the effect and the dry input
Src	Source	Off...Tempo Selects a modulation source for Wet/Dry
Amt	Amount	-100...+100 Sets the modulation amount for Wet/Dry

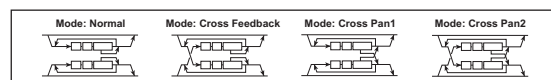

Mode

You can change how the left and right delay signals are panned by modifying the routing of the left and right delay as shown in the figure above. You need to input different sounds to each channel in order for this parameter to be effective.

Tap1 Level

This parameter sets the output level of Tap1. Setting a different level from Tap2 will add a unique touch to a monotonous delay and feedback.

092: St. Mod Delay (Stereo Modulation Delay)

This stereo delay uses an LFO to sweep the delay time. The pitch also varies, creating a delay sound which swells and shimmers. You can also control the delay time using a modulation source.

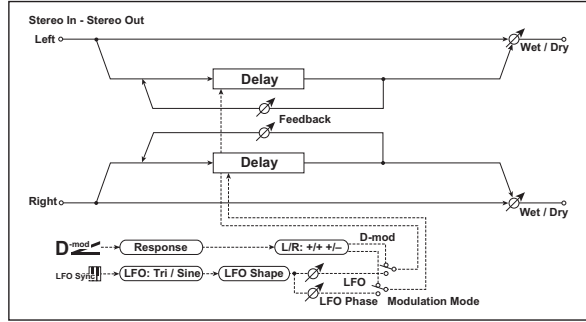

Parameter	Value	Explanation	
L Dly[ms]	L Delay Delay Time [ms]	0.0...259.0	Sets the delay time for the left channel
L Feedback	L Feedback	-100...+100	Sets the feedback amount of left delay
R Dly[ms]	R Delay Delay Time [ms]	0.0...259.0	Sets the delay time for the right channel
R Feedback	R Feedback	-100...+100	Sets the feedback amount of right delay
L Depth	←	0...200	Sets the depth of the left LFO modulation
L LFO Phase [deg]	←	-180...+180	Sets the phase obtained when the left LFO is reset p.257
R LFO Phase [deg]	←	-180...+180	Sets the phase obtained when the right LFO is reset p.257
R Depth	←	0...200	Sets the depth of the right LFO modulation
Mod Mode	Modulation Mode	LFO, Dmod	Switches between LFO modulation control and modulation source control
Dmod Mod	Dmod Modulation	L/R: +/+ , L/R: +/-	Reversed L/R control by modulation source p.257
Src	Source	Off...Tempo	Selects the modulation source that controls delay time
Resp	Response	0...30	Sets the rate of response to the modulation source
LFO	LFO Waveform	Tri (Triangle), Sine	Selects the LFO Waveform
LFO Shape	←	-100...+100	Changes the curvature of the LFO Waveform p.214
LFO [Hz]	LFO Freq [Hz]	0.02...20.00	Sets the speed of the LFO p.216
Sync	LFO Dmod Sync	Off, On	Switches LFO reset off/on p.257
Src	Source	Off...Tempo	Selects the modulation source that resets the LFO
MIDI Sync	BPM/MIDI Sync	Off, On	When this is on, the LFO speed is set by BPM, Base Note, and Times, instead of Frequency p.213

BPM	←	MIDI, 40.00...300.00	MIDI syncs to the system tempo; 40-300 sets the tempo manually for this individual effect p.213	
Base Note	←		Selects the type of notes that specify the LFO speed p.213	
Times	←	x1...x32	Sets the number of notes that specify the LFO speed p.213	
Wet/Dry	←	-Wet...-1 : 99, Dry, 1 : 99...Wet	Sets the balance between the effect and the dry input p.216	
Src	Source	Off...Tempo	Selects a modulation source for Wet/Dry	
Amt	Amount	-100...+100	Sets the modulation amount for Wet/Dry	

Dmod Modulation

When the modulation source is used for control, this parameter reverses the left and right modulation direction.

LFO Dmod Sync

Source

L LFO Phase [deg]

R LFO Phase [deg]

If “LFO Sync” is On, the LFO will be reset by the modulation source that is received.

The “Source” parameter sets the modulation source that resets the LFO. For example, you can assign Gate as a modulation source so that the sweep always starts from the specified point.

“L LFO Phase” and “R LFO Phase” set the phase obtained when the left and right LFOs are reset. In this way, you can create changes in pitch sweep for the left and right channels individually.

The effect is off when a value of the modulation source specified in the “Source” parameter is 63 or smaller, and the effect is on when the value is 64 or higher. The LFO is triggered and reset to the “L LFO Phase” and “R LFO Phase” settings when the value changes from 63 or smaller to 64 or higher.

093: St. Dynamic Delay (Stereo Dynamic Delay)

This stereo delay controls the level of delay according to the input signal level. You can use this as a ducking delay that applies delay to the sound only when you play keys at a high velocity or only when the volume level is low.

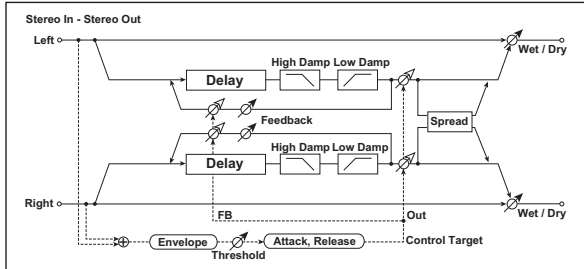

When “Polarity” is negative, the Control Target value equals the parameter value if the input level is below the threshold, or is obtained by multiplying the parameter value by the “Offset” value if the level exceeds the threshold. The “Attack” and “Release” parameters specify attack time and release time of delay level control.

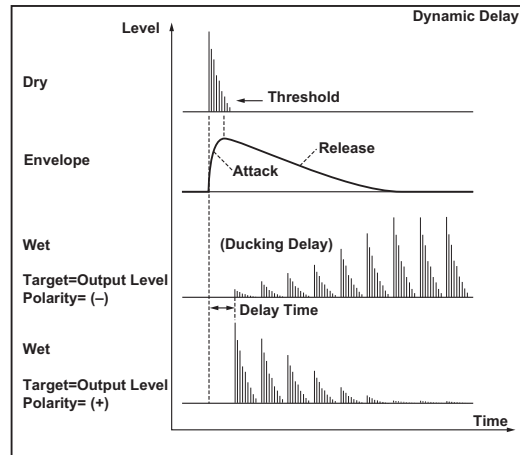

Parameter	Value	Explanation
Control Target	None, Out, FB (Feedback)	Selects from no control, output, and feedback p.258
Polarity	←, +, -	Reverses level control p.258
Threshold	←, 0...100	Sets the level where the effect is applied p.258
Offset	←, 0...100	Sets the offset of level control p.258
Attack	←, 1...100	Sets the attack time of level control p.258
Release	←, 1...100	Sets the release time of level control p.258
L Dly[ms]	L Delay Time [ms], 0.0...274.0	Sets the delay time for the left channel
R Dly[ms]	R Delay Time [ms], 0.0...274.0	Sets the delay time for the right channel
Feedback	←, -100...+100	Sets the feedback amount
Spread	←, -100...+100	Sets the width of the stereo image of the effect sound p.256
HiDamp[%]	High Damp [%], 0...100	Sets the damping amount in the high range p.256
LoDamp[%]	Low Damp [%], 0...100	Sets the damping amount in the low range p.256
Wet/Dry	←, Dry, 1 : 99...99 : 1, Wet	Sets the balance between the effect and the dry input
Src	Source, Off...Tempo	Selects a modulation source for Wet/Dry
Amt	Amount, -100...+100	Sets the modulation amount for Wet/Dry

Control Target

This parameter selects no level control, delay output control (effect balance), or feedback amount control.

- Polarity**
- Threshold**
- Offset**
- Attack**
- Release**

The “Offset” parameter specifies the value for the “Control Target” parameter (that is set to None), expressed as the ratio relative to the parameter value (the “Wet/Dry” value with “Control Target” = Output Level, or the “Feedback” value with “Control Target” = Feedback).

When “Polarity” is positive, the “Control Target” value is obtained by multiplying the parameter value by the “Offset” value (if the input level is below the threshold), or equals the parameter value if the input level exceeds the threshold.

094: St. Auto PanningDly (Stereo Auto Panning Delay)

This stereo delay effect pans the delay sound left and right using the LFO.

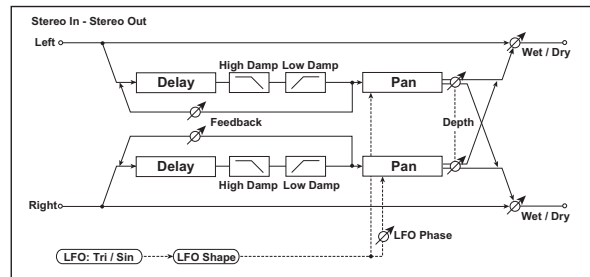

Parameter	Value	Explanation
L Dly[ms]	L Delay Delay Time [ms], 0.0...274.0	Sets the delay time for the left channel
L Feedback	L Feedback, -100...+100	Sets the feedback amount for the left channel
R Dly[ms]	R Delay Delay Time [ms], 0.0...274.0	Sets the delay time for the right channel
R Feedback	R Feedback, -100...+100	Sets the feedback amount for the right channel
HiDamp[%]	High Damp [%], 0...100	Sets the damping amount in the high range p.256
LoDamp[%]	Low Damp [%], 0...100	Sets the damping amount in the low range p.256
LFO	LFO Waveform, Tri (Triangle), Sine	Selects the LFO Waveform
Shape	LFO Shape, -100...+100	Changes the curvature of the LFO Waveform p.214
Phase	Phase [deg], -180...+180	Sets the LFO phase difference between the left and right p.229
Pan[Hz]	Panning Freq [Hz], 0.02...20.00	Sets the panning speed
Pan MIDI Sync	BPM/MIDI Sync, Off, On	Switches between using the frequency of the panning speed and using the tempo and notes

BPM	←	MIDI, 40.00... 300.00	MIDI syncs to the system tempo; 40–300 sets the tempo manually for this individual effect p.213	
Base Note	←		Selects the type of notes to specify the delay time for the panning speed p.213	
Times	←	x1...x32	Sets the number of notes to specify the delay time for the panning speed p.213	
Pan Depth	Pan Depth	0...100	Sets the panning width	
Src	Source	Off...Tempo	Selects the modulation source for the panning width	
Amt	Amount	-100...+100	Set the modulation amount of the panning width	
Wet/Dry	←	Dry, 1 : 99... 99 : 1, Wet	Sets the balance between the effect and the dry input	
Src	Source	Off...Tempo	Selects a modulation source for Wet/Dry	
Amt	Amount	-100...+100	Sets the modulation amount for Wet/Dry	

095: Tape Echo

This effect simulates a tape echo unit with three playback heads. The distortion and tonal change typical of magnetic tape are also reproduced.

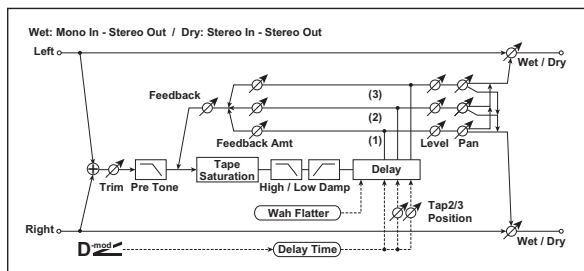

Parameter	Value	Explanation	
Tap1 [ms]	Tap1 Delay [ms] 0...539	Sets the delay time (tap1) p.259	
Src	Source	Off...Tempo	Selects the modulation source of the delay time p.259
Amt	Amount	-2700... +2700	Sets the modulation amount of delay time p.259
Tap2 [%]	Tap2 Position [%] 0...100	Sets the position of Tap 2 relative to the Tap 1 delay time the depth of pitch variation p.259	
Tap3 [%]	Tap3 Position [%] 0...100	Sets the position of Tap 3 relative to the Tap 1 delay time the depth of pitch variation p.259	
Feedback	Feedback Level 0...100	Sets the amount of feedback for Taps 1, 2, and 3 p.259	
Src	Source	Off...Tempo	Selects the modulation source of feedback amount
Amt	Amount	-100...+100	Sets the feedback amount
Saturation	←	0...100	Sets the distortion amount
HiDamp[%]	High Damp [%] 0...100	Sets the damping amount in the high range	
LoDamp[%]	Low Damp [%] 0...100	Sets the damping amount in the low range	

Tap1 Lvl	Tap1 Level	0...100	Sets the Tap1 output level	
Pan	←	L, 1...99, R	Sets the stereo image of tap1	
FB Amt	Feedback Amount	-100...+100	Sets the Tap1 feedback amount p.259	
Tap2 Lvl	Level	0...100	Sets the Tap2 output level	
Pan	←	L, 1...99, R	Sets the stereo image of tap2	
FB Amt	Feedback Amount	-100...+100	Sets the Tap2 feedback amount p.259	
Tap3 Lvl	Level	0...100	Sets the Tap3 output level	
Pan	←	L, 1...99, R	Sets the stereo image of tap3	
FB Amt	Feedback Amount	-100...+100	Sets the Tap3 feedback amount p.259	
Input Trim	←	0...100	Sets the input gain	
Pre Tone	←	0...100	Sets the tone of the input	
Wow [Hz]	Wow Flutter [Hz]	0.02...1.00	Sets the frequency where pitch variation will occur	
Wow Depth	Depth	0...100	Sets the depth of pitch variation	
Wet/Dry	←	Dry, 1 : 99...99 : 1, Wet	Sets the balance between the effect and the dry input	
Src	Source	Off...Tempo	Selects a modulation source for Wet/Dry	
Amt	Amount	-100...+100	Sets the modulation amount for Wet/Dry	

Tap1 Delay [ms]

Source

Amount

Tap2 Position [%]

Tap3 Position [%]

The delay time for Tap 2 and 3 is specified as a proportion (%) relative to “Delay (Tap1).” Even if you use dynamic modulation to control “Delay (Tap1),” Tap 2 and 3 will change at the same proportion.

Feedback Amount

Feedback Level

The feedback output from Tap 1, 2, and 3 is mixed according to the “Feedback Amount,” and then the final amount of feedback is specified by “Feedback Level.”

096: Echo Plus

This models a famous analog tape echo unit. On the original device, “echo” was created by a playback head, and the “delay time” was specified by adjusting the speed of the motor. The warmth and subtlety of the echoes it generated made this “lo-fi” unit a favorite with many pro musicians.

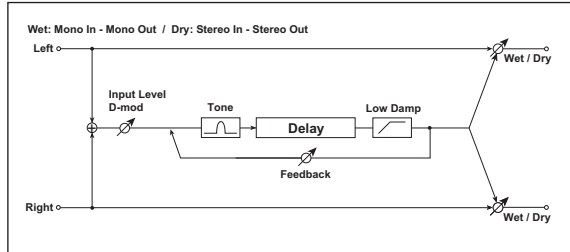

Parameter	Value	Explanation	
Time [ms]	← 0...539	Sets the delay time	
Feedback	← 0...100	Sets the amount of feedback	
Tone	← 1...100	Sets the tone of the delay sound	
LoDamp[%]	Low Damp [%] 0...100	Sets the damping amount in the low range p.256	
InLvl Dmod	Input Level Dmod [%] -100...+100	Sets the modulation amount of the input level p.250	D ^{mod}
Src	Input Level Mod Source Off...Tempo	Selects the modulation source for the input level p.250	
Wet/Dry	← Dry, 1 : 99... 99 : 1, Wet	Sets the balance between the effect and the dry input	D ^{mod}
Src	Source Off...Tempo	Selects a modulation source for Wet/Dry	
Amt	Amount -100...+100	Sets the modulation amount for Wet/Dry	

097: Auto Reverse

This effect records the input signal and automatically plays it in reverse (the effect is similar to a tape reverse sound).

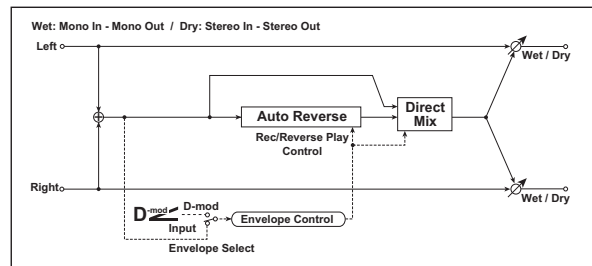

Parameter	Value	Explanation	
Rec Mode	← Single, Multi	Sets the recording mode p.260	
Reverse Time [ms]	← 20...2640	Sets the maximum duration of the reverse playback p.260	
Env Sel	Envelope Dmod, Input	Selects whether the start and end of recording is controlled via the modulation source or the input signal level p.261	
Src	Source Off...Tempo	Selects the modulation source that controls recording when Envelope Select is set to Dmod p.261	D ^{mod}
Threshold	← 0...100	Sets the recording start level when Envelope Select is set to Input p.261	
Response	← 0...100	Sets the speed of the response to the end of recording	
Direct Mix	← Always On, Always Off, Cross Fade	Selects how a dry sound is mixed p.261	
Wet/Dry	← Dry, 1 : 99... 99 : 1, Wet	Sets the balance between the effect and the dry input	D ^{mod}
Src	Source Off...Tempo	Selects a modulation source for Wet/Dry	
Amt	Amount -100...+100	Sets the modulation amount for Wet/Dry	

Rec Mode

Reverse Time [ms]

When “Rec Mode” is set to Single, you can set up to 2,640 msec for “Reverse Time.” If recording starts during the reverse playback, the playback will be interrupted.

When “Rec Mode” is set to Multi, you can make another recording during the reverse playback. However, the maximum Reverse Time is limited to 1,320 msec.

If you wish to record a phrase or rhythm pattern, set “Rec Mode” to Single. If you record only one note, set “Rec Mode” to Multi. The “Reverse Time” parameter specifies the maximum duration of the reverse playback. The part in excess of this limit will not be played in reverse. If you wish to add short pieces of the reverse playback of single notes, make the “Reverse Time” shorter.

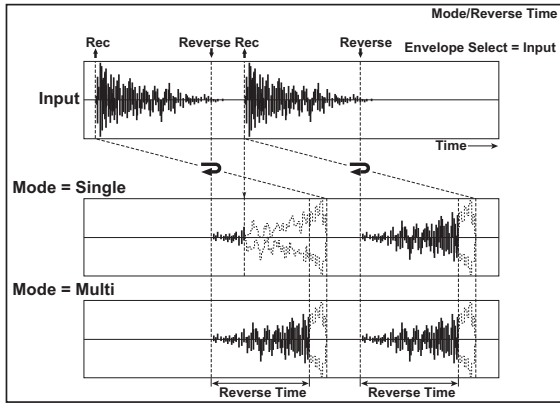

Envelope Source Threshold

These parameters select the source to control the start and end of recording. When “Envelope” is set to Dmod, the input signal will be recorded only when the value of the modulation source selected by the Source parameter is 64 or higher. When “Envelope” is set to Input, the input signal will be recorded only when its level exceeds the Threshold level. When recording is completed, reverse playback starts immediately.

Direct Mix

With Always On, a dry sound is usually output. With Always Off, dry sounds are not output. With Cross Fade, a dry sound is usually output. Set Wet/Dry to Wet to use this parameter effectively.

098: Sequence BPM Dly (Sequence BPM Delay)

This four-tap delay enables you to select a tempo and rhythm pattern to set up each tap.

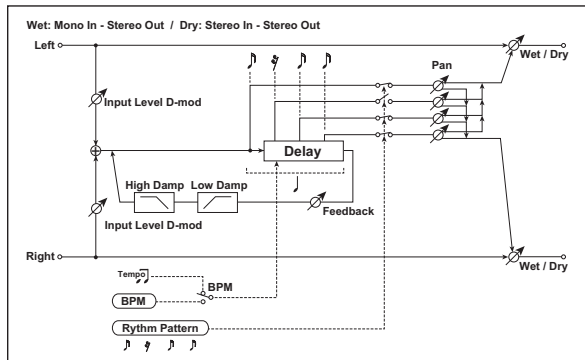

Paramter	Value	Explanation
BPM	MIDI, 40.00... 300.00	MIDI syncs to the system tempo; 40–300 sets the tempo manually for this individual effect p.261
Rhythm	Rhythm Pattern	Selects a rhythm pattern p.261
Tap1 Pan	L, 1...99, R	Sets the panning of Tap1
Tap2	Tap2 Pan	Sets the panning of Tap2
Tap3	Tap3 Pan	Sets the panning of Tap3
Tap4	Tap4 Pan	Sets the panning of Tap4

Feedback	←	-100...+100	Sets the feedback amount	D-mod
Src	Source	Off...Tempo	Selects the modulation source of feedback amount	
Amt	Amount	-100...+100	Sets the feedback amount	
HiDamp[%]	High Damp [%]	0...100	Sets the damping amount in the high range p.256	
LoDamp[%]	Low Damp [%]	0...100	Sets the damping amount in the low range p.256	
InLvl Dmod	Input Level Dmod [%]	-100...+100	Sets the modulation amount of the input level p.250	D-mod
Src	Source	Off...Tempo	Selects the modulation source for the input level p.250	
Wet/Dry	←	Dry, 1 : 99... 99 : 1, Wet	Sets the balance between the effect and the dry input	D-mod
Src	Source	Off...Tempo	Selects a modulation source for Wet/Dry	
Amt	Amount	-100...+100	Sets the modulation amount for Wet/Dry	

BPM Rhythm

With the tempo specified by the “BPM” parameter (or the MIDI Clock tempo if “BPM” is set to MIDI), the length of one beat equals the feedback delay time, and the interval between taps becomes equal. Selecting a rhythm pattern will automatically turn the tap outputs on and off. When “BPM” is set to MIDI, the lower limit of the “BPM” is 44.

099: L/C/R BPM Delay

The L/C/R delay enables you to match the delay time with the song tempo. You can also synchronize the delay time with the arpeggiator or sequencer. If you program the tempo before performance, you can achieve a delay effect that synchronizes with the song in real-time. Delay time is set by notes.

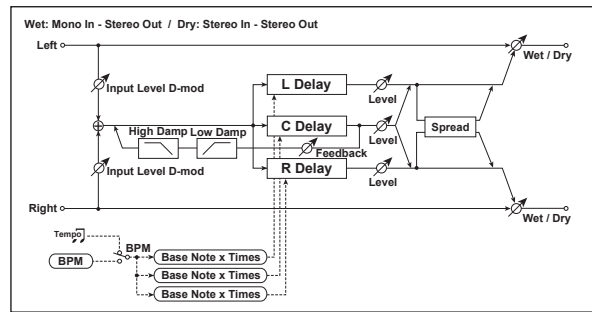

Paramter	Value	Explanation
BPM	←	MIDI, 40.00... 300.00 MIDI syncs to the system tempo; 40–300 sets the tempo manually for this individual effect p.213
Time Over?	←	---, OVER! Displays an error message when the delay time exceeds the upper limit p.262
L Dly Note	L Delay Base Note	Selects the type of notes to specify the delay time for TapL p.262
L Times	Times	x1...x32 Sets the number of notes to specify the delay time for TapL p.262
L Level	Level	0...50 Sets the output level of TapL

C Dly Note	C Delay Base Note		Selects the type of notes to specify the delay time for TapC p.262	
C Times	Times	x1...x32	Sets the number of notes to specify the delay time for TapC p.262	
C Level	Level	0...50	Sets the output level of TapC	
R Dly Note	R Delay Base Note		Selects the type of notes to specify the delay time for TapR p.262	
R Times	Times	x1...x32	Sets the number of notes to specify the delay time for TapR p.262	
R Level	Level	0...50	Sets the output level of TapR	
Feedback C	C Delay Feedback	-100...+100	Sets the feedback amount of TapC	
Src	Source	Off...Tempo	Selects the modulation source for the TapC feedback	
Amt	Amount	-100...+100	Sets the modulation amount of the TapC feedback	
HiDamp[%]	High Damp [%]	0...100	Sets the damping amount in the high range p.256	
LoDamp[%]	Low Damp [%]	0...100	Sets the damping amount in the low range p.256	
InLvl Dmod	Input Level Dmod [%]	-100...+100	Sets the modulation amount of the input level p.250	
Src	Source	Off...Tempo	Selects the modulation source for the input level p.250	
Spread		←	Sets the width of the stereo image of the effect sound p.256	
Wet/Dry		←	Sets the balance between the effect and the dry input	
Src	Source	Off...Tempo	Selects a modulation source for Wet/Dry	
Amt	Amount	-100...+100	Sets the modulation amount for Wet/Dry	

BPM

Delay Base Note

Times

The delay time is the duration of Times number of Delay Base Note note values at the BPM tempo (or if BPM is set to MIDI, the tempo determined by MIDI Clock).

Time Over?

You can set the delay time up to 5,460 msec. If the delay time exceeds this limit, the error message “OVER!” appears in the display. Set the delay time parameters so that this message will not appear. “Time Over?” is only a display parameter.

100: Stereo BPM Delay

This stereo delay enables you to set the delay time to match the song tempo.

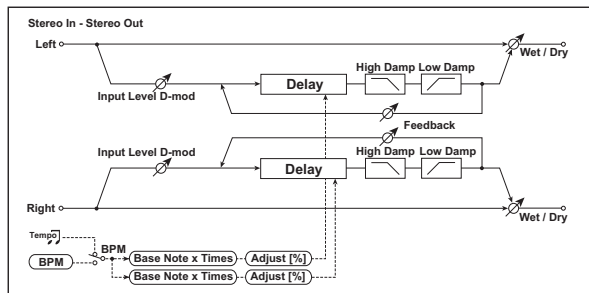

Parameter	Value	Explanation	
BPM	←	MIDI, 40.00... 300.00	MIDI syncs to the system tempo; 40–300 sets the tempo manually for this individual effect p.262
Time OverL?	L Delay Time Over?	---, OVER!	Display the error message if the left channel delay time exceeds the upper limit p.263
Time OverR?	R Delay Time Over?	---, OVER!	Display the error message if the right channel delay time exceeds the upper limit p.263
L Dly Note	Base Note		Selects the type of notes to specify the left channel delay time p.262
Time	←	x1...x32	Sets the number of notes to specify the left channel delay time p.262
Adj[%]	Adjust [%]	-2.50...+2.50	Fine-adjust the left channel delay time
R Dly Note	Base Note		Selects the type of notes to specify the right channel delay time p.262
R Time	Times	x1...x32	Sets the number of notes to specify the right channel delay time p.262
Adj[%]	Adjust [%]	-2.50...+2.50	Fine-adjust the right channel delay time
L Feedback	←	-100...+100	Sets the feedback amount for the left channel
Src	Source	Off...Tempo	Selects the modulation source of feedback amount
Amt	Amount	-100...+100	Sets the modulation amount of the left channel feedback
R Feedback	←	-100...+100	Sets the feedback amount for the right channel
Amt	Amount	-100...+100	Sets the modulation amount of the right channel feedback
HiDamp[%]	High Damp [%]	0...100	Sets the damping amount in the high range p.256
LoDamp[%]	Low Damp [%]	0...100	Sets the damping amount in the low range p.256
InLvl Dmod	Input Level Dmod [%]	-100...+100	Sets the modulation amount of the input level p.250
Src	Source	Off...Tempo	Selects the modulation source for the input level p.250
Wet/Dry	←	Dry, 1 : 99... 99 : 1, Wet	Sets the balance between the effect and the dry input
Src	Source	Off...Tempo	Selects a modulation source for Wet/Dry

Amt	Amount	-100...+100	Sets the modulation amount for Wet/Dry	
-----	--------	-------------	--	--

Time Over? L, R

You can set the delay time up to 2,730 msec. If the delay time exceeds this limit, the error message “OVER!” appears in the display. Set the delay time parameters so that this message will not appear. “Time Over?” is only a display parameter.

101: St.BPM Mtap Delay (Stereo BPM Multitap Delay)

This is a stereo multi-tapped delay that lets you set the delay time to match the tempo of the song.

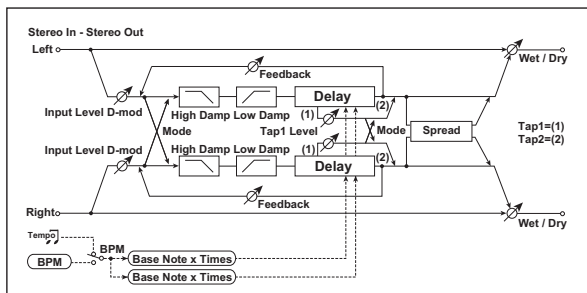

InpLvl Dmod	Input Level Dmod [%]	-100...+100	Sets the modulation amount of the input level p.250	D-mod
Src	Source	Off...Tempo	Selects the modulation source for the input level p.250	
Spread	←	-100...+100	Sets the width of the stereo image of the effect sound p.256	D-mod
Src	Source	Off...Tempo	Selects the modulation source of the effect sound's stereo image width	
Amt	Amount	-100...+100	Sets the modulation amount of the effect sound's stereo image width	
Wet/Dry	←	Dry, 1 : 99... 99 : 1, Wet	Sets the balance between the effect and the dry input	D-mod
Src	Source	Off...Tempo	Selects a modulation source for Wet/Dry	
Amt	Amount	-100...+100	Sets the modulation amount for Wet/Dry	

Parameter	Value	Explanation		
Mode	←	Normal, Cross Feedback, Cross Pan1, Cross Pan2 p.256		
BPM	←	MIDI, 40.00...300.00	A-Sync	
T.Over 1?	Tap1 Delay Time Over?	---, OVER!		
T.Over 2?	Tap2 Delay Time Over?	---, OVER!		
T1 Dly Note	Tap1 Base Note	3	Selects the type of notes to specify the delay time for Tap1 p.262	
T1 Times	Tap1 Times	x1...x32	Sets the number of notes to specify the delay time for Tap1 p.262	
T1 Lvl	Tap1 Level	0...100	Sets the Tap1 output level p.257	
T2 Dly Note	Tap2 Base Note	3	Selects the type of notes to specify the delay time for Tap2 p.262	
T2 Times	Tap2 Times	x1...x8	Sets the number of notes to specify the delay time for Tap2 p.262	
Fback(T2)	Feedback (Tap2)	-100...+100	Sets the Tap2 feedback amount	D-mod
Src	Source	Off...Tempo	Selects the modulation source of the Tap2 feedback amount	
Amt	Amount	-100...+100	Sets the modulation amount of the Tap2 feedback amount	
HiDamp[%]	High Damp [%]	0...100	Sets the damping amount in the high range p.256	
LoDamp[%]	Low Damp [%]	0...100	Sets the damping amount in the low range p.256	

102: St. BPM Mod. Delay (Stereo BPM Modulation Delay)

This is a stereo modulation delay that lets you synchronize the delay time to the tempo of the song.

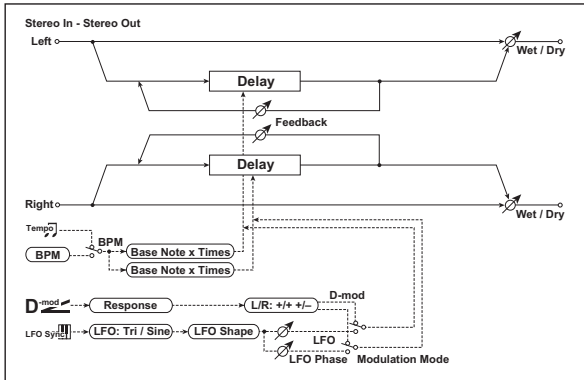

Parameter	Value	Explanation	
BITIM	Delay BPM	MIDI, 40.00...300.00	MIDI syncs to the system tempo; 40–300 sets the tempo manually for this individual effect p.262
T.OverL?	L Delay Time Over?	---, OVER!	Display the error message if the left channel delay time exceeds the upper limit p.264
T.OverR?	R Delay Time Over?	---, OVER!	Display the error message if the right channel delay time exceeds the upper limit p.264
L Dly Note	Base Note	♪...♪ ₃	Selects the type of notes to specify the left channel delay time p.262
Times	L Times	x1...x32	Sets the number of notes to specify the left channel delay time p.262
Feedbck	L Feedback	-100...+100	Sets the feedback amount of left delay
R Dly Note	R Delay Base Note	♪...♪ ₃	Selects the type of notes to specify the right channel delay time p.262
Times	R Times	x1...x32	Sets the number of notes to specify the right channel delay time p.262
Feedbck	R Feedback	-100...+100	Sets the feedback amount of right delay
L Depth	←	0...200	Sets the depth of the left LFO modulation
LFO Phase [deg]	←	-180...+180	Sets the phase obtained when the left LFO is reset p.257
R Depth	←	0...200	Sets the depth of the right LFO modulation
R LFO Phase [deg]	←	-180...+180	Sets the phase obtained when the right LFO is reset p.257
Mode Mode	Modulation Mode	LFO, Dmod	Switches between LFO modulation control and modulation source control
Dmod Mod	Dmod Modulation	L/R: +/+ , L/R: +/-	Reversed L/R control by modulation source p.257
Src	Source	Off...Tempo	Selects the modulation source that controls delay time
Resp	Response	0...30	Sets the rate of response to the modulation source

LFO	LFO Waveform	Tri (Triangle), Sine	Selects the LFO Waveform	
LFO Shape	←	-100...+100	Changes the curvature of the LFO Waveform p.214	
LFO [Hz]	LFO Freq [Hz]	0.02...20.00	Sets the speed of the LFO p.216	
Sync	LFO Dmod Sync	Off, On	Switches LFO reset off/on p.257	
Src	Source	Off...Tempo	Selects the modulation source that resets the LFO	D ^{mod}
MIDI Sync	BPM/MIDI Sync	Off, On	When this is on, the LFO speed is set by BPM, Base Note, and Times, instead of Frequency p.213	aj ^{sync}
BPM	←	MIDI, 40.00...300.00	MIDI syncs to the system tempo; 40–300 sets the tempo manually for this individual effect p.213	
Base Note	←	♪...♪ ₃	Selects the type of notes that specify the LFO speed p.213	
Times	←	x1...x32	Sets the number of notes that specify the LFO speed p.213	
Wet/Dry	←	-Wet...-99 : 1, Dry, 99 : 1...Wet	Sets the balance between the effect and the dry input p.216	D ^{mod}
Src	Source	Off...Tempo	Selects a modulation source for Wet/Dry	
Amt	Amount	-100...+100	Sets the modulation amount for Wet/Dry	

Time Over? L, R







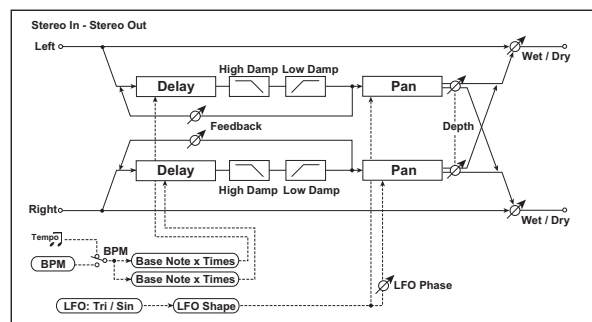

You can set the delay time up to 2,550 msec. If the delay time exceeds this limit, the error message “OVER!” appears in the display. Set the delay time parameters so that this message will not appear. “Time Over?” is only a display parameter.

103: St.BPMAutoPanDly (Stereo BPM Auto Panning Delay)

This stereo auto panning delay enables you to set the delay time to match the song tempo.











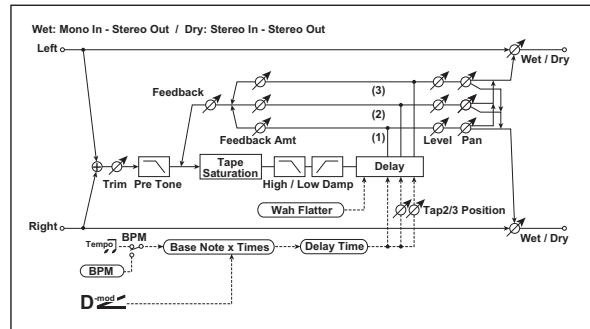

Parameter	Value	Explanation	
BITIM	Delay BPM	MIDI, 40.00...300.00	MIDI syncs to the system tempo; 40–300 sets the tempo manually for this individual effect p.262
TimeOverL?	L Delay Time Over?	---, OVER!	Display the error message if the left channel delay time exceeds the upper limit p.263
TimeOverR?	R Delay Time Over?	---, OVER!	Display the error message if the right channel delay time exceeds the upper limit p.263

L Dly Note	Base Note		Selects the type of notes to specify the left channel delay time p.262	
Times	L Times	x1...x32	Sets the number of notes to specify the left channel delay time p.262	
Feedbck	LFeedback	-100...+100	Sets the feedback amount for the left channel	
R Dly Note	Base Note		Selects the type of notes to specify the right channel delay time p.262	
Times	R Times	x1...x32	Sets the number of notes to specify the right channel delay time p.262	
Feedbck	R Feedback	-100...+100	Sets the feedback amount for the right channel	
Hi Damp[%]	High Damp [%]	0...100	Sets the damping amount in the high range p.256	
Lo Damp[%]	Low Damp [%]	0...100	Sets the damping amount in the low range p.256	
LFO	LFO Waveform	Tri (Triangle), Sine	Selects the LFO Waveform	
Shape	LFO Shape	-100...+100	Changes the curvature of the LFO Waveform p.214	
Phase	Phase [deg]	-180...+180	Sets the LFO phase difference between the left and right p.228	
Pan [Hz]	PanningFreq [Hz]	0.02...20.00	Sets the panning speed p.213	
Pan MDI Sync	Panning BPM/MIDI Sync	Off, On	When this is on, the pan LFO speed is set by BPM, Base Note, and Times, instead of Frequency p.213	
BPM	←	MIDI, 40.00... 300.00	MIDI syncs to the system tempo; 40-300 sets the tempo manually for this individual effect p.213	
Base Note	←		Selects the type of notes to specify the delay time for the panning speed p.213	
Times	←	x1...x32	Sets the number of notes to specify the delay time for the panning speed p.213	
Pan Dept	h	0...100	Sets the panning width	
Src	Source	Off...Tempo	Selects the modulation source for the panning width	
Amt	Amount	-100...+100	Set the modulation amount of the panning width	
Wet/Dry	←	Dry, 1 : 99... 99 : 1, Wet	Sets the balance between the effect and the dry input	
Src	Source	Off...Tempo	Selects a modulation source for Wet/Dry	
Amt	Amount	-100...+100	Sets the modulation amount for Wet/Dry	

104: Tape Echo BPM

This is a tape echo that lets you synchronize the delay time to the tempo of the song.



Parameter	Value	Explanation		
BPM	Delay BPM	MIDI, 40.00... 300.00	MIDI syncs to the system tempo; 40-300 sets the tempo manually for this individual effect p.262	
Tap1 Dmod Src	Tap1 Dmod Source	Off...Tempo	Selects the modulation source of the delay time p.266	
Ta1 Note	Tap1 Delay Note		Selects the type of notes to specify the delay time (tap1) p.262, p.266	 
Times	Tap1 Times	x1...x32	Sets the number of notes to specify the delay time (tap1) p.262, p.266	
Time Over?	←	---, OVER!	Displays an error message when the delay time exceeds the upper limit p.266	
Tap1 Dmod	Dmod Max Note		Selects the note value used to specify the delay time when the modulation is at maximum p.266	 
Times	←	x1...x32	Specifies the number of notes used to specify the delay time when the modulation is at maximum p.266	
Tap2 [%]	Tap2 Position [%]	0...100	Sets the position of Tap 2 relative to the Tap 1 delay time the depth of pitch variation p.259	
Tap3 [%]	Tap3 Position [%]	0...100	Sets the position of Tap 3 relative to the Tap 1 delay time the depth of pitch variation p.259	
Feedback	Feedback Level	0...100	Sets the amount of feedback for Taps 1, 2, and 3 p.259	
Src	Source	Off...Tempo	Selects the modulation source of feedback amount	
Amt	Amount	-100...+100	Sets the depth by which feedback amount will be modulated	
Saturation	←	0...100	Sets the distortion amount	
Hi Damp[%]	High Damp [%]	0...100	Sets the damping amount in the high range	
Lo Damp[%]	Low Damp [%]	0...100	Sets the damping amount in the low range	
Tap1 Lvl	Tap1 Level	0...100	Sets the Tap1 output level	
Pan	←	L, 1...99, R	Sets the stereo image of tap1	
FB Amt	Feedback Amount	-100...+100	Sets the Tap1 feedback amount p.259	
Tap2 Lvl	Level	0...100	Sets the Tap2 output level	

Pan	←	L, 1...99, R	Sets the stereo image of tap2
FB Amt	Feedback Amount	-100...+100	Sets the Tap2 feedback amount p.259
Tap3 Lvl	Tap3 Level	0...100	Sets the Tap3 output level
Pan	←	L, 1...99, R	Sets the stereo image of tap3
FB Amt	Feedback Amount	-100...+100	Sets the Tap3 feedback amount p.259
Input Trim	←	0...100	Sets the input gain
Pre Tone	←	0...100	Sets the tone of the input
Wow [Hz]	Wow Flutter [Hz]	0.02...1.00	Sets the frequency-where pitch variation will occur
Wow Depth	←	0...100	Sets the depth of pitch variation
Wet/Dry	←	Dry, 1 : 99... 99 : 1, Wet	Sets the balance between the effect and the dry input 
Src	Source	Off...Tempo	Selects a modulation source for Wet/Dry
Amt	Amount	-100...+100	Sets the modulation amount for Wet/Dry

Tap1 Delay Note

Times

Source

Tap1 Dmod Note

Times

If “Source” is Off or the selected modulation is at 0, the delay time will be the length specified by “Tap1 Delay Note” and “Times.” If “Source” is other than Off, the delay time will change so that it will be as specified by “Tap1 Dmod Note” and “Times” when the maximum modulation is reached.

Time Over?

You can set the delay time up to 539msec. If the delay time exceeds this limit, the error message “OVER!” appears in the display. Set the delay time parameters so that this message will not appear. “Time Over?” is only a display parameter.

105: Reverb Hall

This hall-type reverb simulates the reverberation of mid-size concert halls or ensemble halls.

106: Reverb Plate

This plate reverb simulates warm (dense) reverberation.

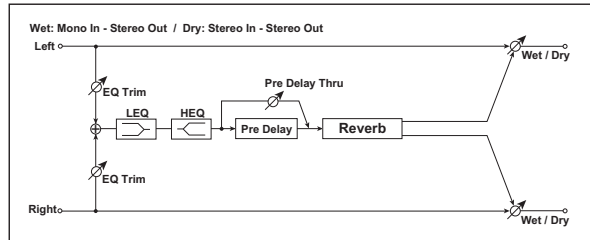

Parameter	Value	Explanation	
Times[s]	Reverb Time [s]	0.1...10.0	Sets the reverberation time
HiDamp[%]	High Damp [%]	0...100	Sets the damping amount in the high range
PreEQ Trim	Pre EQ Trim	0...100	Sets the EQ input level
PreDlyThru	Pre Delay Thru [%]	0...100	Sets the mix ratio of non-delay sound
Pre LEQ Fc	Low EQ Frequency	Low, Mid-Low	Selects the cutoff frequency (low or mid-low) of the low-range equalizer
Pre HEQ Fc	High EQ Frequency	High, Mid-High	Selects the cutoff frequency (high or mid-high) of the high-range equalizer
LEQ [dB]	Low EQ Gain [dB]	-15.0...+15.0	Sets the gain of Low EQ
HEQ [dB]	High EQ Gain [dB]	-15.0...+15.0	Sets the gain of High EQ
Wet/Dry	←	Dry, 1 : 99... 99 : 1, Wet	Sets the balance between the effect and the dry input 
Src	Source	Off...Tempo	Selects a modulation source for Wet/Dry
Amt	Amount	-100...+100	Sets the modulation amount for Wet/Dry

Pre Delay Thru [%]

“Pre Delay Thru” lets you accentuate the attack by mixing in sound that does not pass through the delay.

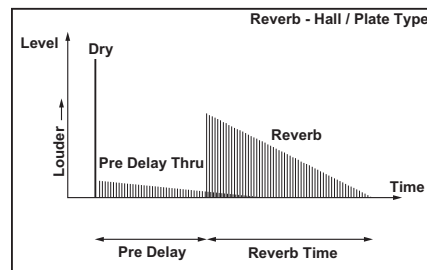

107: Reverb Room

This room-type reverb emphasizes the early reflections that make the sound tighter. Changing the balance between the early reflections and reverb sound allows you to simulate nuances, such as the type of walls of a room.

108: ReverbBrightRoom

This room-type reverb emphasizes the early reflections that make the sound brighter.

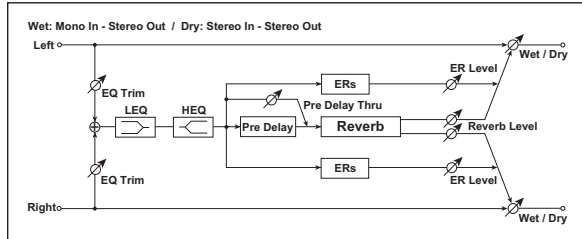

Parameter	Value	Explanation
Times [s]	Reverb Time [sec] 0.1...3.0	Sets the reverberation time
HiDamp[%]	High Damp [%] 0...100	Sets the damping amount in the high range
PreDl[ms]	Pre Delay [msec] 0...200	Sets the delay time from the dry sound p.267
preDlyThru	Pre Delay Thru [%] 0...100	Sets the mix ratio of non-delay sound p.267
ER Level	← 0...100	Sets the level of early reflections p.267
Rev. Level	Reverb Level 0...100	Sets the reverberation level p.267
PreEQ Trim	Pre EQ Trim 0...100	Sets the EQ input level
Pre LEQ Fc	Low EQ Frequency Low, Mid-Low	Selects the cutoff frequency (low or mid-low) of the low-range equalizer
Pre HEQ Fc	High EQ Frequency High, Mid-High	Selects the cutoff frequency (high or mid-high) of the high-range equalizer
LEQ [dB]	Low EQ Gain [dB] -15.0...+15.0	Sets the gain of Low EQ
HEQ [dB]	High EQ Gain [dB] -15.0...+15.0	Sets the gain of High EQ
Wet/Dry	← Dry, 1 : 99... 99 : 1, Wet	Sets the balance between the effect and the dry input D^{mod}
Src	Source Off...Tempo	Selects a modulation source for Wet/Dry
Amt	Amount -100...+100	Sets the modulation amount for Wet/Dry

Pre Delay

Pre Delay Thru [%]

“Pre Delay” specifies the delay time for the sound that is input to the reverb. This controls the spaciousness.

“Pre Delay Thru” lets you accentuate the attack by mixing in sound that does not pass through this delay.

ER Level

Reverb Level

These parameters set the early reflection level and reverb level. Changing these parameter values will allow you to simulate the type of walls in the room. That is, a larger “ER Level” simulates a hard wall, and a larger “Reverb Level” simulates a soft wall.

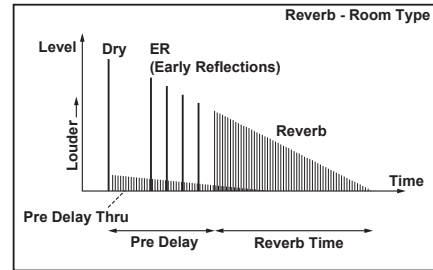

109: Reverb2 Spring

The R2-type reverbs R2.Spring–R2.Room have a different sonic character than Rev.Hall–Rev.Room2. They model the spring reverb systems that are built into some amps.

110: Reverb2 Hall

This models the reverberation of a concert hall that includes numerous echo components.

111: Reverb2 Plate

This models a type of reverb unit that vibrates a metal plate rather than springs. The reverb time is relatively short. Because the reverberation has a fast attack, it is suitable for percussive playing.

112: Reverb2 Room

This models the reverberation of a typical room that includes numerous early reflections.

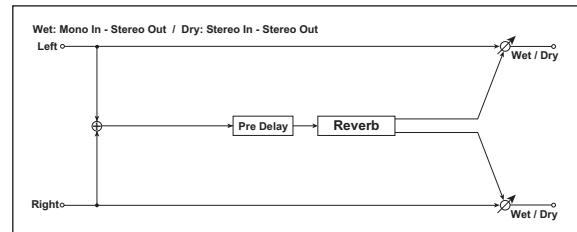

Parameter	Value	Explanation
Time [s]	← 0...100	Sets the reverberation time p.267
HiDamp[%]	High Damp [%] 0...100	Sets the damping amount in the high range
LoDamp[%]	Low Damp [%] 0...100	Sets the damping amount in the low range
PreDly [ms]	Pre Delay [msec] 0...200	Sets the delay time from the dry sound p.267
Wet/Dry	← Dry, 1 : 99... 99 : 1, Wet	Sets the balance between the effect and the dry input D^{mod}
Src	Source Off...Tempo	Selects a modulation source for Wet/Dry
Amt	Amount -100...+100	Sets the modulation amount for Wet/Dry

Time

In these reverbs, “Time” is not expressed in seconds, but instead is a value from 1 to 100. A value of 1 produces the shortest reverb, and 100 provides the longest reverb.

113: Early Reflections

This effect is only the early reflection part of a reverberation sound, and adds presence to the sound. You can select one of the four decay curves.

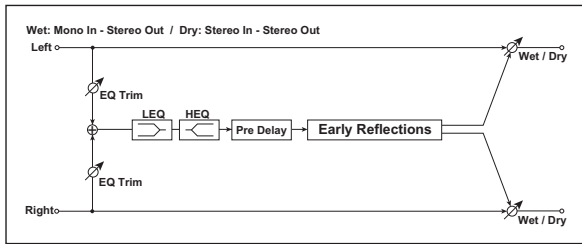

Parameter	Value	Explanation
Type	←	Sharp, Loose, Modulated, Reverse Selects the decay curve for the early reflection p.268
Times[ms]	ER Time [ms]	10...420 Sets the time length of early reflection
PreDl[ms]	Pre Delay [ms]	0...100 Sets the time taken from the original sound to the first early reflection
PreEQ Trim	Pre EQ Trim	0...100 Sets the input level of EQ applied to the effect sound
Pre LEQ Fc	Low EQ Frequency	Low, Mid-Low Selects the cutoff frequency (low or mid-low) of the low-range equalizer
Pre HEQ Fc	High EQ Frequency	High, Mid-High Selects the cutoff frequency (high or mid-high) of the high-range equalizer
LEQ [dB]	Low EQ Gain [dB]	-15.0...+15.0 Sets the gain of the Low EQ
HEQ [dB]	High EQ Gain [dB]	-15.0...+15.0 Sets the gain of the High EQ
Wet/Dry	←	Dry, 1 : 99... 99 : 1, Wet Sets the balance between the effect and the dry input
Src	Source	Off...Tempo Selects a modulation source for Wet/Dry
Amt	Amount	-100...+100 Sets the modulation amount for Wet/Dry

Type

This parameter selects the decay curve for the early reflection.

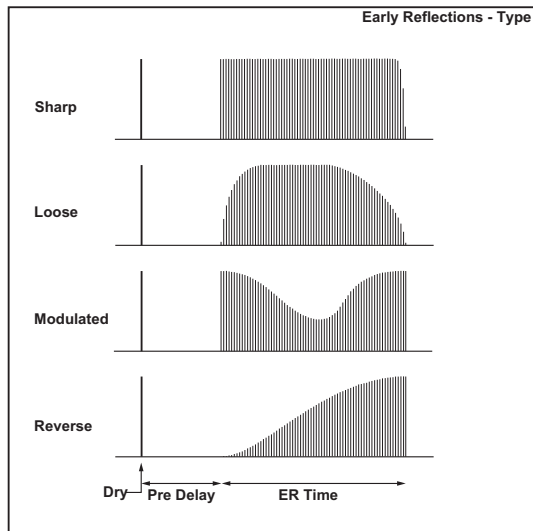

114: P4EQ - Mt.Delay (Parametric 4-Band EQ - Multitap Delay)

This effect combines a mono four-band parametric equalizer and a multitap delay.

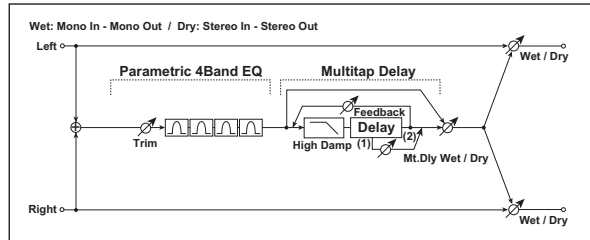

Parameter	Value	Explanation
Parametric 4-Band EQ		
E Trim	Trim	0...100 Sets the parametric EQ input level
E1 F[Hz]	Band1 Cutoff [Hz]	20...1.00k Sets the center frequency of Band 1
Q	Band1 Q	0.5...10.0 Sets the bandwidth of Band 1 p.211
G[dB]	Band1 Gain [dB]	-18...+18 Sets the gain of Band 1
E2 F[Hz]	Band2 Cutoff [Hz]	50...5.00k Sets the center frequency of Band 2
Q	Band2 Q	0.5...10.0 Sets the bandwidth of Band 2 p.211
G[dB]	Band2 Gain [dB]	-18...+18 Sets the gain of Band 2
E3 F[Hz]	Band3 Cutoff [Hz]	300...10.00k Sets the center frequency of Band 3
Q	Band3 Q	0.5...10.0 Sets the bandwidth of Band 3 p.211
G[dB]	Band3 Gain [dB]	-18...+18 Sets the gain of Band 3
E4 F[Hz]	Band4 Cutoff [Hz]	500...20.00k Sets the center frequency of Band 4
Q	Band4 Q	0.5...10.0 Sets the bandwidth of Band 4 p.211
G[dB]	Band4 Gain [dB]	-18...+18 Sets the gain of Band 4
Multitap Delay		
D T1[ms]	Tap1 Time [ms]	0.0...549.0 Sets the Tap1 delay time
Tap1 Level	←	0...100 Sets the Tap1 output level p.257
D T2 [ms]	Tap2 Time [ms]	0.0...549.0 Sets the Tap2 delay time
Fback(T2)	Feedback (Tap2)	-100...+100 Sets the Tap2 feedback amount
HiDamp [%]	High Damp [%]	0...100 Sets the damping amount in the high range
D W/D	[Dly]Wet/Dry	Dry, 1 : 99... 99 : 1, Wet Sets the multitap delay effect balance
Src	[Dly]Source	Off...Tempo Selects the Wet/Dry modulation source for the multitap delay
Amt	[Dly]Amount	-100...+100 Sets the Wet/Dry modulation amount for the multitap delay
Wet/Dry	←	Dry, 1 : 99... 99 : 1, Wet Sets the balance between the effect and the dry input
Src	Source	Off...Tempo Selects a modulation source for Wet/Dry
Amt	Amount	-100...+100 Sets the modulation amount for Wet/Dry

115: Comp - Mt.Delay (Compressor - Multitap Delay)

This effect combines a mono compressor and a multitap delay. You can change the order of the effects.

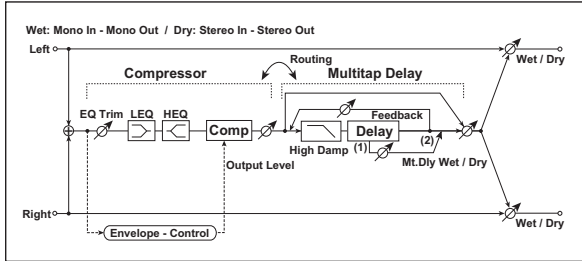

Parameter	Value	Explanation	
Compressor			
C Sens	Sensitivity	1...100	Sets the sensitivity p.207
C Attack	Attack	1...100	Sets the attack level p.207
Level	Out Level	0...100	Sets the compressor output level p.207
C EQ Trim	Pre EQ Trim	0...100	Sets the EQ input level
C LEQ	Low EQ Gain [dB]	-15...+15	Sets the gain of Low EQ
C HEQ	High EQ Gain [dB]	-15...+15	Sets the gain of High EQ
Multitap Delay			
DT1 [ms]	Tap1 Time [ms]	0.0...548.0	Sets the Tap1 delay time
Tap1 Level	←	0...100	Sets the Tap1 output level p.257
D T2 [ms]	Tap2 Time [ms]	0.0...548.0	Sets the Tap2 delay time
Fback(T2)	Feedback (Tap2)	-100...+100	Sets the Tap2 feedback amount
HiDamp [%]	High Damp [%]	0...100	Sets the damping amount in the high range p.256
D W/D	[Dly]Wet/Dry	Dry, 1 : 99...99 : 1, Wet	Sets the multitap delay effect balance D^{mod}
Src	[Dly]Source	Off...Tempo	Selects the Wet/Dry modulation source for the multitap delay
Amt	[Dly]Amount	-100...+100	Sets the Wet/Dry modulation amount for the multitap delay
Routing	←	Comp → Delay, Delay → Comp	Switches the order of the compressor and multitap delay
Wet/Dry	←	Dry, 1 : 99...99 : 1, Wet	Sets the balance between the effect and the dry input D^{mod}
Src	Source	Off...Tempo	Selects a modulation source for Wet/Dry
Amt	Amount	-100...+100	Sets the modulation amount for Wet/Dry

116: Limiter - Mt.Delay (Limiter - Multitap Delay)

This effect combines a mono limiter and a multitap delay. You can change the order of the effects.

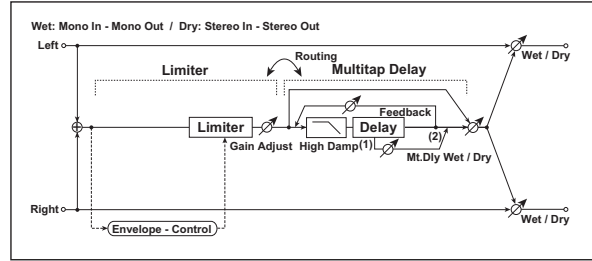

Parameter	Value	Explanation	
Limiter			
L Ratio	Ratio	1.0 : 1...50.0 : 1, Inf : 1	Sets the signal compression ratio p.208
Thrsh [dB]	Threshold [dB]	-40...0	Sets the level above which the compressor is applied p.208
L Attack	Attack	1...100	Sets the attack time
Release	←	1...100	Sets the release time
L Gain [dB]	Gain Adjust [dB]	-Inf, -38...+24	Sets the limiter output gain p.208
Multitap Delay			
D T1 [ms]	Tap1 Time [ms]	0.0...1360.0	Sets the Tap1 delay time
Tap1 Level	←	0...100	Sets the Tap1 output level p.257
D T2 [ms]	Tap2 Time [ms]	0.0...1360.0	Sets the Tap2 delay time
F.back(T2)	Feedback (Tap2)	-100...+100	Sets the Tap2 feedback amount
HiDamp [%]	High Damp [%]	0...100	Sets the damping amount in the high range p.256
D W/D	[Dly]Wet/Dry	Dry, 1 : 99...99 : 1, Wet	Sets the multitap delay effect balance D^{mod}
Src	[Dly]Source	Off...Tempo	Selects the multitap delay's Wet/Dry modulation source
Amt	[Dly]Amount	-100...+100	Sets the multitap delay's Wet/Dry modulation amount
Routing	←	Limiter → Delay, Delay → Limiter	Switches the order of the limiter and multitap delay
Wet/Dry	←	Dry, 1 : 99...99 : 1, Wet	Sets the balance between the effect and the dry input D^{mod}
Src	Source	Off...Tempo	Selects a modulation source for Wet/Dry
Amt	Amount	-100...+100	Sets the modulation amount for Wet/Dry

117: Exciter - Mt.Delay (Exciter - Multitap Delay)

This effect combines a mono exciter and a multitap delay.

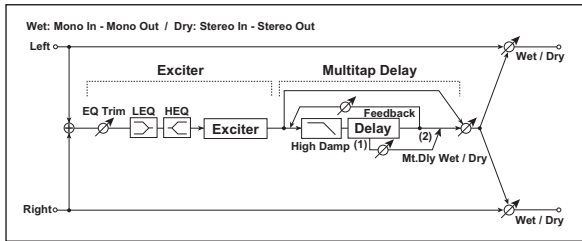

Paramter	Value	Explanation
Exciter		
X Blend	Blend	-100...+100
Frequency	Emphasis Frequency	0...70
X EQ Trim	Pre EQ Trim	0...100
X LEQ	Low EQ Gain [dB]	-15...+15
X HEQ	High EQ Gain [dB]	-15...+15
Multitap Delay		
DT1[ms]	Tap1 Time [ms]	0.0...1360.0
Tap1 Level	←	0...100
D T2 [ms]	Tap2 Time	0.0...1360.0
Fback(T2)	Feedback (Tap2)	-100...+100
HiDamp [%]	High Damp [%]	0...100
D W/D	[Dly]Wet/Dry	Dry, 1 : 99... 99 : 1, Wet
Src	[Dly]Source	Off...Tempo
Amt	[Dly]Amount	-100...+100
Wet/Dry	←	Dry, 1 : 99... 99 : 1, Wet
Src	Source	Off...Tempo
Amt	Amount	-100...+100

118: OD/HG - Mt.Delay (Overdrive/ Hi.Gain - Multitap Delay)

This effect combines a mono overdrive/high-gain distortion and a multitap delay.

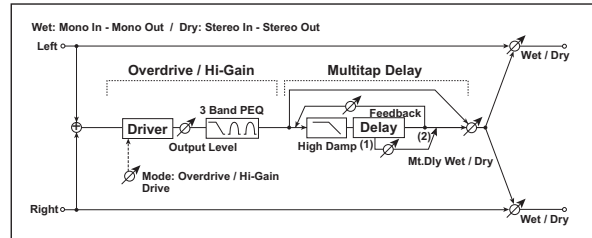

Paramter	Value	Explanation
Overdrive/Hi-Gain		
O Mode	Drive Mode	Overdrive, Hi-Gain
Drive	←	1...100
O Out Level	Level	0...50
Src	Source	Off...Tempo
Amt	Amount	-50...+50
O Low [Hz]	Low Cutoff [Hz]	20...1.00k
Gain	Low Gain [dB]	-18...+18
O Mid 1[Hz]	Mid1 Cutoff [Hz]	300...10.00k
Q	Mid1 Q	0.5...10.0
Gain	Mid Gain [dB]	-18...+18
O Mid22[Hz]	Mid2 Cutoff [Hz]	500...20.00k
Q	Mid2 Q	0.5...10.0
O Mid2 [dB]	Mid2 Gain [dB]	-18...+18
Multitap Delay		
DT1[ms]	Tap1 Time [ms]	0.0...549.0
DT1 Level	Tap1 Level	0...100
DT2 [ms]	Tap2 Time [ms]	0.0...549.0
D F.back	Feedback (Tap2)	-100...+100
HiDamp [%]	High Damp [%]	0...100
D W/D	[Dly]Wet/Dry	Dry, 1 : 99... 99 : 1, Wet
Src	[Dly]Source	Off...Tempo
Amt	[Dly]Amount	-100...+100
Wet/Dry	←	Dry, 1 : 99... 99 : 1, Wet
Src	Source	Off...Tempo
Amt	Amount	-100...+100

119: Cho/Flng - Mt.Dly (Chorus/Flanger - Multitap Delay)

This effect combines a mono chorus/flanger and a multitap delay.

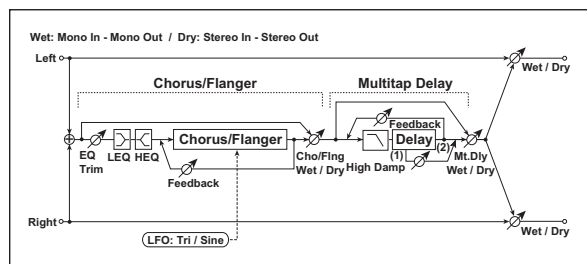

Parameter	Value	Explanation	
Chorus/Flanger			
F LFO[Hz]	LFO Freq [Hz]	0.02...20.00	Sets the speed of the LFO
LFO	LFO Waveform	Tri (Triangle), Sine	Selects the LFO Waveform
F Depth	Depth	0...100	Sets the depth of LFO modulation
Dly[ms]	Delay Time [ms]	0.0...50.0	Sets the delay time
F.back	Feedback	-100...+100	Sets the feedback amount p.246
F EQ Trim	Pre EQ Trim	0...100	Sets the EQ input level
F LEQ	[Low EQ Gain [dB]	-15...+15	Sets the gain of Low EQ
F HEQ	[High EQ Gain [dB]	-15...+15	Sets the gain of High EQ
F W/D	Wet/Dry	-Wet...-1 : 99, Dry, 1 : 99...Wet	Sets the effect balance of the chorus/flanger p.216, p.246
Multitap Delay			
D T1[ms]	Tap1 Time [ms]	0.0...489.0	Sets the Tap1 delay time
Tap1 Level	←	0...100	Sets the Tap1 output level p.257
D T2[ms]	Tap2 Time [ms]	0.0...489.0	Sets the Tap2 delay time
Fback(T2)	Feedback (Tap2)	-100...+100	Sets the Tap2 feedback amount
HiDamp [%]	High Damp [%]	0...100	Sets the damping amount in the high range p.256
D W/D	[Dly]Wet/Dry	Dry, 1 : 99... 99 : 1, Wet	Sets the multitap delay effect balance D^{mod}
Src	[Dly]Source	Off...Tempo	Selects the Wet/Dry modulation source for the multitap delay
Amt	[Dly]Amount	-100...+100	Sets the Wet/Dry modulation amount for the multitap delay
Wet/Dry	←	-Wet...-99 : 1, Dry, 99 : 1...Wet	Sets the balance between the effect and the dry input D^{mod}
Src	Source	Off...Tempo	Selects a modulation source for Wet/Dry
Amt	Amount	-100...+100	Sets the modulation amount for Wet/Dry

120: Reverb - Gate

This effect combines a mono reverb and a gate.

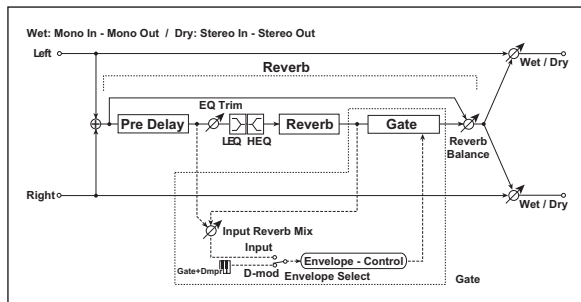

Parameter	Value	Explanation	
Reverb			
R Time[s]	Reverb Time [sec]	0.1...10.0	Sets the reverberation time
HiDmp[%]	High Damp [%]	0...100	Sets the damping amount in the high range
R Dly[ms]	Pre Delay [ms]	0...200	Sets the delay time of the reverb sound and gate control signal
Rev Bal	Reverb Balance	Dry, 1 : 99... 99 : 1, Wet	Sets the reverb effect balance
R EQ Trim	Pre EQ Trim	0...100	Sets the EQ input level
R LEQ Fc	Low EQ Frequency	Low, Mid-Low	Selects the cutoff frequency (low or mid-low) of the low-range equalizer
R HEQ Fc	High EQ Frequency	High, Mid-High	Selects the cutoff frequency (high or mid-high) of the high-range equalizer
R LEQ [dB]	Low EQ Gain [dB]	-15.0...+15.0	Sets the gain of Low EQ
R HEQ	High EQ Gain [dB]	-15.0...+15.0	Sets the gain of High EQ
Gate			
G Env Sel	Envelope Select	Dmod, Input	Switches between modulation source control and input signal control p.272
Src	Source	Off...Tempo	Selects the modulation source that controls the gate when Envelope Select is set to Dmod p.272 D^{mod}
G Thresh	Threshold	0...100	Sets the gate threshold level p.272
Polarity	←	+, -	Switches between non-invert and invert of the gate on/off state p.210
InMix	Input Reverb Mix	Dry, 1 : 99... 99 : 1, Wet	Sets the balance between the dry and reverb sounds of the gate control signal p.272
G Attack	←	1...100	Sets the attack time p.210
Release	←	1...100	Sets the release time p.210
Wet/Dry	←	Dry, 1 : 99... 99 : 1, Wet	Sets the balance between the effect and the dry input D^{mod}
Src	Source	Off...Tempo	Selects a modulation source for Wet/Dry
Amt	Amount	-100...+100	Sets the modulation amount for Wet/Dry

Envelope Select

Source

Input Reverb Mix

Threshold

The “Envelope Select” parameter enables you to select whether turning the gate on and off is triggered by the input signal level or controlled directly by the modulation source. You can select from Off to Gate2+Dmpr for the Source parameter to specify the modulation source.

When “Envelope Select” is set to Input, the gate is controlled by the level of signals that are the combination of the dry sound and the reverb sound. When the signal level exceeds the threshold, the gate opens and the reverb sound is output.

Normally, set “Input Reverb Mix” to Dry (the gate is controlled only by the dry sound). If you wish to extend the gate time, set the “Input Reverb Mix” value higher and adjust the “Threshold” value.

Double Size effects

D00: St.Multiband Limiter (Stereo Multiband Limiter)

This is a stereo multiband limiter.

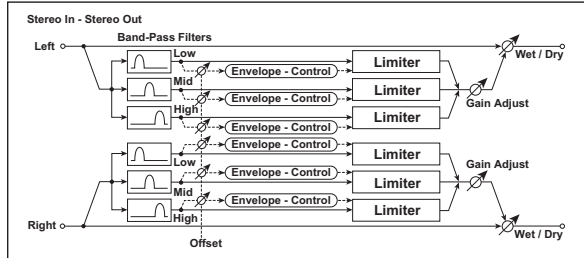

Paramter	Value	Explanation
Ratio	← 1.0 : 1... 50.0 : 1, Inf : 1	Sets the signal compression ratio p.208
Thrsh[dB]	Threshold [dB] -40...0	Sets the level above which the compressor is applied p.208
Attack	← 1...100	Sets the attack time
Release	← 1...100	Sets the release time
Lo Ofs[dB]	Low Offset [dB] -40...0	Sets the low range gain of trigger signal p.209
M. Ofs[dB]	Mid Offset [dB] -40...0	Sets the mid range gain of trigger signal p.209
Hi Ofs[dB]	High Offset [dB] -40...0	Sets the high range gain of trigger signal p.209
Gain [dB]	Gain Adjust [dB] -Inf, -38...+24	Sets the output gain p.208 D-mod
Src	Source Off...Tempo	Selects the modulation source for the output gain
Amt	Amount -63...+63	Sets the modulation amount of the output gain
Wet/Dry	← Dry, 1 : 99... 99 : 1, Wet	Sets the balance between the effect and the dry input D-mod
Src	Source Off...Tempo	Selects a modulation source for Wet/Dry
Amt	Amount -100...+100	Sets the modulation amount for Wet/Dry

D01: OD/HyperGain Wah (Overdrive/Hyper Gain Wah)

This distortion effect has two modes: overdrive and hyper-gain that produces a strong distortion. A higher high-gain setting is required for this effect relative to a normal-size effect.

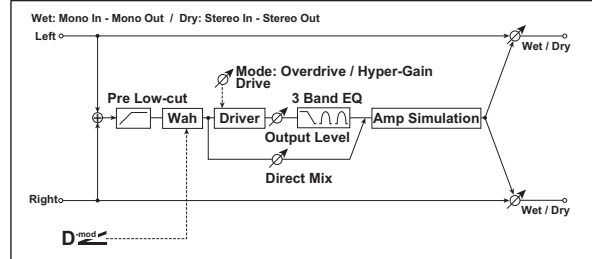

Paramter	Value	Explanation
← Wah	Off, On	Switches Wah on/off p.220 D-mod
Src	Source Off...Tempo	Selects the modulation source that switches the Wah on and off p.220
Sw	Switch Mode Toggle, Moment	Selects the switching mode for the modulation source that switches the Wah on and off p.220
Wah Range	← -10...+10	Sets the range of Wah p.220
Wah Sweep Src	Wah Sweep Source Off...Tempo	Selects the modulation source that controls the Wah p.220 D-mod
Mode	Drive Mode Overdrive, Hyper-Gain	Switches between overdrive and hi-gain distortion
Drive	← 1...120	Sets the degree of distortion p.220
Pre Low-cut	Pre Low Cut 0...10	Sets the low range cut amount of the distortion input p.220
Out Level	← 0...50	Sets the output level p.220 D-mod
Src	Source Off...Tempo	Selects the modulation source for the output level
Amt	Amount -50...+50	Sets the modulation amount of the output level
Low F[Hz]	Low Cutoff [Hz] 20...1.00k	Sets the center frequency for Low EQ (shelving type)
Gain[dB]	Gain [dB] -18...+18	Sets the gain of Low EQ
Mid1 F[Hz]	Mid1 Cutoff [Hz] 300...10.00k	Sets the center frequency for Mid/High EQ 1 (peaking type)
Q	Q 0.5...10.0	Sets the band width of Mid/High EQ 1 p.211
Gain[dB]	Gain [dB] -18...+18	Sets the gain of Mid/High EQ 1
Mid2 F[Hz]	Mid2 Cutoff [Hz] 500...20.00k	Sets the center frequency for Mid/High EQ 2 (peaking type)
Q	Q 0.5...10.0	Sets the band width of Mid/High EQ 2 p.211
Gain[dB]	Gain [dB] -18...+18	Sets the gain of Mid/High EQ 2
Direct Mix	← 0...50	Sets the amount of the dry sound mixed to the distortion

SpeakerSim	Speaker Simulation	Off, On	Switches the speaker simulation on/off	
Wet/Dry	←	Dry, 1 : 99... 99 : 1, Wet	Sets the balance between the effect and the dry input	
Src	Source	Off...Tempo	Selects a modulation source for Wet/Dry	
Amt	Amount	-100...+100	Sets the modulation amount for Wet/Dry	

D02: GuitarAmp + P4EQ (Guitar Amp Model + Parametric 4-Band EQ)

This combines a guitar amp simulation (which even faithfully replicates the distortion and tone control circuitry) with a four-band equalizer.

By using this in conjunction with “021: St. Guitar Cabinet (Stereo Guitar Cabinet)” p.221, you can obtain an even more realistic guitar sound that simulates a guitar amp + speaker cabinet.

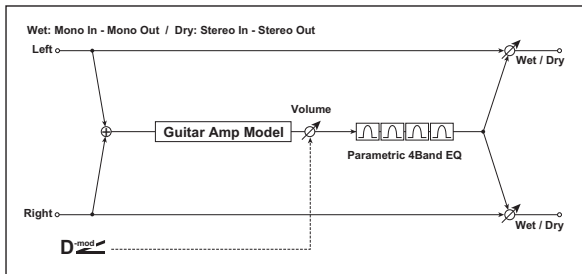

Paramter	Value	Explanation	
Amp Type	Guitar Amp Type VOX AC15, VOX AC15TB, VOX AC30, VOX AC30TB, UK BLUES, UK 70'S, UK 80'S, UK 90'S, UK MODERN, US MODERN, US HIGAIN, BOUTIQUE OD, BOUTIQUE CL, BLACK 2x12, TWEED - 1x12, TWEED - 4x10	Selects the type of the amplifier p.274	
Drive Gain	←	0...100	Sets the input gain
Volume	←	0...100	Sets the output level
Src	Source	Off...Tempo	Selects the modulation source for the output level
Amt	Amount	-100...+100	Sets the modulation amount of the output level
Bass	←	0...100	Sets the bass (low range) level
Middle	←	0...100	Sets the middle (mid range) level
Treble	←	0...100	Sets the treble (high range) level
Cut(VOX)/Presen	←	0...100	Sets the presence (high-frequency tone) p.274
Post P4EQ	P4EQ EQ Switch	Thru, On	Selects through or on for the equalizer p.274
B1 F [Hz]	Band1 Cutoff [Hz]	20...1.00k	Sets the center frequency of Band 1
Q	Q	0.5...10.0	Sets Band 1's bandwidth
Gain [dB]	Gain [dB]	-18...+18	Sets the gain of Band 1
B2 F [Hz]	Band2 Cutoff [Hz]	50...5.00k	Sets the center frequency of Band 2
Q	Q	0.5...10.0	Sets Band 2's bandwidth

Gain [dB]	Gain [dB]	-18...+18	Sets the gain of Band 2
B3 F [Hz]	Band3 Cutoff [Hz]	300...10.00k	Sets the center frequency of Band 3
Q	Q	0.5...10.0	Sets Band 3's bandwidth
Gain [dB]	Gain [dB]	-18...+18	Sets the gain of Band 3
B4 F [Hz]	Band4 Cutoff [Hz]	500...20.00k	Sets the center frequency of Band 4
Q	Q	0.5...10.0	Sets Band 4's bandwidth
Gain [dB]	Gain [dB]	-18...+18	Sets the gain of Band 4
Wet/Dry	←	Dry, 1 : 99... 99 : 1, Wet	Sets the balance between the effect and the dry input
Src	Source	Off...Tempo	Selects a modulation source for Wet/Dry
Amt	Amount	-100...+100	Sets the modulation amount for Wet/Dry

Guitar Amp Type

Cut (VOX)/Presence

If the Amp Type is VOX AC15...VOX AC30TB, this sets the attenuation of the high-frequency range. For other types, this sets the boost of the high-frequency range.

This corresponds to the Cut knob control of amps made by the VOX Corporation.

Post P4EQ

By chaining this with S021: St.Gt Cab you can simulate the combination of a guitar amp and speaker cabinet. In this case, we recommend that you set “Post P4EQ” to “Thru,” but if necessary you can turn it “On” and adjust the tone.

Recommended Combinations of Guitar Amp Models and Cabinet Simulators:

Amp Type	Cabinet Type
VOX AC15	VOX AC15 - 1x12
VOX AC15TB	VOX AC15 - 1x12
VOX AC30	VOX AC30 - 2x12
VOX AC30TB	VOX AC30 - 2x12
UK BLUES	UK H30 - 4x12
UK 70'S	UK H30 - 4x12
UK 80'S	UK T75 - 4x12
UK 90'S	UK T75 - 4x12
UK MODERN	UK T75 - 4x12, US V30 - 4x12
US MODERN	US V30 - 4x12
US HIGAIN	US V30 - 4x12, UK T75 - 4x12
BOUTIQUE OD	UK H30 - 4x12
BOUTIQUE CL	UK H30 - 4x12
BLACK 2x12	BLACK - 2x12
TWEED - 1x12	TWEED - 1x12
TWEED - 4x10	TWEED - 4x10

D03: G.Amp Clean Combo

This models the clean channel of a amp that went on sale in 1975 and contained two 12" speakers. As the name suggests, it produces a clean tone with a tight sounding character, and a deep and compact low-end.

D04: G.Amp California

This American combo amp with four 10" speakers was produced during the years 1963–1968, and was known for its big, clean sound and its warm and husky sound when driven heavily.

D05: G.AmpTweed

This American-made tweed-covered 1957 model combo amp with two 12" speakers is known for its rich, clean tone that is ideal for classic rock, blues, and country. By raising the volume you can also produce a powerful and punchy overdrive sound.

D06: G.Amp Modded OD

This models a 100W boutique amp head produced in North Hollywood. An overdrive tone with a rich harmonic structure is combined with a relaxed sustain, making for an enjoyable playing experience.

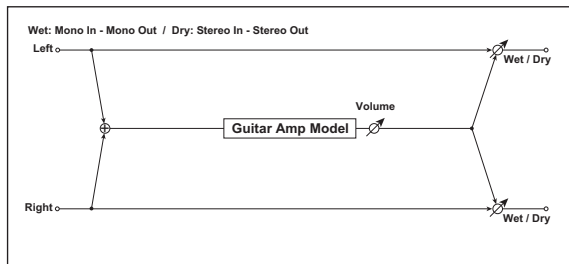

Paramter	Value	Explanation	
Drive	←	0...100	Sets the input gain
Volume	←	0...100	Sets the output level
Bass	←	0...100	Sets the bass (low range) level
Middle	←	0...100	Sets the middle (mid range) level
Treble	←	0...100	Sets the treble (high range) level
Presence	←	0...100	Sets the presence (high-frequency tone)
Wet/Dry	←	Dry, 1 : 99...99 : 1, Wet	Sets the balance between the effect and the dry input
Src	Source	Off...Tempo	Selects a modulation source for Wet/Dry
Amt	Amount	-100...+100	Sets the modulation amount for Wet/Dry

Examples of amp and cabinet combinations

We recommend that you use these amp model effects in a chain with the cabinet model effect (S21: St.Gt Cab). You are free to use any combination to create a variety of sounds, so try out various combinations and listen to the result. Here are some typical combinations.

D03: G.Amp Clean Combo	1x12 TWEED
	2x10 BLACK
	2x12 BLACK
	4x12 UK H30

D04: G.Amp California	1x12 TWEED
	4x10 TWEED
	2x12 BLACK
	4x12 UK H30
D05: G.Amp Tweed	1x12 TWEED
	2x10 BLACK
	2x12 BLACK
D06: G.Amp Modded OD	4x12 UK T75
	4x12 US V30

D07: Bass.TubeAmp + Cab (Bass Tube Amp Model + Cabinet)

This simulates a bass amp (with gain and drive) and speaker cabinet.

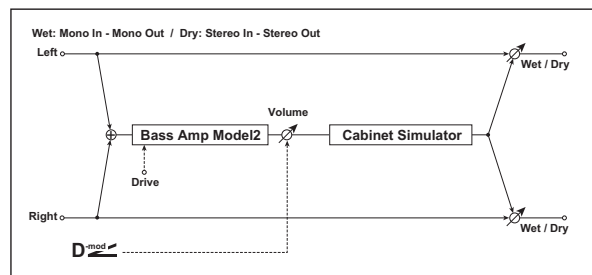

Paramter	Value	Explanation	
Amp Type	Bass Amp Amp Type	STUDIO COMBO VOX AC100 UK MAJOR	Selects the type of the amplifier p.274 A tube combo ideal for the Motown sound A 100W tube amp AC100 made by Vox A 200W tube amp made in the UK
Drive Gain	Drive Gain	0...100	Sets the input gain
Volume	Volume	0...100	Sets the output level
Src	Source	Off...Tempo	Selects the modulation source for the output level
Amt	Amount	-100...+100	Sets the modulation amount of the output level
Bass	←	0...100	Sets the bass (low range) level
Middle	←	0...100	Sets the middle (mid range) level
Treble	←	0...100	Sets the treble (high range) level
Presence	←	0...100	Sets the presence (high-frequency tone)
Cabnet Sim	Cabinet Simulator	Off, On	Switches the cabinet simulator on/off
Type	Cabinet Type	LA - 4x10, MODERN - 4x10, METAL - 4x10, CLASSIC - 8x10, UK - 4x12, STUDIO - 1x15, JAZZ - 1x15, VOX AC100 - 2x15, US - 2x15, UK - 4x15, LA - 1x18, COMBI - 1x12 & 1x18	Selects the cabinet type p.223, p.276
Wet/Dry	←	Dry, 1 : 99...99 : 1, Wet	Sets the balance between the effect and the dry input
Src	Source	Off...Tempo	Selects a modulation source for Wet/Dry
Amt	Amount	-100...+100	Sets the modulation amount for Wet/Dry

**Amp Type
Cabinet Type**

Recommended Combinations of Bass Amp Models and Cabinets:

Amp Type	Cabinet Type
STUDIO COMBO	STUDIO - 1x15
VOX AC100	VOX AC100 - 2x15
UK MAJOR	UK - 4x15, UK - 4x12

D08: St. Mic + PreAmp (Stereo Mic Modeling + PreAmp)

This is a stereo mic and preamp simulator (See “028: Mic Model+PreAmp (Mic Modeling + PreAmp)” on page 224.). For example you might use this to simulate micing of a stereo source such as a rotary speaker.

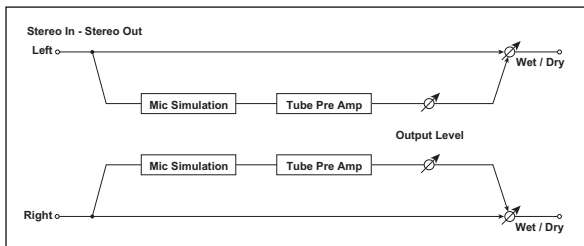

D09: Vocoder

This effect modifies the input signal (carrier) by giving it the tonal character of a different signal (the modulation). The most popular way to use this is to input a vocal signal from a connected mic as the modulator, creating the impression that the musical instrument is speaking. You can also obtain distinctive effects by using rhythm or sound effects. The most appropriate choice of carrier is a sound that contains numerous overtones, such as strings or distorted guitar.

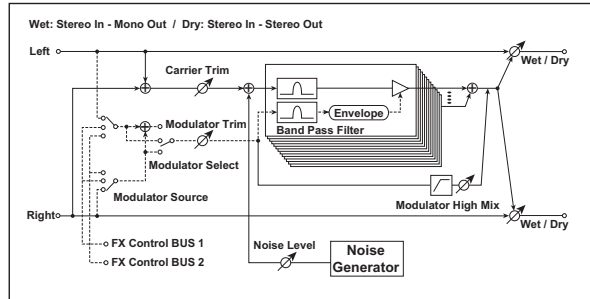

Parameter	Value	Explanation
Carrier Trim	← 0...100	Sets the Carrier input level
Modulator Trim	← 0...100	Sets the Modulator input level
Mod Src	Mod Source	Input, FX Control 1, FX Control 2
Mod. Select	← L/R Mix, L Only, R Only	Selects whether to use the left/right mix, only left, or only right of the modulator input
FormntSft	Formant Shift -2...+2	Sets the height of the frequency for the vocoder effect p.276
Response	← 0...100	Sets the speed of the response to the modulator input
CarrierNoise	Carrier Noise Level 0...100	Sets the noise mix level to the Carrier p.276
Src	Source Off...Tempo	Selects the modulation source for the noise mix level
Amt	Amount -100...+100	Sets the modulation amount for the noise mix level
Mod. Hi Mix	Mod. High Mix 0...100	Sets the high-range output level of the modulator p.276
LowGain[dB]	Low Gain [dB] -12...+12	Sets the low-range output level of the vocoder
HiGain[dB]	High Gain [dB] -12...+12	Sets the high-range output level of the vocoder
Wet/Dry	← Dry, 1 : 99... 99 : 1, Wet	Sets the balance between the effect and the dry input
Src	Source Off...Tempo	Selects a modulation source for Wet/Dry
Amt	Amount -100...+100	Sets the modulation amount for Wet/Dry

Formant Shift

By offsetting the Carrier filter, you can adjust the height of the frequency range where the vocoder effect is applied. The tonal quality will change significantly.

CarrierNoise Level

This parameter enables you to mix white noise with the Carrier.

Mod. High Mix

This parameter sets the high-range output level of the modulator sound. If the modulator is a human voice, it will make the words more clear.

D10: Rotary SpeakerOD (Rotary Speaker Overdrive)

This is a stereo rotary speaker effect. It has an internal speaker simulator that simulates overdrive (recreating the amp distortion) and characteristics of the rotary speaker, producing a very realistic rotary speaker sound.

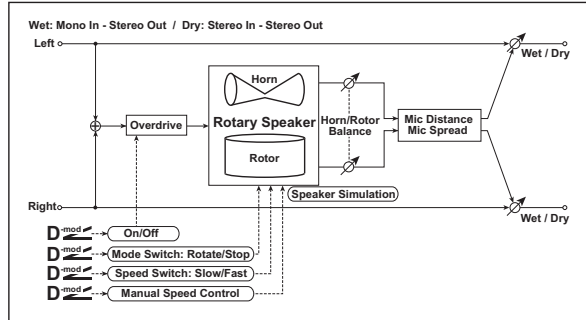

Paramter	Value	Explanation	
Overdrive	Off, On	Switches overdrive on/off	
Src	Source	Off...Tempo	Selects a modulation source to switch overdrive on/off
Sw	Switch Mode	Toggle, Moment	Sets the switch mode for overdrive on/off modulation p.277
OD Gain	←	0...100	Determines the degree of distortion
OD Level	←	0...100	Sets the overdrive output level
OD Tone	←	0...15	Sets the tonal quality of the overdrive
SpeakerSim	Speaker Simulator	Off, On	Switches the speaker simulation on/off
Mode Sw	Mode Switch	Rotate, Stop	Switches between speaker rotation and stop D-mod
Src	Source	Off...Tempo	Selects a modulation source for Rotate/Stop
Speed Sw	Switch Mode	Toggle, Moment	Sets the switch mode for Rotate/Stop modulation p.242
Speed SW	Speed Switch	Slow, Fast	Switches the speaker rotation speed between slow and fast D-mod
Src	Source	Off...Tempo	Selects a modulation source for Slow/Fast
Sw	Switch Mode	Toggle, Moment	Sets the switch mode for Slow/Fast modulation p.242
H/R Bal.	H/R. Balance	Rotor, 1...99, Horn	Sets the volume balance between the high-range horn and low-range rotor
Manu Spd Ctl	Manual Speed Control	Off...Tempo	Sets a modulation source for direct control of rotation speed p.242 D-mod
Horn Accel	Horn Acceleration	0...100	Sets how quickly the horn rotation speed changes p.242
Horn Ratio	Ratio	Stop, 0.50...2.00	Adjusts the (high-frequency) horn rotation speed. Standard value is 1.00. "Stop" stops the rotation
Rotor	Rotor Acceleration	0...100	Sets how quickly the rotor speed changes p.242
Rotor Ratio	←	Stop, 0.50...2.00	Adjusts the (low-frequency) rotor rotation speed. Standard value is 1.0. "Stop" stops the rotation

Mic Distnce	Mic Distance	0...100	Distance between the microphone and rotary speaker p.242	
Mic Spread	←	0...100	Angle of left and right microphones p.242	
Wet/Dry	←	Dry, 1 : 99... 99 : 1, Wet	Sets the balance between the effect and the dry input D-mod	
Src	Source	Off...Tempo	Selects a modulation source for Wet/Dry	
Amt	Amount	-100...+100	Sets the modulation amount for Wet/Dry	

Switch Mode

This parameter determines how to switch on/off the overdrive via a modulation source.

When "Switch Mode" = Toggle, overdrive is turned on/off each time the pedal or modulation wheel is used.

MIDI Overdrive will be switched on/off each time the value of the modulation source exceeds 64.

When "Switch Mode" = Moment, overdrive is applied only when you press the pedal or use the modulation wheel.

MIDI Only when the value for the modulation source is 64 or higher, the overdrive effect is applied.

D11: Multitap Cho/Delay (Multitap Chorus/Delay)

This effect has six chorus blocks with different LFO phases. You can produce a complex stereo image by setting a different delay time and depth for each block. You can control the delay output level via a modulation source.

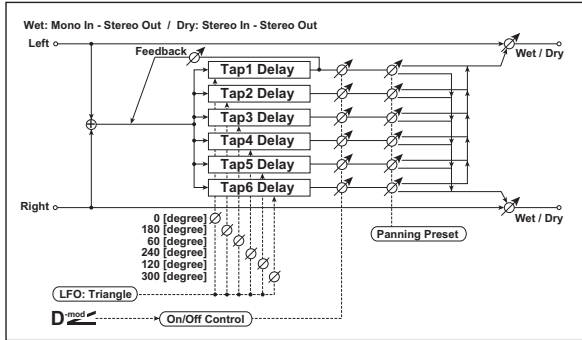

Parameter	Value	Explanation
Tap1 [ms]	Tap1 Delay (000) [ms] 0...650	Sets the Tap1 (LFO phase=0 degrees) delay time
Dep	Tap1 Depth 0...30	Sets the Tap1 chorus depth
Status	Tap1 Status Always On, Always Off, On→Off, Off→On	Selects on, off, or modulation source for the control of Tap1 output p.278
Tap2 [ms]	Tap2 Delay (180) [ms] 0...650	Sets the Tap2 (LFO phase=180 degrees) delay time
Dep	Tap2 Depth 0...30	Sets the Tap2 chorus depth
Status	Tap2 Status Always On, Always Off, On→Off (Dm), Off→On (Dm)	Selects on, off, or modulation source for the control of Tap2 output p.278
Tap3 [ms]	Tap3 Delay (060) [ms] 0...2000	Sets the Tap3 (LFO phase=60 degrees) delay time
Dep	Tap3 Depth 0...30	Sets the Tap3 chorus depth
Status	Tap3 Status Always On, Always Off, On→Off (Dm), Off→On (Dm)	Selects on, off, or modulation source for the control of Tap3 output p.278
Tap4 [ms]	Tap4 Delay (240) [ms] 0...2000	Sets the Tap4 (LFO phase=240 degrees) delay time
Dep	Tap4 Depth 0...30	Sets the Tap4 chorus depth
Status	Tap4 Status Always On, Always Off, On→Off (Dm), Off→On (Dm)	Selects on, off, or modulation source for the control of Tap4 output p.278
Tap5 [ms]	Tap5 Delay (120) [ms] 0...2000	Sets the Tap5 (LFO phase=120 degrees) delay time
Dep	Tap5 Depth 0...30	Sets the Tap5 chorus depth
Status	Tap5 Status Always On, Always Off, On→Off (Dm), Off→On (Dm)	Selects on, off, or modulation source for the control of Tap5 output p.278
Tap6 [ms]	Tap6 Delay (300) [ms] 0...2000	Sets the Tap6 (LFO phase=300 degrees) delay time
Dep	Tap6 Depth 0...30	Sets the Tap6 chorus depth

Status	Tap6 Status	Always On, Always Off, On→Off (Dm), Off→On (Dm)	Selects on, off, or modulation source for the control of Tap6 output p.278
LFO [Hz]	LFO Freq [Hz]	0.02...13.00	Sets the speed of the LFO
Pan Preset	Panning Preset	1:L 123456R 2:L 135 246R 3:L 135246R 4:L 145632R	Selects the stereo panning pattern for each tap p.278
Feedback	Tap1 Feedback	-100...+100	Sets the Tap1 feedback amount D mod
Src	Source	Off...Tempo	Selects the modulation source for the Tap output level, feedback amount, and effect balance
Amt	Amount	-100...+100	Sets the modulation amount of Tap1 feedback amount
Wet/Dry	←	Dry, 1 : 99... 99 : 1, Wet	Sets the balance between the effect and the dry input D mod
Src	Source	Off...Tempo	Selects a modulation source for Wet/Dry
Amt	Amount	-100...+100	Sets the modulation amount for Wet/Dry

Status

These parameters set the output status of each Tap.

Always On: Output is always on. (No modulation)

Always Off: Output is always off. (No modulation)

On→Off (dm): Output level is switched from on to off depending on the modulation source.

Off→On (dm): Output level is switched from off to on depending on the modulation source.

Combining these parameters, you can change from 4-phase chorus to two-tap delay by crossfading them gradually via the modulation source during a performance.

Panning Preset

This parameter selects combinations of stereo images of the tap outputs.

D12: St. Pitch Shifter (Stereo Pitch Shifter)

This is a stereo pitch shifter. The pitch shift amount for the left and right channels can be reversed from each other.

You can choose from three types: a type with rapid response, a type with minimal tonal change and a type between these two.

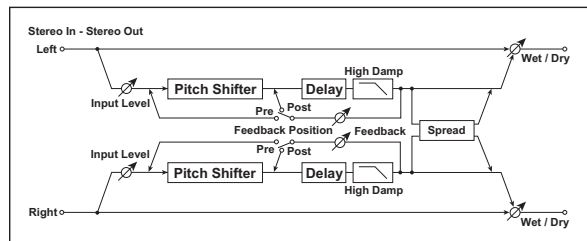

Parameter	Value	Explanation	
Mode	←	Slow, Med., Fast	Switches Pitch Shifter mode p.242
L/R Pitch	←	Normal, Up/Down	Determines whether or not the L/R pitch shift amount is inverted p.279
Pitch Shift	Shift [1/2tone]	-24...+24	Sets the pitch shift amount in steps of a semitone p.251
Src	Source	Off...Tempo	Selects the modulation source of pitch shift amount p.251
Amt	Amount	-24...+24	Sets the modulation amount of pitch shift amount p.251
Fine [c]	Fine [cents]	-100...+100	Sets the pitch shift amount in steps of one cent p.251
Amt	Amount	-100...+100	Sets the modulation amount of pitch shift amount p.251
L Dly[ms]	L Delay Time [ms]	0...160	Sets the delay time for the left channel
R Dly[ms]	R Delay Time [ms]	0...160	Sets the delay time for the right channel
FB Posit	Feedback Position	Pre, Post	Switches the feedback connection p.251
InLvl Dmod	Input Level Dmod [%]	-100...+100	Sets the modulation amount of the input level p.250
Src	Source	Off...Tempo	Selects the modulation source for the input level p.250
Feedback	←	-100...+100	Sets the feedback amount p.251
HiDamp [%]	High Damp [%]	0...100	Sets the damping amount in the high range
Spread	←	-100...+100	Sets the width of the stereo image of the effect sound p.256
Wet/Dry	←	Dry, 1 : 99... 99 : 1, Wet	Sets the balance between the effect and the dry input
Src	Source	Off...Tempo	Selects a modulation source for Wet/Dry
Amt	Amount	-100...+100	Sets the modulation amount for Wet/Dry

L/R Pitch

When you select Up/Down for this parameter, the pitch shift amount for the right channel will be reversed. If the pitch shift amount is positive, the pitch of the left channel is raised, and the pitch of the right channel is lowered.

Mode

Switches the operating mode of the pitch shifter. Slow minimizes the tonal change, and Fast provides fast response. Med. is between these two choices. Choose the Fast mode if you need only a small amount of pitch shift, and choose Slow if you need a large amount of pitch shift.

D13: Early Reflections

This early reflection effect has more precise early reflections with twice the maximum length of a normal-size effect (See “113: Early Reflections” on page 268.). You can create a very smooth and dense sound.

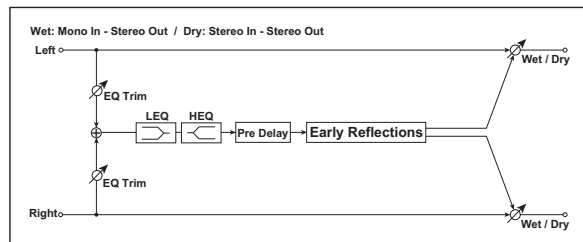

Parameter	Value	Explanation	
Type	←	Sharp, Loose, Modulated, Reverse	Selects the decay curve for the early reflection p.268
Time [ms]	ER Time [ms]	10...540	Sets the time length of early reflection
PreDl[ms]	Pre Delay [ms]	0...200	Sets the time taken from the original sound to the first early reflection
PreEQ Trim	Pre EQ Trim	0...100	Sets the input level of EQ applied to the effect sound
Pre LEQ Fc	Low EQ Frequency	Low, Mid-Low	Selects the cutoff frequency (low or mid-low) of the low-range equalizer
Pre HEQ Fc	High EQ Frequency	High, Mid-High	Selects the cutoff frequency (high or mid-high) of the high-range equalizer
LEQ [dB]	Low EQ Gain [dB]	-15.0...+15.0	Sets the gain of Low EQ
HEQ [dB]	High EQ Gain [dB]	-15.0...+15.0	Sets the gain of High EQ
Wet/Dry	←	Dry, 1 : 99... 99 : 1, Wet	Sets the balance between the effect and the dry input
Src	Source	Off...Tempo	Selects a modulation source for Wet/Dry
Amt	Amount	-100...+100	Sets the modulation amount for Wet/Dry

Appendices

Alternate Modulation Sources (AMS)

Alternate Modulation Overview

Alternate Modulation lets you use controllers, envelopes, LFOs, etc. to modulate Program parameters. You can use one controller to modulate multiple parameters simultaneously. You can also create complex modulation setups where (for example) an envelope modulates the frequency of an LFO, and that LFO is then used to modulate a filter.

Programs provide 46 types (84 destinations) for alternate modulation.

Alternate Modulation Sources

You can use the sources listed on the following page to control Alternate Modulation. If you select two or more Alternate Modulation destinations for control by the same AMS, a single source will apply modulation to each of the specified destinations.

Frequently used assignments such as using pitch bend wheel to control pitch are provided as special parameters, so it is not necessary to use Alternate Modulation to accomplish this.

AMS Mixers

The AMS Mixers combine two AMS sources into one, or process an AMS source to make it into something new.

For instance, they can add two AMS sources together, or use one AMS source to scale the amount of another. You can also use them to change the shapes of LFOs and EGs in various ways, modify the response of realtime controllers, and more.

The AMS Mixer outputs appear in the list of AMS sources, just like the LFOs and EGs.

The original, unmodified inputs to the AMS Mixers are still available as well. For instance, if you use LFO 1 as an input to a AMS Mixer, you can use the processed version of the LFO to control one AMS destination, and the original version to control another.

Finally, you can cascade two AMS Mixers together, by using one as the input of another.

For more information, please see “12-1: 1 (AMS Mixer1)” on page 45.

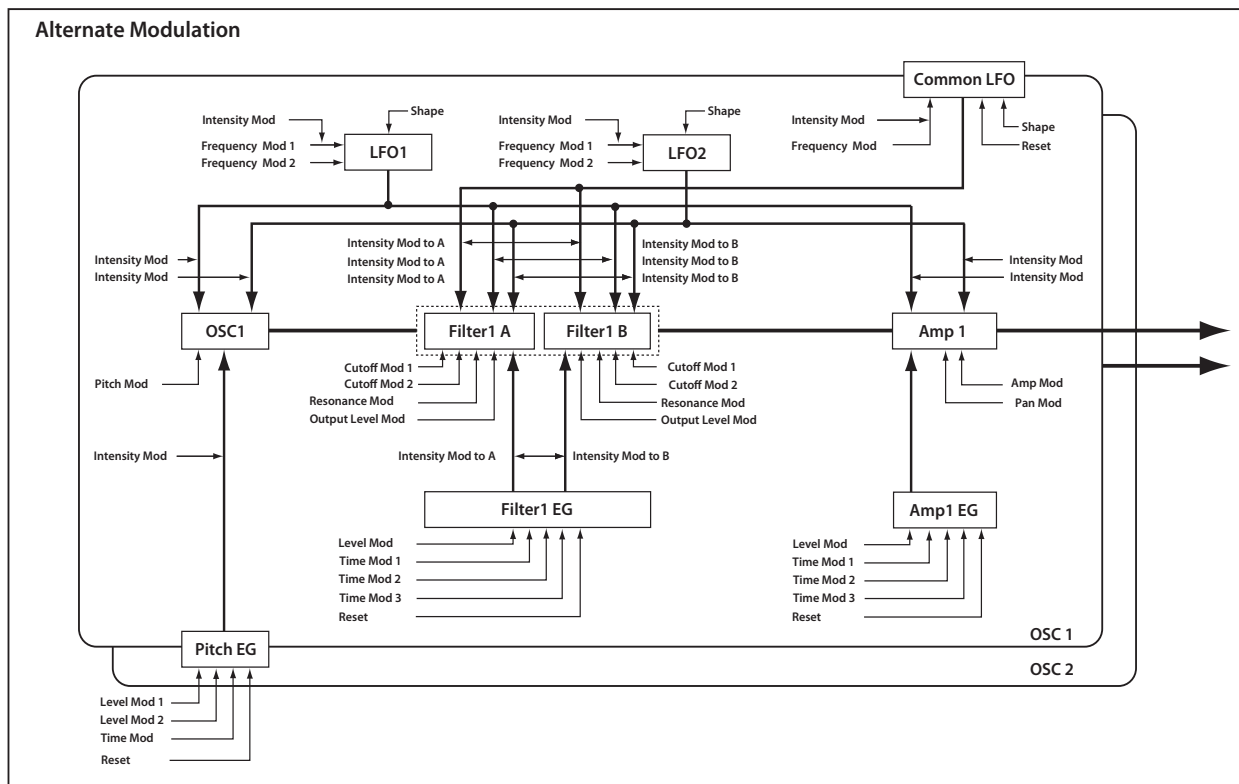

AMS (Alternate Modulation Source) List

Physical and MIDI controllers

Off

This means that no modulation source is selected.

Note Number

This is the note's MIDI note number, from 0 (C-2) to 127 (G9).

Velocity

This is the note's MIDI note-on velocity.

Exp. Velocity (Exponential Velocity)

This is MIDI note-on velocity through an exponential curve. The curve means that low velocities won't have very much effect, and the difference between two lower velocity values won't be very noticeable.

On the other hand, high velocities produce increasingly greater effects, and the difference between any two higher velocity values will be more pronounced.

Poly After

Polyphonic aftertouch allows a different aftertouch value for each note. This can be received from external MIDI devices or generated by the internal sequencer. The KROSS keyboard itself does not generate poly aftertouch, however.

After Touch

The effect will be applied by channel aftertouch messages from the KROSS's sequence data or received from MIDI IN.

Pitch Bend

This is the movement of the pitch bend wheel. It also receives MIDI Pitchbend.

M.Wheel:#01

This is the movement of the modulation wheel. It also receives MIDI CC#01 (mod wheel).

JS-Y: #02

It receives MIDI CC#02 (breath controller).

M.Whl& AT/2 (Modulation Wheel & After Touch/2)

The effect will be controlled by the modulation wheel (away from yourself) and by aftertouch. In this case, the effect of aftertouch will be only half of the specified intensity.

JS -Y & AT/2 (Joy Stick -Y & After Touch/2)

This AMS source receives MIDI CC#02 and aftertouch. In this case, the effect of aftertouch will be only half of the specified intensity.

Pedal: #04 (Foot Pedal: CC#04)

This AMS source receives MIDI CC#04. It can also be generated by a foot pedal connected to the rear-panel ASSIGNABLE PEDAL input, if the Global **Foot Pedal Assign** parameter is set to Foot Pedal (CC#04). For more information, please see the "Foot Pedal Assign" section on page 292.

KnobMod1: #17 (CC#17)

KnobMod2: #19 (CC#19)

KnobMod3: #20 (CC#20)

KnobMod4: #21 (C#21)

The effect will be applied by the sequence data of the KROSS or by control change data received via MIDI IN.

If AMS intensity is set to a positive (+) value, 64 (center) means no modulation; and 127 causes the maximum positive modulation.

KnobMod1[+]

KnobMod2[+]

KnobMod3[+]

KnobMod4[+]

The effect will be applied by the sequence data of the KROSS or by control change data received via MIDI IN.

With these AMS sources, the value and the direction of the resulting change are different than KnobMod1: #17–KnobMod4: #21. If AMS intensity is set to a positive (+) value, set to 0 produce an AMS effect of 0. Increasing the value will apply change only in the positive direction. (If the intensity is set to a negative value, the result will be the opposite.)

Damper: #64

This is the Damper pedal, also sometimes called the sustain pedal. It corresponds to MIDI CC#64.

When using Korg's optional half-damper pedal, the DS-1H, this AMS source is continuous—not just on/off.

Porta.SW: #65

This is the MIDI portamento switch (CC#65), which also enables and disables portamento.

Sostenuto: #66

This is the MIDI sostenuto pedal (CC#66).

Soft: #67

This is the MIDI oft pedal (CC#67).

SW 1: #80 (SW 1 Modulation: CC#80)

This is CC#80, which is the default for assignable front-panel switch 1 (SW1). To use SW1 and SW2 as AMS sources:

1. Go to the **INPUT/CTRL> CONTROLLERS** page.
2. Under **Panel Switch Assign**, assign **SW1 to SW1 Mod: #80 and SW2 to SW2 Mod: #81**.

These assignments are stored separately for each Program, Combination, and Song.

For more information, please see the "SW1/2 Assign" section on page 290.

SW 2: #81 (SW 2 Modulation: CC#81)

This is CC#81, which is the default for assignable front-panel switch 2 (SW2). For more information, please see "SW 1: #80 (SW 1 Modulation: CC#80)" above.

Foot SW: #82 (Foot SW: CC#82)

This AMS source receives MIDI CC#82. It can also be generated by a foot switch connected to the rear-panel ASSIGNABLE SWITCH input, if the Global **Foot Pedal Assign** parameter is set to Foot SW (CC#82). For more information, please see the "MIDI transmission when the KROSS's controllers are used" section on page 293.

MIDI: CC#83

MIDI control change (CC#83)

Tempo

This lets you use the system tempo as a modulation source. 120 is the center, for a value of 0; 60BPM is -99, and 240 BPM is +99.

Note that this is different from actually syncing to tempo; for that purpose, use the dedicated synchronization functions for the LFOs, effects, etc.

Gate1

Gate1+Damper

Gate 1 is triggered by a new note after all notes have been released, such as at the beginning of a phrase. Gate 1+Damper is similar, except that it is triggered by a new note-on after all notes and the damper are released.

You can use this to reset the Common LFO. For instance, to create an effect similar to the per-voice LFO and Step Sequencer's **Key Sync Off** setting, use **Gate 1 + Damper** as the reset source.

Gate2

Gate2+Damper

Gate 2 is similar to Gate 1, but it triggers with every new note-on, even in the middle of a legato phrase. Gate2+Damper includes the damper pedal in the equation, as shown in the diagram below.

Note: When used as a reset controller for Common LFO, Gate2 and Gate2+Damper will have the same effect.

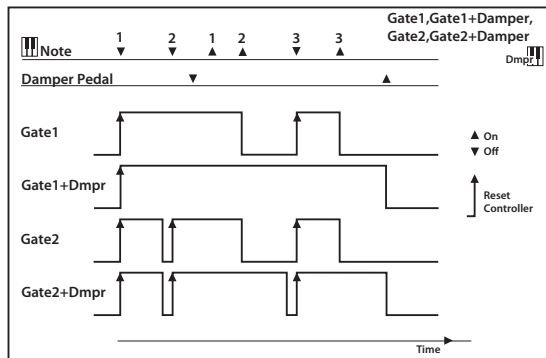

Alternate Modulation settings

When you use an AMS (Alternate Modulation Source), the modulation destination will be affected as shown in the table below.

By using alternate modulation, you can create complex systems of modulation where EG, LFO, keyboard tracks, and controllers work together.

- You can apply complex change to an LFO or EG, for example by using the pitch/filter/amp EG to control the frequency or intensity of an LFO that modulates the pitch/filter/amp, or by using LFO2 to control the frequency of LFO1.

- The tone, EG, and LFO etc. can be controlled by key velocity or the modulation wheel, and also from a button, or pedal etc.
- Panning can be controlled in realtime from a controller, EG, or LFO etc.
- You can use the filter EG to control pitch or volume at the same time that it controls the filter.
- Controllers etc. can be used to control EG levels or times. This lets you shape the EG in realtime.
- Filter/amp keyboard tracking or note number can be used to control the EG or LFO according to the keyboard pitch that is played.
- Pitch, tone, EG or LFO can be controlled by the tempo of the arpeggiator and/or sequencer.

AMS operations and their result

AMS source & value range	Amp EG 0...+99	Pitch & Filter EGs -99...0...+99	LFO1 & 2 -99...0...+99	Common LFO -99...0...+99	Filter & Amp Key Track -99...0...+99	Common Key Track 1 & 2 -99...0...+99	Note Number C-1...C4...C9	EXT(+/-)*1 -Max...0...+Max EXT (Tempo)*2 ↓=-.60.00...120.00...240.00...	EXT(+)*3 0...127
Parameter	AMS Intensity								
Pitch *4	(+12.00)	0...+1 Octave	-1...0...+1 Octaves (Filter EG as AMS; dedicated parameter for Pitch EG)	Dedicated parameter	-1...0...+1 Octaves	-	Dedicated parameter	-1...0...+1 Octaves	0...+1 Octave
Pitch EG Int.	(+12.00)	-	Dedicated parameter for Pitch EG	-	-1...0...+1 Octaves	-	-1...0...+1 Octaves	-	0...+1 Octave
Pitch LFO1/ 2 Int.	(+12.00)	0...+1 Octave	-1...0...+1 Octaves	-	-1...0...+1 Octaves	-	-	-	0...+1 Octave
Filter Frequency	(+99)	0...+10 Octaves	-10...0...+10 Octaves (Pitch EG as AMS; dedicated parameter for Filter EG)	Dedicated parameter	Dedicated parameter for Filter KTrk	-10...0...+10 Octaves	-	-10...0...+10 Octaves	0...+10 Octaves
Filter Resonance	(+99)	0...+99	-99...0...+99	-	-	-	-	-	0...+99
Filter EG Int.	(+99)	-	Dedicated parameter for Filter EG	-	-99...0...+99	-	-99...0...+99	-	0...+99
Filter LFO1/ 2 Int.	(+99)	0...+99	-99...0...+99	-	-99...0...+99	-	-	-	0...+99
Filter Output Level A/B	(+99)	0...+99	-99...0...+99	-	-	-	-	-	0...+99
Drive	(+99)	0...+99	-99...0...+99	-	-	-	-	-	0...+99
Low Boost	(+99)	0...+99	-99...0...+99	-	-	-	-	-	0...+99
Amp	(+99)	Dedicated parameter	0...1x...8x	Dedicated parameter	0...1x...8x	Dedicated parameter for Amp KTrk	-	-	0...1x...8x
Amp LFO1/ 2 Int.	(+99)	0...+99	-99...0...+99	-	-99...0...+99	-	-	-	0...+99
Pan	(+50)	0...+63	-63...0...+63	-	-	-	-	-	0...+63
EG Level	(+66)	-	-	-	-99...0...+99	-	-	-	0...+99
EG Time	(+49)	-	-	-	1/64x...1x...64x	-	-	-	1x...64x
LFO 1 Frequency *4	(+99)	1x...64x	1/64x...1x...64x (LFO2 only)	-	1/64x...1x...64x	-	-	-	1x...64x
LFO 2 Frequency *4	(+99)	1x...64x	-	-	1/64x...1x...64x	-	-	-	1x...64x
Common LFO Frequency *4	(+99)	-	-	-	-	-	1/64x...1x...64x	-	1x...64x
LFO 1 Shape	(+99)	0...+99	-99...0...+99 (LFO2 only)	-	-99...0...+99	-	-	-	0...+99
LFO 2 Shape	(+99)	0...+99	-	-	-99...0...+99	-	-	-	0...+99
Common LFO Shape	(+99)	-	-	-	-	-	-99...0...+99	-	0...+99

Notes for the table

- *1 EXT(+/-): Pitch Bend, Knob Mod1: CC#17, Knob Mod2: CC#19, Knob Mod3: CC#20, Knob Mod4: CC#21
- *2 When Tempo is selected as an AMS source, the base value is \downarrow =120.00.
For example if the Pitch AMS is set to Tempo, and Intensity is set to 12.00, doubling the tempo value (\downarrow =120.00 → 240.00) will raise the pitch one octave, and halving the tempo (\downarrow =120.00 → 60.00) will lower the pitch one octave. The stated modulation results are for tempo values between 60bpm and 240bpm. As the tempo decreases from 60 to 0bpm, AMS modulation will have increasingly negative effects; as it increases from 240 to 250bpm, modulation will have increasingly positive effects.
- *3 EXT(+): Velocity, Exp. Velocity, Poly After, After Touch, M.Wheel:#01, JS-Y:#02, M.Whl & AT/2, JS-Y & AT/2, Pedal:CC#04, ValueSldr:#18, Knob Mod1[+], Knob Mod2 [+], Knob Mod3[+], Knob Mod4[+], Damper:CC#64, Porta.SW:CC#65, Sostenuuto:CC#66, Soft:CC#67, SW1:CC#80, SW2:CC#81, MIDI:CC#83, MIDI:CC#85, MIDI:CC#86, MIDI:CC#87, MIDI:CC#88.
- *4 It is possible to control LFO Frequency by using Tempo AMS and Intensity. However if you use the Frequency MIDI/Tempo Sync function (see page 41), the LFO frequency can be synchronized to the tempo and note value.

The effects of AMS on various parameters, and example applications

We'll describe some examples of using alternate modulation.

Pitch (see page 15)

Pitch can be controlled by the Common LFO, filter/amp EG, controllers, or tempo etc.

- If you select Filter EG or Amp EG as the AMS and set Intensity to +12.00, the pitch will change up to ±1 octave in synchronization with the EG.
- If you select Tempo as the AMS and set Intensity to +12.00, doubling the tempo (based on \downarrow =120.00) will raise the pitch one octave, and halving the tempo will lower the pitch one octave.

Pitch EG (see page 15)

Pitch EG intensity can be controlled by the Common LFO, keyboard tracking, controllers, or tempo.

- If you select M.Wheel:#01 as the AMS and set Intensity to +12.00, moving the modulation wheel away from yourself will gradually increase the effect of the Pitch EG to a maximum of ±1 octave. If Intensity has a negative value, the effect of the Pitch EG will be inverted.

LFO 1/2 (see page 16)

Pitch modulation intensity of the LFO1/2 can be controlled by the Common LFO, an EG, keyboard tracking, controllers, or tempo etc.

- If you select EG as the AMS, the pitch change width of LFO modulation etc. can be controlled in synchronization with the level changes of the EG. With positive (+) settings of Intensity, the vibrato effect will gradually deepen as the EG level rises, or gradually lessen as the EG level decreases. With negative (-) settings of Intensity, the LFO phase will be inverted.
- If you select a controller such as SW1 or 2 as the AMS, you can press the SW1 or SW2 switch when desired to turn on the vibrato effect.

Filter (Cutoff) Frequency (see page 23)

The cutoff frequency of filter A/B can be controlled by the pitch/amp EG, Common keyboard tracking, controllers, or tempo. Use the 3-3: Filter1 Modulation page Filter A/B Modulation (P-FILTER> MOD) to set AMS and Intensity for Filter A or B.

- If you select M.Wheel:#01 as the AMS1 or AMS2 and set Intensity to a positive (+) value, moving the modulation wheel

away from yourself will raise the cutoff frequency, and moving it toward yourself will lower the cutoff frequency. Negative (-) settings will have the opposite effect.

- If you select the same controller as an AMS1 or AMS2 and set separate intensities for Filter A (Low Pass Filter) Intensity and Filter B (High Pass Filter) Intensity, you can use a single controller to simultaneously control the cutoff frequencies of both filters.

Resonance (see page 23)

You can use the EG, LFO, keyboard tracking, controllers, or tempo etc. to control the resonance level.

- If you select Filter KTrk or Amp KTrk as the AMS, you can use the filter or amp keyboard tracking settings to control the resonance level. For example if the amp keyboard tracking parameters Ramp BtmLo and Ramp HiTop are set to positive (+) values, Amp KTrk is selected as the AMS, and Intensity it set to a positive (+) value, playing toward either end of the keyboard will cause amp keyboard tracking to increase the volume, and AMS to raise the resonance level.
- You can select a controller as the AMS, and apply resonance when desired by using the controller.
- You can select Common LFO, LFO1 or 2 as the AMS, and use the LFO to control the resonance level.

Output (see page 23)

You can use the EG, LFO, keyboard tracking, controllers, or tempo etc. to control the output level of Filter A/B.

- Set the Filter Routing to Parallel, and specify the desired Type and other settings for Filter A and Filter B. Set the AMS to LFO for Filter A and Filter B, and set the LFO to +99 and -99 respectively. The output of Filter A and Filter B will be cyclically faded-in/out by the LFO.

Filter EG Intensity (see page 24)

Filter EG intensity can be controlled by the Common LFO, Common keyboard tracking, a controller or tempo etc. You can use Intensity to A and Intensity to B to independently specify the intensity for Filter A and B.

- If you choose JS-Y:#02 for AMS, set Intensity to A and Intensity to B as positive (+) values, and move the joystick of a synthesizer connected to the KROSS in the -Y direction, the Filter EG effect will gradually increase. If you set Intensity to A and Intensity to B to negative (-) values, the filter EG effect will be inverted.
- If you select Pitch Bend as the AMS and set Intensity to A and Intensity to B to a positive (+) value, rotating the modulation wheel away from yourself will gradually increase the effect of the Filter EG. Rotating the modulation wheel toward yourself will gradually increase the effect of the Filter EG with an inverted phase.

Filter LFO1/2 Intensity (see page 25)

The LFO 1/2 filter modulation intensity can be controlled by the EG, Common LFO, keyboard tracking, controller, or tempo etc. You can use Intensity to A and Intensity to B to independently specify the intensity for Filter A and B.

- If you select EG as the AMS, the auto-wah effect produced by LFO modulation will be controlled by the changes in EG level. If you set Intensity to A and Intensity to B to a positive (+) value, the wah effect will deepen as the EG level rises, and will lessen as the EG level falls. With negative (-) values of Intensity to A and Intensity to B, the phase of the LFO will be inverted.
- If you use a controller such as SW1 or 2 as the AMS, you can apply the auto-wah effect when desired by pressing the SW1 or SW2 switch.

Filter Common LFO (see page 25)

You can use the EG, LFO, keyboard tracking, controllers, or tempo etc. to control the Common LFO filter modulation intensity. You

can use **Intensity to A** and **Intensity to B** to specify the intensity separately for Filter A and B.

- You can set **AMS** to a controller, and use the controller only when you want to control the depth of the filter sweep produced by the Common LFO.

Amp (see page 33)

The volume can be controlled by the pitch/filter EG, Common LFO, controllers, or tempo etc.

- If an EG or controller that changes with a positive (+) value (EXT(+)) is selected as the **AMS**, setting the **Intensity** to +99 will allow you to increase the volume to a maximum of eight times that of the current volume.
- If an EG, LFO, or controller that changes with a ± value (Pitch EG, Filter EG, LFO, KT, EXT(+/-)) is selected as the **AMS**, setting the **Intensity** to +99 will allow you to increase the volume to a maximum of eight times that of the current volume (for positive (+) changes of the **AMS**), or to decrease the volume to zero (for negative (-) changes of the **AMS**).
- In addition to the time-variant changes in volume produced by the amp EG, you can also make the volume change in synchronization with the pitch/filter EG. Select Pitch EG or Filter EG as the **AMS**, and adjust **Intensity**. If you wish to cancel the effect of the Amp EG and use the pitch/filter EG to control the volume, set all levels of the Amp EG to +99.

Amp LFO1/2 Intensity (see page 33)

The amp modulation intensity of LFO 1/2 can be controlled by the EG, Common LFO, keyboard tracking, controllers, or tempo etc.

- If you select EG as the **AMS**, the depth of the tremolo effect produced by LFO modulation will change in synchronization with the changes in EG level. If you set **Intensity** to a positive (+) value, the tremolo effect will deepen as the EG level rises, and lessen as the EG level falls. If **Intensity** is set to a negative (-) value, the phase of the LFO will be inverted.
- If select a controller such as SW1 or 2 as the **AMS**, you can apply the tremolo effect by pressing the SW1 or SW2 switch when desired.

Pan (see page 32)

The oscillator pan can be controlled by the EG, LFO, keyboard tracking, controllers, or tempo etc.

- If you select Note Number as the **AMS** and set **Intensity** to +50, panning will be controlled by the keyboard position: center at the C4 note, far right at C9 or above, and far left at C-1 or below.
- If EG is selected as the **AMS**, the oscillator pan will be controlled in synchronization with the changes in EG level. If **Intensity** is set to a positive (+) value, the pan will move toward the right as the EG level increases, and toward the left as the EG level decreases. If **Intensity** is set to a negative (-) value, the opposite effect will occur.

EG Reset —

Pitch EG (see page 18)

Filter EG (see page 28)

Amp EG (see page 36)

You can use the EG, LFO, keyboard tracking, controllers, or tempo etc. to control EG Reset. Use the Threshold setting to specify the **AMS** value where result will occur.

- By setting **AMS** to Common LFO, you can reset the envelope cyclically at the interval of the Common LFO. The result is just as if the shape specified by the envelope were being used as a special LFO.
- You can reset the envelope by setting **AMS** to a controller such as JS+Y, and using the controller when desired, producing a one-shot filter envelope sweep.

EG Level —

Pitch EG (see page 19)

Filter EG (see page 29)

Amp EG (see page 37)

EG levels can be controlled by the Common LFO, keyboard tracking, controllers, or tempo etc.

You can specify an **Intensity** value for each EG segment (**Start, Attack, Break**). If you set the **Intensity** value to +66, you will be able to control the respective level over a maximum range of ±99.

- Set **AMS** to Velocity for Amp EG Level Modulation, **Intensity Start** to +00, **Attack** to +66, and **Break** to -66. Set all Amp EG levels to +00. As you play with increasing velocity, the EG levels will change more greatly. At the maximum velocity, the Start Level will stay at +00, but the Attack Level will change to +99 and the Break Level will change to -99.

EG Time —

Pitch EG (see page 20)

Filter EG (see page 30)

Amp EG (see page 38)

EG times can be controlled by the Common LFO, keyboard tracking, controllers, or tempo etc.

You can specify an **Intensity** value for each EG segment (**Attack, Decay, Slope, Release**). EG times are determined by the Alternate Modulation value when the preceding point is reached. For example, the Alternate Modulation value at the moment the envelope reaches the attack level will determine the decay time.

If **Intensity** is set to a value of 8, 17, 25, 33, 41, or 49, the corresponding time can be multiplied by a maximum of 2, 4, 8, 16, 32, or 64 times (or divided by 1/2, 1/4, 1/8, 1/16, 1/32, 1/64).

- Select M.Wheel:#01 for **AMS**, and set **AMS Intensity** to +8, **At** to +, **Dc** to -, and **SI** and **RI** to 0. When you move the modulation wheel away from yourself, the Attack Time will be lengthened by a maximum of 2 times. The Decay Time will be shortened by a maximum of 1/2. The Slope and Release times will not change.

LFO Frequency (see page 41)

The frequency of LFO 1, 2 or Common LFO can be controlled by the EG, keyboard tracking, controllers, or tempo etc.

You can also use the LFO2 frequency to modulate LFO1, or use the Common LFO frequency to modulate LFO 1/2.

If **Intensity** is set to a value of 16, 33, 49, 66, 82, or 99, the corresponding frequency can be multiplied by a maximum of 2, 4, 8, 16, 32, or 64 times (or divided by 1/2, 1/4, 1/8, 1/16, 1/32, 1/64).

- Select M.Wheel:#01 for **AMS**, and set **Intensity** to +16. When you move the modulation wheel away from yourself, the LFO frequency will be increased by a maximum of 2 times. If you set **Intensity** to -16 and move the modulation wheel away from yourself, the LFO frequency will be decreased by up to 1/2.

LFO Frequency AMS Intensity (see page 41)

You can use the EG, keyboard tracking, controllers, or tempo etc. to control the intensity of the **AMS** that controls the frequency of the LFO 1, 2, or Common LFO.

For example if you're using the pitch EG to modulate the LFO frequency, you could use a separate **AMS** to control the depth of this effect.

- Set **AMS** to a controller such as SW 1 or 2, so that the pitch EG will lightly control the LFO frequency when the switch is off, and more deeply when the switch is on.

LFO Shape (see page 42)

You can use a EG, keyboard tracking, controllers, or tempo etc. to control the shape of the LFO 1, 2, or Common LFO waveform.

You can also use the LFO2 frequency to modulate LFO1, or use the Common LFO frequency to modulate LFO 1/2.

- You can control the LFO waveform by setting **AMS** to a controller such as modulation wheel, and using the controller when desired.

Common LFO Reset (see page 43)

You can use a controller or tempo etc. to reset the Common LFO.

- By setting **AMS** to Gate 1, you can make the Common LFO reset when a note is played from a state where all notes are off. For example, this will ensure that a filter sweep always starts from the same place.
- You can set **AMS** to a controller such as M.Wheel: #01, and use the controller when you want to reset the LFO.

Dynamic Modulation Sources (Dmod)

You can control certain effect parameters using the modulation wheel, SW1/SW2, etc. “on the fly.”

These parameters can also be controlled by the sequencer.

Controlling effects in this way is referred to as Dynamic Modulation. For example, you can use After Touch to speed up the LFO of the chorus and flanger, or you can use the modulation wheel to sweep a wah effect. This lets you take full advantage of the effects as part of the expressive potential of your instrument.

Most of the parameters for dynamic modulation consist of parameter values for **Src** and **Amt**. The **Src** field selects the modulation source, and **Amt** sets the modulation intensity. When the **Src** is at its maximum value (for instance, when the modulation wheel is moved away from yourself), the actual degree of the effect will be the parameter value plus the **Amt**.

Example: Wet/Dry 10:90, Src M.Whl:#01, Amt +50

In this case, the effect balance will normally be 10:90, and moving the modulation wheel away from yourself will gradually increase the proportion of the effect sound. When the modulation wheel is moved all the way, the effect balance will be 60:40.

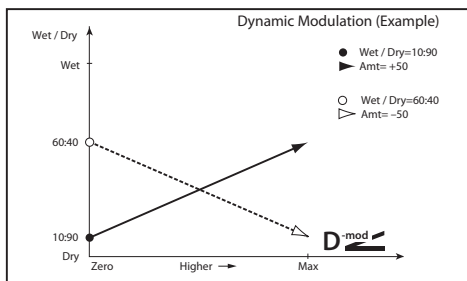

See the individual effect descriptions for explanations of other dynamic modulation parameters. Parameters that can be controlled through dynamic modulation are marked by the **D^{mod}** symbol.

Dmod and MIDI



In Program mode, dynamic modulation is always controlled via the global MIDI Channel.

In Combination and Sequencer modes, dynamic modulation is controlled via the MIDI channel independently specified by the **Ch** for IFX1–5 and MFX1, 2.

Dynamic Modulation Source List

Off	dynamic modulation is not used
Gate1	note on/off (see page 289)
Gate1+D	note on + damper on/off (see page 289)
Gate2	note on/off (retrigger) (see page 289)
Gate2+D	note on + damper on/off (retrigger) (see page 289)
NoteNum	note number
Velocity	velocity
Exp Velo	exponential velocity (see page 289)
After T	aftertouch (Channel After Touch) reception
P.Bend	Pich bend wheel (toward yourself/away from yourself)
M.Whl #1	modulation wheel (away from yourself) (CC#01)
JS-Y #2	MIDI Control Change (CC#02)
Pedal #4	assignable foot pedal (CC#04) (see page 289)
FX #12	MIDI effect control 1 (CC#12)
FX #13	MIDI effect control 2 (CC#13)
Ribon#16	MIDI Control Change (CC#16)
VSlDr#18	MIDI Control Change (CC#18) (see page 289)
K.M1 #17	MIDI Control Change (CC#17) (see page 289)
K.M2 #19	MIDI Control Change (CC#19) (see page 289)
K.M3 #20	MIDI Control Change (CC#20) (see page 289)
K.M4 #21	MIDI Control Change (CC#21) (see page 289)
K.M1 [+]	Knob modulation 1 [+](see page 289)
K.M2 [+]	Knob modulation 2 [+](see page 289)
K.M3 [+]	Knob modulation 3 [+](see page 289)
K.M4 [+]	Knob modulation 4 [+](see page 289)
Dmpr #64	damper pedal (CC#64)
PrSW #65	portamento switch (CC#65)
Sstn #66	sostenuto pedal (CC#66)
Soft #67	soft pedal (CC#67)
SW1 #80	assignable panel switch 1 (SW1 modulation CC#80) (see page 290)
SW2 #81	assignable panel switch 2 (SW2 modulation CC#81) (see page 290)
Foot #82	assignable foot switch (CC#82) (see page 293)
CC#83	MIDI Control Change (CC#83)
CC#85	MIDI Control Change (CC#85)
CC#86	MIDI Control Change (CC#86)
CC#87	MIDI Control Change (CC#87)
CC#88	MIDI Control Change (CC#88)
Tempo	tempo (internal clock or external MIDI clock tempo data) (see page 289)

Gate1, Gate1+Dmpr (Gate1, Gate1+Damper)

The effect is at maximum during note-on, and will stop when all keys are released. With Gate1 + D, the effect will remain at maximum even after the keys are released, as long as the damper (sustain) pedal is pressed.

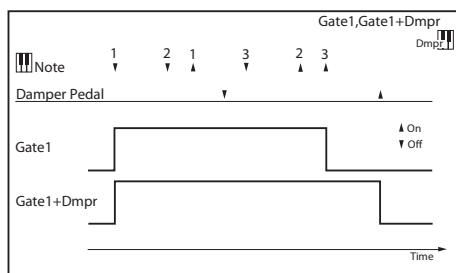

Gate2, Gate2+Dmpr (Gate2, Gate2+Damper)

This is essentially the same as for Gate 1 or Gate 1 + D. However when Gate 2 or Gate 2 + Damper are used as a dynamic modulation source for the EG of 075: St. Env. Flanger etc. or the AUTOFADE of 076 Stereo Vibrato, a trigger will occur at each note-on. (In the case of Gate 1 and Gate 1 + D, the trigger occurs only for the first note-on.)

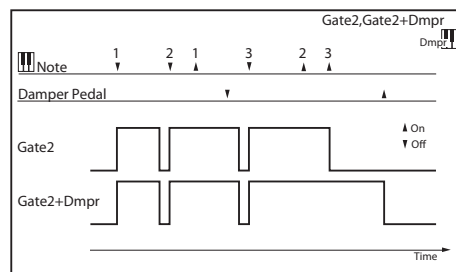

Exp Velo (Exponential Velocity)

Modulation will be applied exponentially according to the velocity value. Weak velocity values will produce little effect, but the effect will increase rapidly as the velocity values rise.

Pedal #4 (Foot Pedal: CC#04)

If you wish to use the assignable foot pedal as a dynamic modulation source, set **Foot Pedal Assign** (G-INPUT/CTRL> FOOT) to Foot Pedal (CC#04). (See “Foot Pedal Assign” on page 292)

A foot controller etc. connected to the ASSIGNABLE PEDAL jack can be used to control an effect.

K.M1 #17 (Knob Modulation1: CC#17)

K.M1 #19 (Knob Modulation2: CC#19)

K.M1 #20 (Knob Modulation3: CC#20)

K.M1 #21 (Knob Modulation4: CC#21)

The effect will be applied by the sequence data of the KROSS or by control change data received via MIDI IN. When the control change value is at the middle value of 64, the effect as a dynamic modulation source will be 0. If **Amt** is a positive (+) value, increasing the value will have an effect in the positive direction, and decreasing the value will have an effect in the negative direction. (With negative (-) values, the effect will be in the opposite direction.)

K.M1 [+] (Knob Modulation1 [+])

K.M2 [+] (Knob Modulation2 [+])

K.M3 [+] (Knob Modulation3 [+])

K.M4 [+] (Knob Modulation4 [+])

The control change values and the direction of the effect will be different than K.M1 #17–K.M1 #21. If **Amt** is a positive (+) value, the minimum control change value (0) will produce an effect of 0 as the dynamic modulation source. As you raise the value from 1–127, the effect will occur only in the positive direction. (With negative (-) values, the effect will be in the opposite direction.)

SW1 #80 (Switch Modulation 1: CC#80)

SW2 #81 (Switch Modulation 2: CC#81)

If you wish to use the SW1 or SW2 switch as a dynamic modulation source, adjust settings in Program, or Song to set the CONTROLLERS page parameter **Assign** to the following values respectively: **SW1** to SW1 Mod. (CC#80), or **SW2** to SW2 Mod. (CC#81) (see “SW1/2 Assign” on page 290).

The effect will be controlled when you use the SW1 or SW2 switch.

Foot #82 (Foot Switch: CC#82)

If you wish to use an assignable foot switch as a dynamic modulation source, set **Foot Switch Assign** (see page 164) to Foot Switch (CC#82) (see “MIDI transmission when the KROSS’s controllers are used” on page 293).

The effect will be controlled when you use a foot switch etc. connected to the ASSIGNABLE SWITCH jack.

Tempo

The resulting modulation will be zero at 120 BPM, the maximum positive value at 240 BPM, and the maximum negative value at 60 BPM.

SW1/2 Assign

You can assign the following functions to [SW1] and [SW2].

Make the **SW1** and **SW2** settings in each mode.

- Program: P-INPUT/CTRL> CONTROLLERS page (see page 5)
- Combination: C-INPUT/CTRL> CONTROLLERS page (see page 74)
- Song (Sequencer): S-INPUT/CTRL> CONTROLLERS page (see page 112)

Note: In Program mode, Combination mode, and Sequencer mode, these settings are made individually for each program, combination, and song.

SW1, SW2 Assign List

Off	No function.
SW1 Mod.: #80 SW2 Mod.: #81	Select this if you want to use a switch as an AMS or Dmod source. In this case, you must first specify the control destination. CC#80 (or CC#81) is transmitted each time the switch is turned on/off. Off: 0, On: 127)
Porta. SW: #65	Portamento is applied when you press SW1 (or SW2) to turn it on (LED lit). CC#65 is transmitted each time you turn the switch on/off. (Off: 0, On: 127)
Octave Down	One octave down alternates with the original octave setting each time you press SW1 (or SW2). (One octave down when the LED is lit)
Octave Up	One octave up alternates with the original octave setting each time you press SW1 (or SW2). (One octave up when the LED is lit)
Pitch Bend Lock	Locks the effect of the pitch bend wheel.

SW1 Mod.: #80 (SW1 Modulation: CC#80)

SW2 Mod.: #81 (SW2 Modulation: CC#81)

This function differs between SW1 and SW2; SW1 transmits CC#80, and SW2 transmits CC#81.

Porta. SW: #65 (Porta. SW: CC#65)

If **Oscillator Mode** (see page 7) is Single, turning the switch on (LED lit) will apply portamento regardless of the **Enable** (see page 17) setting; portamento will not apply when the switch is off (LED unlit).

If **Oscillator Mode** is Double, and the **Enable** setting is the same for both oscillators 1 and 2 (i.e., enabled or disabled for both oscillators 1 and 2), turning the switch on (LED lit) will apply portamento to oscillators 1 and 2; portamento will not apply to oscillators 1 and 2 when the switch is off (LED unlit).

If the **Enable** setting differs between OSC1 and 2 (i.e., if oscillator 1 is enabled and oscillator 2 disabled, or if oscillator 1 is disabled and oscillator 2 is enabled), then turning the switch on (LED lit) will apply portamento to the oscillator that is enabled; portamento will not apply to oscillators 1 and 2 when the switch is off (LED unlit).

Pitch Bend Lock

The switch will change the locked/unlocked state of the pitch bend wheel (locked when the LED is lit).

If you turn Lock on while using the pitch bend wheel, the effect will be locked at that position of the controller.

For example if SW1 Assign is set to Pitch Bend Lock, and you move the pitch bend wheel away from yourself and turn SW1 on, the pitch bend wheel effect will be locked (held) at the position where you moved it; even if you release your hand from the pitch bend wheel, the pitch bend will remain applied.

If you lock the pitch bend wheel, MIDI transmission of the corresponding controller will also stop, but reception will still occur.

Foot Switch Assign

Here you can assign the function of an assignable switch (a separately sold PS-1 or PS-3) that's connected to the ASSIGNABLE SWITCH jack.

- Create this setting in Global/Media mode G-INPUT/CTRL, FOOT **Foot SW Assign** (see page 164).

MIDI If you choose a function that includes a CC#, that MIDI control change message will be transmitted each time you turn the switch on/off. (Off: 0, On: 127)
If you choose SW1 or 2, the MIDI control change message specified by the **Panel Switch Assign** setting in each mode will be transmitted each time you turn the switch on/off. (Off: 0, On: 127)

Foot Switch Assign List

Off	The connected foot switch will have no function.
Foot Switch (CC#82)	Controls AMS or Dmod. To use this, choose Foot SW:#82 for AMS , or Foot #82 as the Dmod Src .
Portamento SW (CC#65)	Turns portamento on/off.
Sostenuto (CC#66)	Controls the sostenuto effect (only the keys (note numbers) being pressed when you turn the pedal switch on will be held).
Soft (CC#67)	Turns the soft pedal effect on/off.
Damper (CC#64)	Turns the damper pedal effect on/off.
Program Up	Selects a program or combination. If the MAIN page of any mode is displayed, the next-numbered sound will be selected. In Favorites mode, the next-numbered favorite will be selected. A bank select message and program change message will also be transmitted at this time.
Program Down	Selects a program or combination. If the MAIN page of any mode is displayed, the next-numbered sound will be selected. In Favorites mode, the next-numbered favorite will be selected. A bank select message and program change message will also be transmitted at this time.
Value Inc	Performs the same operation as pressing the ▲ button. (“Using a foot switch to select Programs” on page 20 of the Operation Guide)
Value Dec	Performs the same operation as pressing the ▼ button.
Song Start/Stop	Starts/stops the sequencer. A MIDI start or stop message will also be transmitted at this time.
Song Punch In/Out	The switch will control sequencer punch-in/punch-out in the Sequencer mode SEQ, REC page when “Recording Setup” is Manual Punch In.

Audio Recorder Start/Pause	Plays/pauses the audio recorder.
Audio Recorder REC Start/Stop	Starts/stops recording on the audio recorder.
Tap Tempo	Controls the tempo of the arpeggiator and song in real time.
ARP ON/OFF	Turns the arpeggiator on/off.
DRUM TRACK ON/OFF	Turns the Drum Track on/off.
STEP SEQ RUN	Plays/stops the step sequencer.
Mod Wheel (CC#01)	Controls the pitch bend wheel effect.
CC#02 (JS-Y)	Controls AMS or Dmod. Choose “JS-Y:#02” for AMS , or “JS-Y #2” for Dmod Src .
CC#16 (Ribbon)	Controls AMS or Dmod. To use this, choose “Ribbon #16” for AMS , or “Ribbn#16” as the Dmod Src .
SW1, SW2	Switch operations will control the effect of the [SW1] or [SW2] switches.

Portamento SW (CC#65)

If **Oscillator Mode** (see page 7) is Single, turning the switch on will apply portamento regardless of the **Enable** (see page 17) setting; portamento will not apply when the switch is off.

If **Oscillator Mode** is Double, and the **Enable** setting is the same for both oscillators 1 and 2 (i.e., enabled or disabled for both oscillators 1 and 2), turning the switch on will apply portamento to oscillators 1 and 2; portamento will not apply to oscillators 1 and 2 when the switch is off.

If the **Enable** setting differs between OSC1 and 2 (i.e., if oscillator 1 is enabled and oscillator 2 disabled, or if oscillator 1 is disabled and oscillator 2 is enabled), then turning the switch on will apply portamento to the oscillator that is enabled; portamento will not apply to the oscillator when the switch is off.

Foot Pedal Assign

Specify the function that will be controlled by an assignable pedal (separately sold XVP-10 or EXP-2) connected to the ASSIGNABLE PEDAL jack.

- Make this setting in Global/Media mode G-INPUT/CTRL, FOOT **Foot Pedal Assign** (see page 164).

 If you choose a function that includes a CC#, that MIDI control change message will be transmitted.

Foot Pedal Assign List

Off	The connected pedal will have no function.
Master Volume	Control the volume. At the same time, a universal system exclusive Master Volume message [FOH, 7FH, nn, 04, 01, vv, mm, F7H] will be transmitted, adjusting the volume of all timbres or tracks (while preserving the volume balance of their individual settings).
Foot Pedal (CC#04)	Controls AMS or Dmod. To use this, choose "Pedal #04" for AMS , or "Pedal #4" as the Dmod Src .
Portamento Time (CC#05)	Control the speed where portamento will change the pitch.
Volume (CC#07)	Control the volume of the program, the combination, or the sequencer's MIDI track.
Post IFX Pan (CC#08)	Control the pan of the signal that has passed through the insert effect.
Pan (CC#10)	Control the pan of the program, the combination's timbre, or the sequencer's MIDI track.
Expression (CC#11)	Control the volume of the program, the combination's timbre, or the sequencer's MIDI track. The volume is determined by the product of the Expression and the Volume.
FX Control 1 (CC#12)	Controls Dmod. To use this, choose FX1 #12 as the Dmod Src .
FX Control 2 (CC#13)	Controls Dmod. To use this, choose FX2 #13 as the Dmod Src .
MFX Send 1 (CC#93)	Control the send level to master effect 1 (MFX1) from the program, the combination's timbre, or the sequencer's MIDI track. At the same time, this will also control the send level to master effect 1 (MFX1) for an insert effect whose MIDI channel matches.
MFX Send 2 (CC#91)	Control the send level to master effect 2 (MFX2) from the program, the combination's timbre, or the sequencer's MIDI track. At the same time, this will also control the send level to master effect 2 (MFX2) for an insert effect whose MIDI channel matches.
Mod Wheel (CC#01)	Control the effect of the modulation wheel in the direction away from yourself.

CC#02 (JS-Y)	Controls AMS or Dmod. Choose JS-Y:#02 for AMS , or JS-Y #2 for Src .
CC#16 (Ribbon)	Controls AMS or Dmod. To use this, choose "Ribbon #16" for AMS , or "Ribbon#16" as the Dmod Src .
ARP GATE	Controls the arpeggiator's Gate .
ARP VELOCITY	Controls the arpeggiator's Velocity .
ARP SWING	Controls the arpeggiator's Swing .

MIDI transmission when the KROSS's controllers are used

The following tables show the relation between the MIDI messages that are transmitted when the KROSS's controllers are used, and the AMS (alternate modulation source) or DMS

(dynamic modulation source) that correspond to each MIDI message.

indicates a fixed function, and * indicates an assignable function.

MIDI Messages and physical controllers

MIDI messages	Pitch Bend Wheel	Modulation Wheel	SW1, 2	ARP On/Off	Damper	Foot Switch	Foot Pedal	Available for AMS	Available for Dmod
Note-off									
Note-on (note number)								*	*
Note-on (velocity)								*	*
Poly aftertouch								*	
0 Bank select (MSB)				*					
1 Modulation 1		#		*		*	*	*	*
2 Modulation 2				*		*	*	*	*
3 -				*					
4 Foot controller				*			*	*	*
5 Portamento time				*			*		
6 Data entry (MSB)				*					
7 Volume				*			*		
8 Post Insert Effect panpot				*			*		
9 -				*					
10 Panpot				*			*		
11 Expression				*			*		
12 Effect control 1				*			*		*
13 Effect control 2				*			*		*
14 ARP On/Off control				*(1)		*(1)			
15 -				*					
16 Controller (CC#16)				*		*	*	*	*
17 Knob modulation 5				*				*	*
18 Controller (CC#18)				*				*	*
19 Knob modulation 6				*				*	*
20 Knob modulation 7				*				*	*
21 Knob modulation 8				*				*	*
22 ARP-GATE control				*			*(1)		
23 ARP-VELOCITY control				*			*(1)		
24 ARP-SWING control				*			*(1)		
25 -				*					
26 -				*					
27 -				*					
28 -				*					
29 -				*					
30 -				*					
31 -				*					
32 Bank select (LSB)				*					
33...37 -				*					
38 Data entry (LSB)				*					
39...63 -				*					
64 Damper				*	#	*		*	*
65 Portamento On/Off			*	*		*		*	*
66 Sostenuto				*		*		*	*
67 Soft pedal				*		*		*	*
68...69 -				*					
70 Sustain level				*					
71 Filter resonance level				*					
72 Release time				*					
73 Attack time				*					
74 Filter cutoff frequency				*					
75 Decay time				*					
76 LFO1 speed				*					
77 LFO1 depth (pitch)				*					
78 LFO1 delay				*					
79 Filter EG intensity				*					
80 SW1 modulation On/Off			*(SW1)	*				*	*
81 SW2 modulation On/Off			*(SW2)	*				*	*
82 Foot switch On/Off				*				*	*
83 Controller (CC#83)				*				*	*
84 -				*					
85 Controller (CC#85)				*				*	*
86 Controller (CC#86)				*				*	*
87 Controller (CC#87)				*				*	*
88 Controller (CC#88)				*				*	*
89...90 -				*					
91 Effect depth 1 (send 2 level)				*			*		
92 Effect depth 2 (IFX 1-5 On/Off)				*					
93 Effect depth 3 (send 1 level)				*			*		
94 Effect depth 4 (MFX 1, 2 On/Off)				*					
95 -				*					
96 Data increment				*					
97 Data decrement				*					
98 NRPN(LSB)				*					
99 NRPN(MSB)				*					
100 RPN(LSB)				*					

MIDI messages	Pitch Bend Wheel	Modulation Wheel	SW1, 2	ARP On/Off	Damper	Foot Switch	Foot Pedal	Available for AMS	Available for Dmod
0: Bend range				*					
1: Fine tune				*					
2: Coarse tune				*					
101 RPN(MSB) 0				*					
102 -				*					
103 -				*					
104 -				*					
105 -				*					
106 -				*					
107 -				*					
108 -				*					
109 -				*					
114 -				*					
115 -				*					
116 -				*					
117 -				*					
118 -				*					
119 -				*					
Program change									
Channel aftertouch								*	*
Pitch Bend	+X, -X							*	*
Universal system exclusive									
Master volume							*		
Master balance									
Master fine tune									
Master coarse tune									

*: Assignable

(1): With the default CC# assignment of the ARP controller (G-INPUT/CTRL> CC page).

These CC#s are enabled if the G-MIDI> OUT page setting ARP Controllers MIDI Out is set to Control Change.

Normally, you'll use these default CC#s when assigning a CC# to the ARP SW.

#: When you use the controller of the KROSS, the corresponding or assigned control change will be transmitted. For example, pitch bend will be transmitted only when you use the pitch bend wheel.

When one of the KROSS's controllers is used, the corresponding or the assigned control change will be transmitted.

The following sections describes operation in each mode.

Program mode

When one of the KROSS's controllers is used, a control change message will be transmitted on the global MIDI channel (**MIDI Channel** see page 159).

 If the assignable pedal are assigned to Master Volume, the universal system exclusive message Master Volume will be transmitted.

Combination mode

When one of the KROSS's controllers is used, a control change message will be transmitted on the global MIDI channel (**MIDI Channel** see page 159).

Simultaneously, the message will also be transmitted on the MIDI channel (**MIDI Channel C-TIMBRE> MIDI**) of any timbre where the **Status** (see page 71) is EXT or EX2.

When one of the KROSS's controllers is used, its effect will apply to any timbre where the **Status** is INT and where **MIDI Channel** setting is either Gch or the same as the global MIDI channel.

 In the case of Master Volume, the universal exclusive message Master Volume will be transmitted only on the global MIDI channel.

 You can adjust settings for MIDI Filter (see page 82) to enable or disable control changes and controllers for each timbre. When checked, the above operations will be enabled.

Effect dynamic modulation can be controlled when the **Ch** (see page 92) setting for IFX1-5, MFX1, or 2 is either set to Gch or to the same channel as the global MIDI channel. (In the case of All

Routed, control is possible on the MIDI channel of any routed timbre.)

Sequencer mode

When one of the KROSS's controllers is used, its effect will apply to the MIDI track 1-16 that is currently selected by **Track Select** (see page 104).

If the **Status** (see page 116) of the track selected by **Track Select** is EXT, EX2, or BTH, a control change message will be transmitted on the MIDI channel specified by **MIDI Channel** (see page 116).

If the **Status** is INT or BTH, using one of the KROSS's controllers will affect only that MIDI track. Simultaneously, the same effect will also apply to any MIDI track with the same **MIDI Channel** setting.

 In the case of Master Volume, the universal exclusive message Master Volume will be transmitted.

 You can adjust settings for MIDI Filter (S-MIDI FILTER) to enable or disable control changes and controllers for each track. When checked, the operations effective for a **Status** of INT or BTH will be enabled. Tracks whose **Status** is EXT, EX2, or BTH will transmit control changes regardless of this setting.

Effect dynamic modulation can be controlled when the **Ch** (S-IFX) setting for IFX1-5 or MFX1, 2 matches the MIDI channel of the track selected by **Track Select**. (In the case of All Routed, control is possible on the MIDI channel of all routed tracks.)

If one of the KROSS's controllers is used during realtime recording, the corresponding or assigned control change will be recorded.

KROSS and MIDI CCs

Responses to standard MIDI controllers

The following table shows how the KROSS responds to MIDI control change messages, and the relation between settings and controller movements on the KROSS.

CC#	Control	Value	Function
0	Bank select (MSB)	0...127	bank select message MSB *1
1	Modulation 1	0...127	corresponds to modulation wheel movement aware from yourself
2	Modulation 2	0...127	for controlling Alternate Modulation Source (AMS: corresponds to JS-Y #02) or Effect Dynamic Modulation (Src: corresponds to JS-Y #02))
3	–	–	–
4	Foot controller	0...127	corresponds to when the assignable pedal function is set to Foot Pedal
5	Portamento time	0...127	portamento time
6	Data entry (MSB)	0...127	MSB of RPN and NRPN data *2
7	Volume	0...127	volume *3
8	Post Insert Effect panpot	0...127	pan after the Insert Effect
9	–	–	–
10	Panpot	0...127	pan
11	Expression	0...127	volume *3
12	Effect control 1	0...127	corresponds to effect dynamic control source FX Control1 (see page 302)
13	Effect control 2	0...127	corresponds to effect dynamic control source FX Control2 (see page 302)
14	ARP ON/OFF control	0...63(Off), 64...127(On)	equivalent to on/off when CC#14 is assigned to the ARP buttons *7
15	–	–	–
16	Controller (CC#16)	0...127	for controlling Alternate Modulation Source (AMS: corresponds to CC#16) or Effect Dynamic Modulation (Src: corresponds to CC#16)
17...21	–	–	–
22	ARP–GATE control	0...127	equivalent to when CC#22 is assigned to arpeggio control 1 (GATE) *7
23	ARP–VELOCITY control	0...127	equivalent to when CC#23 is assigned to arpeggio control 2 (VELOCITY) *7
24	ARP–SWING control	0...127	equivalent to when CC#24 is assigned to arpeggio control 3 (SWING) *7
26...31	–	–	–
32	Bank select (LSB)	0...127	LSB of bank select message *1
33...37	–	–	–
38	Data entry (LSB)	0...127	LSB of RPN or NRPN data *2
39...63	–	–	–
64	Damper	0...127	damper effect
65	Portamento On/Off	0...63(Off), 64...127(On)	turn the portamento effect on/off
66	Sostenuto On/Off	0...63(Off), 64...127(On)	turn the sostenuto effect on/off
67	Soft	0...127	soft pedal effect
68...69	–	–	–
70	Sustain level	0...127	sustain levels of the filter EG and amp EG *4
71	Filter resonance level	0...127	resonance level of the filter *4
72	Release time	0...127	cutoff frequency of the high pass filter *4
73	Attack time	0...127	release times of the filter EG and amp EG *4
74	Filter cutoff frequency	0...127	cutoff frequency of the low pass filter *4
75	Decay time	0...127	decay times/slope times of the filter EG and amp EG *4
76	LFO1 speed	0...127	LFO1 speed *4
77	LFO1 depth	0...127	pitch LFO1 intensity *4
78	LFO1 delay	0...127	LFO1 delay *4
79	Filter EG intensity	0...127	filter EG intensity *4
80	SW1 modulation On/Off	0...63(Off), 64...127(On)	corresponds to on/off when the SW1 function is set to SW1 Mod.
81	SW2 modulation On/Off	0...63(Off), 64...127(On)	corresponds to on/off when the SW2 function is set to SW2 Mod.
82	Foot switch On/Off	0...63(Off), 64...127(On)	corresponds to on/off when the function of the assignable foot switch is set to Foot SW
83	Controller (CC#83)	0...127	for controlling AMS or Dmod
84	–	–	–

CC#	Control	Value	Function
85...88	Controller (CC#85...88)	0...127	for controlling AMS or Dmod
89, 90	–	–	–
91	Effect depth 1 (send 2 level)	0...127	send 2 level
92	Effect depth 2 (Insert Effect 1–5 On/Off)	0...63(Off), 64...127(On)	turn Insert effect 1...5 on/off *5
93	Effect depth 3 (send 1 level)	0...127	send 1 level
94	Effect depth 4 (master effect 1, 2 On/Off)	0...63(Off), 64...127(On)	master effect 1, 2 on/off *5
95	–	–	–
96	Data increment	0	
97	Data decrement	0	
98	NRPN(LSB)	–	LSB of NRPN
99	NRPN(MSB)	–	MSB of NRPN
100	RPN(LSB)	0	selects the pitch bend range *2
		1	controls Fine Tune *2
		2	controls Coarse Tune *2
101	RPN(MSB)	0	MSB of RPN
102...119	–	–	–

You can assign any control change number (CC#00–119) to the ARP control. In this case, buttons will transmit values of 0 (Off) or 127 (On).

*1 In the KROSS sequencer, bank select messages are normally specified as program change events (“MIDI Event Edit”). However in some cases this will be insufficient when you wish to change banks on an external device. In such cases, you can use CC#00 and CC#32 to specify the banks. For information on the relation between bank select numbers and the banks of your external device, refer to the owner’s manual for your external device.

*2 Unlike conventional control changes, pitch bend range, fine tune, and coarse tune settings are made using RPC (Registered Parameter Control) messages. In Program, Combination, and Sequencer modes, you can use RPC messages to control the bend range and tuning for each program, Timbre (Combination), or Track (Sequencer).

The procedure is to use an RPN (Registered Parameter Number) message to select the parameter that you wish to edit, and then use Data Entry to input a value for that parameter. To select the parameter, use CC#100 (with a value of 00...02) and CC#101 (with a value of 00). use CC#06 and CC#38 to enter the data.

The data entry values for each parameter and the corresponding settings are as follows.

RPN=0 (Pitch bend range)

CC#06	CC#38	Parameter value (Semitone steps)
0	00	0
⋮	⋮	⋮
12	00	+12
⋮	⋮	⋮
24	00	+24
⋮	⋮	⋮
127	00	+24

RPN=1 (Fine tune)

CC#06	CC#38	Parameter value (1 cent steps)
0	00	-100
⋮	⋮	⋮
64	00	0
⋮	⋮	⋮
127	00	+98
⋮	⋮	⋮
127	127	+99

RPN=2 (Coarse tune)

CC#06	CC#38	Parameter value (Semitone steps)
0	00	-24
⋮	⋮	⋮
40	00	-24
⋮	⋮	⋮
64	00	0
⋮	⋮	⋮
88	00	+24
⋮	⋮	⋮
127	00	+24

For example, if in Sequencer mode you wish to set a MIDI track that is receiving channel 1 to a transpose (coarse tuning) value of -12, you would first transmit [B0, 64, 02] (64H=CC#100) and [B0, 65, 00] (65H=CC#101) to the KROSS to select the RPN coarse tune. Then you would set this to -12 by transmitting [B0, 06, 34] (06H=CC#6), 34H=52 (corresponds to -12), and [B0, 26, 00] (26H=CC#38, 00H=0).

*3 The volume of the KROSS is determined by multiplying the Volume (CC#07) with the Expression (CC#11). In Sequencer mode when you stop the song playback and return the location to the beginning of the track, the Volume will be set to the starting value, and the Expression will be set to the maximum value (127).

*4 A value of 64 will correspond to the value specified by the program parameter. 0 is the minimum, and 127 is the maximum. Changing from 63–1 or from 65–126 will adjust the effect from the program parameter setting toward the minimum

value or maximum value.

- For details about the specific parameters controlled by these CCs, please see “Parameters controlled by MIDI CCs #70-79” below.

*5 Controlled on the global MIDI channel.

*6 If you assign a CC# to the ARP control and perform these operations on the KROSS, the assigned CC# will be transmitted, and the KROSS itself will also be controlled at the same time. If this message is received, the result will be the same as if the KROSS itself had been used.

The CC# settings for each Knob parameters and button are made in the G-MIDI> CC page. Use these settings if you need to assign control change messages, for example when you want to record button usage on the internal sequencer or an external MIDI sequencer, or to control the arpeggiator from an external MIDI device.

Each ARP Controls and button can be assigned to any desired MIDI control change message CC#00–119, but normally you will use the CC Default settings.

This table shows the operations for the CC Default settings. The CC Default settings are the CC#s recommended for use with these controllers. Normally, you will assign these CC#s.

Parameters controlled by MIDI CCs #70-79

CC#70–79 correspond to the KROSS’s program parameters listed below.

In Program mode, the corresponding program parameters will be temporarily edited when CC#70–79 messages are received on the global MIDI channel (**MIDI Channel G-MIDI> BASIC**).

In most cases, you can use the **Write Program** function to save the edited values, over-writing the previous Program settings.



When these control changes are received in Combination (Sequencer) mode, they will affect the program parameters of the timbre (track) whose MIDI channel matches the channel of the message. However, that state cannot be directly saved as a program.

CC#	Internal parameters controlled by the CC
70 (Sustain level)	Filter EG 1/2 Sustain (see page 29) Amp EG 1/2 Sustain (see page 36)
71 (Filter resonance)	Filter A/B, 1/2 Resonance (see page 22)
72 (Release time)	Filter EG 1/2 Release (see page 29) Amp EG 1/2 Release (see page 36)
73 (Attack time)	EG Times: Filter EG 1/2 Attack (see page 28) Amp EG 1/2 Attack (see page 36) Amp EG 1/2 Time Modulation: Attack (see page 37) EG Levels: Amp EG 1/2 Level Start (see page 36) Amp EG 1/2 Level Attack (see page 36) Amp EG 1/2 Level Modulation: Start (see page 36)
74 (Filter cutoff frequency)	Filter A/B, 1/2 Freq (Cutoff Frequency) (see page 22)
75 (Decay time)	Filter EG 1/2 Dcy/Brk (Decay) (see page 28) Filter EG 1/2 Slp/Sus (Slope) (see page 28) Amp EG 1/2 Dcy/Brk (Decay) (see page 36) Amp EG 1/2 Slp/Sus (Slope) (see page 36)
76 (LFO1 speed)	LFO 1 Frequency (see page 41)
77 (LFO1 Pitch intensity)	Pitch LFO1 Intensity (see page 16)
78 (LFO1 delay)	LFO 1 Delay (see page 40)
79 (Filter EG intensity)	Filter EG 1/2 Intensity to A (see page 24) Filter EG 1/2 Intensity to B (see page 24)

MIDI applications

About MIDI

MIDI stands for Musical Instrument Digital Interface, and is a world-wide standard for exchanging various types of musical data between electronic musical instruments and computers. When MIDI cables are used to connect two or more MIDI devices, performance data can be exchanged between the devices, even if they were made by different manufacturers.

Settings when connected to a MIDI device or computer

Here we will explain the settings you'll make on the KROSS when connecting it to another device.

The "Convert Position" setting

The KROSS's settings **Key Transpose**, **Velocity Curve**, and **After Touch Curve (MIDI IN)** (see page 156) respectively allow you to adjust the transposition, velocity sensitivity, and aftertouch (received only from the internal sequencer or from MIDI IN) sensitivity.



The aftertouch curve is applied only to data received from the internal sequencer or from MIDI IN. The **After Touch Curve (MIDI IN)** setting does nothing if **Convert Position** (see page 160) is Pre-MIDI.

The effect that these settings will have on the internal sequencer and on the MIDI data that is transmitted and received will depend on **Convert Position** setting.

- If you want to control an external MIDI tone generator from the KROSS, set **Convert Position** to PreMIDI. The various settings listed above will be reflected in the MIDI data that is transmitted. These settings will also be reflected in the data that is recorded on the internal sequencer.

Incoming MIDI data will be handled with settings equivalent to **Key Transpose 0**, **Velocity Curve 4**, and **After Touch Curve 3**.

- When controlling the KROSS's tone generator from an external MIDI device, select PostMIDI. The above-listed settings will affect the MIDI data that is received. These settings will also affect the data that is played back from the internal sequencer.

Outgoing MIDI data will be handled with settings equivalent to **Key Transpose 0**, and **Velocity Curve 4**.

Local Control On settings

If you've connected the KROSS to a computer or external MIDI sequencer and want to use the "echo-back" from that device to play the KROSS, turn echo-back on for your external MIDI sequencer or computer (so that the data it receives at MIDI IN will be retransmitted from MIDI OUT), and turn off the KROSS's local control setting (so that the KROSS's keyboard section and sound generator will be internally disconnected).

When you play the keyboard of the KROSS, the musical data will be transmitted to the external MIDI sequencer or computer, and then echoed back to play the KROSS's tone generator. In other words, by turning Local Control OFF, you can prevent notes from being sounded in duplicate, as would otherwise occur if a note were sounded by the KROSS's own keyboard and again by the data that was echoed-back.

If the arpeggiator function is on, playing the KROSS's keyboard will not cause the arpeggiator to run, and only the musical data produced by playing the keyboard will be transmitted. The arpeggiator will run only in response to the notes that are echoed-back and received at MIDI IN. In this way, turning off Local Control prevents the arpeggiator from running in duplicate.

Select this setting when you wish to record on the external MIDI sequencer or computer using only the notes that trigger the arpeggiator, and to use the echoed-back notes to use the arpeggiator while monitoring your recording or during playback.

Note: If you want the note data produced by the arpeggiator to be recorded on the external sequencer/computer, set Local Control on, and turn off the Echo Back setting of the external sequencer/computer.

To turn off Local Control, press the **Local Control On** (see page 160) check box to uncheck it.

When using the KROSS by itself, leave Local Control turned on. (If this is off when the KROSS is used by itself, playing the keyboard will not produce sound.)

Messages transmitted and received by the KROSS

In the text below, [...] indicates hexadecimal notation.

MIDI channels

MIDI messages can be exchanged when the transmitting and receiving devices are set to the same MIDI channel. MIDI uses sixteen channels, numbered 1–16. The way that channels are handled will differ depending on the mode.

Program mode

- Other than transmission for the Drum Track function and Step sequencer, all data is transmitted and received on the global MIDI channel.

The global MIDI channel is the basic channel that the KROSS uses for MIDI transmission/reception, and is set by **MIDI Channel** (see page 159).

- The Drum Track function in Program mode will transmit and receive on the following MIDI channels.

Receive: Global MIDI channel.

Transmit: The MIDI channel specified by the Drum Track **Prog MIDI Out** (see page 161) setting (default: channel 10).

Note: Transmission is enabled if Drum Track **Prog MIDI Out** (G–MIDI> OUT) is checked. By default, this is off (unchecked).

- Step sequencer functions in Program mode are transmitted and received using the following MIDI channel.
Transmission and reception: The MIDI channel specified by “Step Seq **Prog MIDI Ch**” (see page 162) (default: channel 16)

Note: Transmission is enabled if Step Seq “Prog MIDI Out” (see page 162) is selected. By default, this is off (not selected).

Note: Reception is enabled if the “Assign Inst to Tone” function’s dialog box is open. The drum program of the step sequencer will sound.

Combination mode

- The global MIDI channel is used to transmit/ receive messages for selecting a combination and turning effects on/off, and to transmit/receive exclusive data.

- Each timbre will transmit/receive MIDI data on the **MIDI Channel** (see page 77) that is specified for that timbre.

- The Drum Track function will transmit and receive on the following MIDI channels.

Receive: Global MIDI channel. The KROSS’s keyboard will control triggering.

Transmit: The MIDI channel specified by the Drum Pattern **Output** (see page 87) setting of each combination. Set this to match the MIDI channel of a timbre to which a drum program is assigned.

- The step sequencer will use timbre 16 if the **STEP SEQ On/Off** parameter is selected. Transmission and reception will use the **MIDI Channel** (see page 159) specified for timbre 16.
- The MIDI channel specified for each effect (see page 77) is used to control dynamic modulation of the insert/master effect, the pan following the insert effect, and send 1 and 2.
- When you use the keyboard or controllers of the KROSS, messages will be transmitted on the global MIDI channel, and will also be transmitted on the MIDI channel of any timbre whose **Status** (see page 71) is set to EXT or EX2.
- Channel messages will be received if they match the MIDI channel of a timbre whose **Status** is set to INT.

Sequencer mode

- The global MIDI channel is used to transmit/ receive exclusive data and for messages that switch effects on/off.
- MIDI data transmission/reception for each MIDI track will occur on the MIDI channel specified for each MIDI track by **MIDI Channel**.

- The Drum Track function will transmit and receive on the following MIDI channels.

Receive: The MIDI channel specified by the Drum Pattern **Input** (see page 128) setting of each song. You will normally set this to Tch and use the KROSS’s keyboard to control triggering.

Transmit: The MIDI channel specified by the Drum Pattern **Output** (see page 128) setting of each song. Set this to match the MIDI channel of the MIDI track to which a drum pattern is assigned.

- The step sequencer will use track 16 if the **STEP SEQ On/Off** parameter is selected. Transmission and reception will use the **MIDI Channel** (see page 116) specified for track 16.
- The MIDI channel specified for each effect by the **Ch** parameter (S–IFX) is used to control dynamic modulation of the insert/master effect, the pan following the insert effect, and send 1 and 2.
- When you use the keyboard or controllers of the KROSS, messages will be transmitted on the MIDI channel selected by **Track Select** (SEQ>MAIN). However, messages will be transmitted only if the selected MIDI track has a **Status** of BTH, EXT, or EX2. For more information, please see the “Track Select” section on page 104.
- When the sequencer is played back, musical data of MIDI tracks where the **Status** is set to BTH, EXT, or EX2 will be transmitted on the specified MIDI channels.
- MIDI tracks where the **Status** is set to INT or BTH will receive channel messages of the matching MIDI channel. For more information, please see “MIDI Channel” on page 116, and “MIDI Channel” on page 116.

Note on/off

Note-on [9n, kk, vv]

Note-off [8n, kk, vv]

(n: channel, kk: note number, vv: velocity)

When you play a note on the KROSS’s keyboard, it will transmit note-on/off messages.

When the arpeggiator is running, note-on/off messages generated by the arpeggiator are transmitted. If Local is Off, note-on/off messages generated by the arpeggiator will not be transmitted. (see “Local Control On settings” on page 298)

If the Drum Track **Prog MIDI Out** setting (see page 161) is checked, the drum track pattern will transmit note-on/off messages while the drum track function is running.

When the step sequencer is running, note-on/off messages for the step sequencer pattern will be transmitted if Step Seq **Prog MIDI Out** (see page 162) is selected.

Note: If you turn on a key that is not selected by Group in the step sequencer function **Assign Inst to Tone** dialog box, and which therefore does not produce sound, the note-off will be transmitted with a velocity value of zero.

However, most instruments do not receive or transmit note-off velocity, and neither does the KROSS.

Program Change/Bank Select

Changing the program/bank

Program change [Cn, pp]

(n: channel, pp: program number that allows 128 sounds to be selected)

- Programs 000–127 in banks A–U correspond to program changes [Cn, 00]–[Cn, 7F].
- Programs 001–128 in banks GM, g(1), g(2), g(3), g(4), g(5), g(6), g(7), g(8), g(9), and g(d) correspond to program changes [Cn, 00]–[Cn, 7F].

Bank select MSB (CC#0) [Bn, 00, mm]

Bank select LSB (CC#32) [Bn, 20, bb]

(n: channel, mm: bank number upper byte, bb: bank number lower byte)

- The internal banks that correspond to each bank select number will depend on the **Bank Map** setting (GLOBAL> PREF). KORG is the default setting. For more information, please see the “Bank Map” section on page 158.

Simply receiving a Bank Select message will not cause the program or bank to change. The program or bank will actually change when a Program Change message is received.

Program mode

- In PROG> MAIN–ARP pages, these messages will transmit and receive program change and bank select operations. They will not be received in other pages.

Note: Drum track programs and Step sequencer programs do not support transmission or reception of program change or bank select messages.

Combination, Sequencer modes

- Program change and bank select messages can be received on the MIDI channel specified for each timbre/MIDI track to select programs on that timbre/track.
- When you select a combination, program change and bank select messages will be transmitted by timbres where the **Status** is EXT or EX2.

In Sequencer mode, program change or bank select messages will be transmitted by tracks where the **Status** is BTH, EXT, or EX2 when you select the **Program Select** parameter, when you select a song, or when you return to the beginning of a measure. For more information, please see the “PIANO...USER: 000...127” section on page 105.

- In Combination and Sequencer modes, transmission/reception can be switched on/off for each timbre/track. See “Enable Program Change” on page 82, and Global/Media mode G–MIDI> OUT “Track MIDI Out” on page 161.

Selecting combinations

You can use program change and bank select messages to select combinations in the same way that you select programs.

- Combinations 000–127 in banks A–U correspond to program changes [Cn, 00]–[Cn, 7F].
- Similarly as for program banks, the internal banks that correspond to each bank select number will depend on the **Bank Map** setting. For more information, please see the “Bank Map” section on page 158.
- In COMBI> MAIN–ARP pages, program change and bank select messages are transmitted/received on the global MIDI channel. They are not received in other pages.

Note: All program changes can be turned off in **MIDI Filter** (see page 82).

As needed, you can independently turn all program changes on/off, specify whether or not incoming messages will be able to

change combinations, and turn reception/transmission of bank select messages on/off.

- If **Combination Change** (see page 162) is unchecked, the combination will not change even if a program change on the global MIDI channel is received in COMBI page. In this case, the program of the timbre that matches the MIDI channel of the received message will change.
- If **Bank Select** (see page 162) is unchecked, bank select messages will not be transmitted or received.

Aftertouch

Channel aftertouch [Dn, vv]

(n: channel, vv: value)

When this message is received, the aftertouch effect will be applied. The assigned alternate modulation or dynamic modulation effect will also be applied.

 The keyboard of the KROSS itself cannot transmit aftertouch. Aftertouch can be received only from the internal sequencer or from MIDI IN.

- Aftertouch reception for the entire instrument can be turned on/off in **Enable After Touch**. (see page 163)
- In Combination and Sequencer modes, aftertouch can be turned on/off independently for each timbre/track (**Enable After Touch** see page 82, 122).

Polyphonic aftertouch [An, kk, vv]

(n: channel, kk: note number, vv: value)

There is another type of aftertouch called Polyphonic Key Pressure, which allows aftertouch to be applied independently for individual keys. This message can be used as an alternate modulation source, but cannot be transmitted by the KROSS’s keyboard. In order to use this message, it will have to be received from an external device, or recorded on your sequencer.

The aftertouch mentioned in this manual refers to Channel After Touch.

Pitch bend

Pitch bend change [En, bb, mm]

(n: channel, bb: lower byte of the value, mm: upper byte of the value, together expressing a value of 16,384 steps where 8,192 [bb, mm = 00H, 40H] is the center value)

When the KROSS’s pitch bend wheel is moved away from yourself, a pitch bend effect will be applied, and pitch bend messages will also be transmitted. When these messages are received, a pitch bend effect will be applied.

The range of pitch change that is produced by pitch bend messages can also be adjusted via MIDI. (see “Changing the pitch bend range” on page 304)

Control change

[Bn, cc, vv]

Transmitted and received as (n: channel, cc: control change no., vv: value)

For more information, please see “MIDI transmission when the KROSS’s controllers are used” on page 293, and “KROSS and MIDI CCs” on page 295.

- Control changes can be turned on/off as a whole in **Enable Control Change** (see page 163).
- In Combination and Sequencer modes, the MIDI FILTER settings allow transmission/reception of control changes to be individually turned on/off for each timbre/track. For the assignable controllers (SW1, SW2, and Foot Pedal/Switch), MIDI filter settings will apply to the control change number to which each controller is assigned. **Other CC Messages** applies to control changes that are not covered by the items of the other check boxes.
- You can also assign a control change to ARP Controllers. In ARP Controllers MIDI Out (see page 162), choose Control Change and use the CC page (see page 165) to assign a control change. Normally you'll use the default setting.

Selecting program/combination banks

Bank select (CC#00, CC#32)

Technically, Bank Select is a controller. In practice, however, it is a component of Program Change. For more information, please see “Program Change/Bank Select” on page 300

Using the modulation wheel to apply modulation

Modulation 1 depth (CC#01) [Bn, 01, vv]

When you move the KROSS’s modulation wheel, Modulation 1 Depth messages will be transmitted. When these messages are received, the same effect will be applied as when the KROSS’s modulation wheel is used. Normally this will apply a vibrato effect (pitch LFO).

- In Combination and Sequencer modes, transmission/reception can be turned on/off for each timbre/track (**Enable Mod.Wheel#01** see page 82, 122).

Modulation 2 depth (CC#02) [Bn, 02, vv]

If the above CC# is specified as the ASSIGNABLE PEDAL function, using the KROSS will transmit Modulation 2 Depth. If this message is received, the same effect will be applied as when the controller is used. Normally a wah effect (filter LFO) will be applied.

- In Combination and Sequencer modes, transmission/reception can be turned on/off for each timbre/track (**Enable JS-Y CC#02** see page 82, 122).

Other manufacturers use this message for other purposes (e.g., breath controller, etc.)

Controlling portamento

Portamento time (CC#05) [Bn, 05, vv]

If you assign the above CC# to an Assignable Pedal, using that pedal will transmit Portamento Time messages, and will modify the speed where the portamento pitch changes. When this message is received, the result will be the same as when the controller is used.

Portamento switch (CC#65) [Bn, 41, vv]

When the above CC# is assigned to SW1, SW2 or the Assignable Switch, using that switch will transmit vv=127 [7F] for ON or vv=0 [00] for OFF, and the portamento effect will be switched on/off. When this message is received, the result will be the same as

when the controller is used. (vv of 63 [3F] or less will be OFF, and 64 [40] or greater will be ON.) (see “SW1/2 Assign” on page 290)

- In Combination and Sequencer modes, transmission/reception of this message can be turned on/off independently for each timbre/track (**Enable Portamento SW C/ S-MIDI FILTER>1**).
- In Sequencer mode, portamento time/switch messages will be transmitted by each track where the **Status** is BTH, EXT, or EX2 when you set **Portamento** (S-TRACK> OSC, re-select a song or SMF, or return to the beginning of a measure. For more information, please see the “Portamento” section on page 116.

Controlling volume

Volume (CC#07) [Bn, 07, vv]

When the above CC# is assigned to the Assignable Pedal, using that pedal will transmit Volume messages, and the volume will change. When this message is received, the result will be the same as when the controller is used.

Expression (CC#11) [Bn, 0B, vv]

When the above CC# is assigned to the Assignable Pedal, using that pedal will transmit Expression messages, and the volume will change. When this message is received, the result will be the same as when the controller is used.

The volume of the KROSS is determined by multiplying the value of the Volume message with the value of the Expression message.

If adjusting the Volume message does not increase the volume as you expect, or if there is no sound, transmit MIDI messages from an external device to reset the value of the Expression message (set vv to 127).

Note: In Sequencer mode, this will be reset when the **Location** of the song is moved to 001:01.000.

- In Combination mode, Volume messages will be transmitted by each timbre where the **Status** is EXT or EX2 when you re-select the combination.
- When you change the **Volume** setting (SEQ> MIX) in Sequencer mode, or when you re-select the song or return to the beginning of the song in Sequencer mode, volume messages will be transmitted by each track where the **Status** is BTH, EXT, or EX2. See GLOBAL G-MIDI> OUT “Track MIDI Out” on page 161.

Note: Regardless of the **Status** settings, re-selecting a song, or returning to the beginning will reset the internal Volume value to the value specified by each track (the starting settings), and will reset the Expression value to the maximum.

Note: This message can be used to control the volume of each MIDI track. Normally, you will include a Volume message in the MIDI track setting data (the settings at the beginning of the track) to set the initial volume, and use Expression to create changes in dynamics as the song progresses.

By using the universal exclusive Master Volume message, you can adjust the overall volume without changing the volume balance between timbres or tracks. (“About system exclusive messages” on page 304)

Controlling pan (stereo position)

Pan (CC#10) [Bn, 0A, vv]

(vv: value, where 00 is far left, 64 is center, and 127 is far right)

When the above CC# is assigned to the Assignable Pedal, using that pedal will transmit Pan messages, and the panning will change. When this message is received, the result will be the same as when the controller is used.

- When you set the **Pan** (SEQ> MIX) in Sequencer mode, or when you re-select the song or return to the beginning of the measure in Sequencer mode, Panpot messages (except for RND) will be transmitted by each track where the **Status** is

BTH, EXT, or EX2. See “Pan” on page 106, GLOBAL G-MIDI> OUT “Track MIDI Out” on page 161.

Post insert effect pan (CC#08) [Bn, 08, vv]

(vv: value, where 00 is far left, 64 is center, and 127 is far right)

When the above CC# is assigned to the Assignable Pedal, using that pedal will transmit Post Insert Effect Panpot messages, and the panning of the sound following the insert effect will change. When this message is received, the result will be the same as when the controller is used.

- In Program mode, this message is transmitted/received on the global MIDI channel. In Combination, and Sequencer modes, this message is transmitted/received on the MIDI channel specified for each insert effect.
- When you set **Pan: #8** (S-FX ROUTING> MIXER) in Sequencer mode, or when you re-select the song or return to the beginning of the measure in Sequencer mode, Post Insert Effect Panpot messages will be transmitted by each track whose **Status** is BTH, EXT, or EX2. For more information, please see the “10-3: IFX (Insert FX Setup)” section on page 133.

Controlling effects

Effect control 1 (CC#12) [Bn, 0C, vv]

Effect control 2 (CC#13) [Bn, 0D, vv]

When the above CC# is assigned to the Assignable Pedal, using that pedal will transmit Effect Control 1/2 messages, and the specified dynamic modulation will be controlled. When this message is received, the result will be the same as when the controller is used.

Although various types of control change can be selected as dynamic modulation sources, Effect Control 1 (CC#12) and 2 (CC#13) are dedicated for dynamic modulation.

Effect 1 depth (Send 2) (CC#91) [Bn, 5B, vv]

Effect 3 depth (Send 1) (CC#93) [Bn, 5D, vv]

When the above CC# is assigned to the Assignable Pedal, using that pedal will transmit Effect 1 Depth (Send 2) or Effect 3 Depth (Send 1) messages, and the send level 1 or 2 to the master effects MFX1 or MFX2 will be controlled respectively. When this message is received, the result will be the same as when the controller is used.

On the corresponding MIDI channels, this will simultaneously control the timbre/track setting as well as the setting following the Insert Effect.

- In Combination, and Sequencer modes, the actual send level of the timbre/track is determined by multiplying this value with the send 1/2 settings for each oscillator (P-FX ROUTING> SEND). (See “Send 1 (MFX1),” “Send 2 (MFX2)” on page 91, GLOBAL G-MIDI> OUT “Track MIDI Out” on page 161)
- When you adjust **Send 1 (MFX1)** or **Send 2 (MFX2)** (S-FX ROUTING> SEND) in Sequencer mode, or when you re-select a song or return to the beginning of the measure in Sequencer mode, Send 1/2 will be transmitted by each track where the **Status** is BTH, EXT, or EX2. (see “Send1 (MFX1)” on page 132).

Effect 2 depth (IFX1-5 on/off) (CC#92) [Bn, 5C, vv]

Effect 4 depth (MFX1, 2 on/off) (CC#94) [Bn, 5E, vv]

Separately from the effect on/off settings in each mode, **Effect Global SW** (GLOBAL> SYSTEM) allows you to turn off insert effects IFX1-5 and master effects MFX1, 2. Master effects MFX1/2 can also be turned off using the front panel MASTER FX button.

If you uncheck **Enable IFX1-5**, or **Enable MFX1&2**, the corresponding message will be transmitted with vv=0 [00]. If you check these settings, the corresponding message will be transmitted with vv=127 [7F]. If you uncheck these settings, the corresponding effect(s) will be turned off as a group. If you check these settings, the on/off settings of each mode will be used. The same applies to reception. (vv of 00 is off, and 01 or greater is the original setting.) These messages are transmitted/received on the

global MIDI channel. (“IFX 1-5 on/off” - “MFX 1, 2 on/off” on page 60, page 62)

Note: These messages are defined simply for use in adjusting the effect levels, and may not have the same function on another instrument connected to the KROSS.

Using various controllers

Here we will explain typical ways to use the various controllers.

Foot controller (CC#04) [Bn, 04, vv]

If the above CC# is assigned as the Assignable Pedal function, this message will be transmitted when the controller is used.

- In Combination and Sequencer modes, transmission/reception of this message can be turned on/off independently for each timbre/track (**Enable Foot Pedal/Switch** C/S-MIDI FILTER>3).

Damper pedal (CC#64) [Bn, 40, vv]

This message is transmitted when you use a damper pedal (optional DS-1H) connected to the DAMPER jack, and the damper effect will be turned on/off. If the DS-1H is used, a half-damper effect can be applied.

In Combination and Sequencer modes, transmission/reception of this message can be turned on/off independently for each timbre/track (**Enable Damper** C/S-MIDI FILTER>3).

SW1 modulation (CC#80) [Bn, 50, vv]

SW2 modulation (CC#81) [Bn, 51, vv]

If the above CC# are assigned as the function of SW1 or SW2, using the switch will transmit this message with vv=127 [7F] for ON, and vv=00 [00] for OFF.

- In Combination and Sequencer modes, transmission/reception of these messages can be turned on/off independently for each timbre/track (**Enable SW1, Enable SW2** C/S-MIDI FILTER>3)

Foot switch (CC#82) [Bn, 52, vv]

If the above CC# is assigned as the function of the ASSIGNABLE SWITCH, using the switch will transmit this message with vv=127 [7F] for ON, and vv=00 [00] for OFF.

- In Combination and Sequencer modes, transmission/reception of this message can be turned on/off independently for each timbre/track (“Enable Foot Switch” C/S-MIDI FILTER>3).

Sostenuto (CC#66) [Bn, 42, vv]

If the above CC# is assigned as the function of the ASSIGNABLE SWITCH, using the switch will transmit this message with vv=127 [7F] for ON, and vv=00 [00] for OFF, and the sostenuto effect will be turned on/off. When this message is received, the result will be the same as when the controller is used (OFF for vv=63 [3F] or below, and ON for vv=64 [40] or above).

Soft pedal (CC#67) [Bn, 43, vv]

If the above CC# is assigned as the function of the ASSIGNABLE SWITCH, using the switch will transmit, and the soft pedal effect will be turned on. When this message is received, the result will be the same as when the controller is used.

When “Foot controller (CC#04)”-“Soft pedal (CC#67)” are used on the KROSS, the specified alternate modulation or dynamic modulation etc. will be controlled. When these messages are received, the result will be the same as if the controller had been used. For “SW1 modulation (CC#80)”-“Soft pedal (CC#67),” vv of 63 [3F] or less will be OFF, and 64 [3F] or greater will be ON.

Controlling via the controllers of a connected MIDI instrument such as the KRONOS

Ribbon Controller (CC#16) [Bn, 10, vv]

When a control change is received from the ribbon controller or other assigned controller of a MIDI instrument (such as the KRONOS), the specified effect (e.g., alternate modulation or dynamic modulation) will be applied.

- In Combination or Sequencer modes, transmission and reception can be turned on/off for each timbre/track. (“Enable Ribbon CC#16” on page 82, page 122)

Knob modulation 1–4 (CC#17, 19, 20, 21)
[Bn, 11, vv], [Bn, 13, vv], [Bn, 14, vv], [Bn, 15, vv]

When control changes assigned to the realtime control knobs of a MIDI device such as the KRONOS are received, an effect such as the assigned alternate modulation or dynamic modulation will be applied.

Controller (CC#85, CC#86, CC#87, CC#88)
[Bn, 12, vv], [Bn, 13, vv], [Bn, 14, vv], [Bn, 15, vv]

When the VALUE dial of MIDI instruments such as the KRONOS, or a control change assigned to a controller is received, the specified alternate modulation or dynamic modulation effect will be applied.

Controlling Program tone & envelope shapes

CC#70–79 control specific parameters of a program.

For details on the program parameters that correspond to each control change, and how the KROSS will respond in each mode when these are received, refer to “KROSS and MIDI CCs” on page 295.

- Filter cutoff (CC#74)** [Bn, 4A, vv]
- Resonance level (CC#71)** [Bn, 47, vv]
- Filter EG intensity (CC#79)** [Bn, 4F, vv]
- Release time (CC#72)** [Bn, 48, vv]
- Sustain level (CC#70)** [Bn, 46, vv]
- Attack time (CC#73)** [Bn, 49, vv]
- Decay time (CC#75)** [Bn, 4B, vv]
- LFO 1 speed (CC#76)** [Bn, 4C, vv]
- LFO 1 depth (pitch) (CC#77)** [Bn, 4D, vv]
- LFO 1 delay (CC#78)** [Bn, 4E, vv]

When these messages are received, the result will be the same as when the controller is used. (When the message has a value vv=64 [40], the setting will have the value that was set by the program parameter.)

Note: In Program mode, the corresponding program parameters will be temporarily edited by these messages. You can Write the program to save the modified state (except for certain parameters). The Write operation can also be performed by a MIDI System Exclusive Program Write Request message, in addition to the usual method of using the KROSS’s buttons. When you write the data, the values of the corresponding program parameters will be rewritten.

Note: The results of receiving these messages will depend on the instrument. The operation may be different when a device other than the KROSS is connected.

Arpeggiator control

If you assign a CC# to an arpeggiator parameter and use the KROSS, that CC# will be transmitted and the KROSS will be controlled. When that CC# is received, the same effect will be applied as when the KROSS is used.

To use this, set the G-MIDI> OUT page ARP Controllers MIDI Out setting to Control Change, and use the G-INPUT/CTRL> CC page to specify the parameters.

Control changes can be assigned in the range of CC#000--119, but normally you'll use the following default settings.

ARP ON/OFF (CC#14) [Bn, 0E, vv]

This corresponds to the [ARP] switch. The transmitted value will be vv=127[7F] when on, and vv=0 when off.

ARP GATE (CC#22) [Bn, 16, vv]

ARP VELOCITY (CC#23) [Bn, 17, vv]

ARP SWING (CC#24) [Bn, 18, vv]

These correspond to the ARP parameters.

Silencing all notes on a specific channel

All note off (CC#123) [Bn, 7B, 00] (value 00)

When this is received, all currently-sounding notes on that channel will be turned off (as though the keys had been released). However, the release portion of the notes will remain.

All sound off (CC#120) [Bn, 78, 00] (value 00)

When this is received, all currently-sounding notes on that channel will be silenced. While the All Note Off message allows the release portion of the notes to remain, the All Sound Off message will silence the notes immediately.

However, these messages are provided for emergency use, and are not something that you will use while performing.

Resetting all controllers on a specific channel

Reset all controllers (CC#121) [Bn, 79, 00] (value 00)

When this is received, the value of all controllers on that channel will be reset.

Using RPN (Registered Parameter Numbers)

RPN (Registered Parameter Numbers) are a type of message that allow settings to be made in a way that is common between instrument manufacturers. (NRPN (Non-registered Parameter Numbers) and exclusive messages can be freely used in non-compatible ways by different manufacturers and models of instrument.)

RPN messages can be used for editing with the following procedure.

1. Use **RPN MSB (CC#101)** [Bn, 65, mm] and **RPN LSB (CC#100)** [Bn, 64, rr] (n: channel, mm, rr: upper and lower bytes of the parameter number) messages to select the parameter.
2. Use **data entry MSB (CC#6)** [Bn, 06, mm] and **data entry LSB (CC#38)** [Bn, 26, vv] (n: channel, mm, vv: upper and lower bytes of the value, together expressing 16,384 levels) to specify the value.
3. You can use **data increment (CC#96)** [Bn, 60, 00] or **data decrement (CC#97)** [Bn, 61, 00] (n: channel, value is fixed at 00) to change the value in steps of one.

The KROSS can receive the following three RPN messages (tuning, transpose, and pitch bend range).

Tuning

RPN fine tune [Bn, 65, 00, 64, 01]

This RPN message can be used to adjust the detuning for a program or timbre (in Combination mode), or for a track (in Sequencer mode).

The procedure is as follows.

1. [Bn, 65, 00, 64, 01]: Select RPN parameter 01.
2. [Bn, 06, mm, 26, vv]: Use data entry to set the value. A value of 8192 [mm, vv=40, 00] is center, 0 [mm, vv=00, 00] is -100 cents, and 16383 [mm, vv=7F, 7F] is +99 cents.

Note: You can use the universal exclusive Fine Tune message to adjust the overall tuning that corresponds to the **Master Tune** (GLOBAL> BASIC) parameter. (see “About system exclusive messages” on page 304)

Transposing

RPN coarse tune [Bn, 65, 00, 64, 02]

This RPN message can be used to adjust the transposition for a program or timbre (in Combination mode), or for a track (in Sequencer mode).

The procedure is as follows.

1. [Bn, 65, 00, 64, 02]: Select RPN parameter 02.
2. [Bn, 06, mm, 26, vv]: Use data entry to set the value. Normally only the upper byte is used.

A value of 8192 [mm, vv=40, 00] is center, 6656 [mm, vv=34, 00] is -12 semitones, and 9728 [mm, vv=4C, 00] is +12 semitones.

Note: You can use the universal exclusive Coarse Tune message to adjust the overall tuning that corresponds to the **Key Transpose** (GLOBAL> BASIC) parameter. (see “About system exclusive messages” on page 304)

Changing the pitch bend range

RPN pitch bend range [Bn, 64, 00, 65, 00]

This RPN message can be used to adjust the pitch bend range for a program or timbre (in Combination mode) or for a track (in Sequencer mode).

The procedure is as follows.

1. [Bn, 65, 00, 64, 00]: Select RPN parameter 00.
2. [Bn, 06, mm, 26, vv]: Use data entry to set the value. Normally only the upper byte is used.

A value of 0 [mm, vv=00, 00] is +00, and a value of 1536 [mm, vv=0C, 00] is +12 (one octave). Although it is possible to set a negative value for a timbre/track, only positive values can be set using RPN messages.

About system exclusive messages

Since the way that these messages are used is left up to each manufacturer, they are mainly used to transmit and receive sound data and editing data for parameters that are unique to a particular instrument. The KROSS’s system exclusive message format is [F0, 42, 3n, 00, 01, 15, ff, F7]

- F0:** exclusive status
- 42:** Korg ID
- 3n:** [n=0–F] global MIDI channel 1–16
- mm:** Model ID byte 1 (00)
- mm:** Model ID bytes 2 (01)
- mm:** Model ID bytes 3 (15)
- ff:** function ID (type of message)
- :
- :
- F7:** end of exclusive

Note: To obtain a copy of the “MIDI Implementation” which includes MIDI System Exclusive format information, please contact your Korg distributor.

Universal system exclusive

Certain portions of the system exclusive messages are publicly defined for a specific use, and these are called universal system exclusive messages.

The KROSS uses the following six universal system exclusive messages.

Inquiry message request [F0, 7E, nn, 06, 01, F7]

Inquiry message [F0, 7E, nn, 06, 02, (nine bytes), F7]

When an inquiry message request is received, the KROSS will respond by transmitting an inquiry message that means “I am a Korg KROSS, with system version ...”

GM system on [F0, 7E, nn, 09, 01, F7]

When this message is received in Sequencer mode, the KROSS will be initialized for GM playback.

Master volume [F0, 7F, nn, 04, 01, vv, mm, F7]

(vv: lower byte of the value, mm: upper byte of the value, together indicating 16384 steps)

This message is transmitted if you assign Master Volume as the function of the Assignable Pedal. This will adjust the overall volume balance without changing the relative volume balance between timbres/tracks. When this message is received, the result will be the same as when the controller is used.

Master balance [F0, 7F, nn, 04, 02, vv, mm, F7]

(vv: lower byte of the value, mm: upper byte of the value, together indicating 16384 steps, where 8192 is the default position, and lower values will move the sound toward the left)

When this is received, the overall panning will be adjusted without changing the relative panning between timbres/tracks.

Master fine tuning [F0, 7F, nn, 04, 03, vv, mm, F7]

(A value of 8192 [mm, vv=40, 00] is center, 4096 [mm, vv=20, 00] is -50 cents, and 12288 [mm, vv=60, 00] is +50 cents.)

When this is received, the **Master Tune** (GLOBAL> BASIC) parameter will be set.

Master coarse tuning [F0, 7F, nn, 04, 04, vv, mm, F7]

(Normally only the upper byte mm is used. A value of 8192 [mm, vv=40, 00] is center, 6656 [mm, vv=34, 00] is -12 semitones, and 9728 [mm, vv=4C, 00] is +12 semitones.)

When this is received, the **Key Transpose** (GLOBAL> BASIC) parameter will be set.

Transmitting sound settings data (Data Dump)

Data for programs, combinations, drum kits, user arpeggio pattern, global settings, and sequencer data can be transmitted as MIDI System Exclusive messages. The process of sending this system exclusive data to an external device is called a “data dump.”

By performing a data dump, you can store the KROSS’s sounds and settings on an external device, or rewrite the sounds and settings of another KROSS.

There are the following two types of data dump.

- When you use the **Dump** (G–MIDI) function to dump data, various types of internal memory data will be transmitted. If this data is received by the KROSS, the data will be written directly into internal memory, and it will not be necessary to perform the Write procedure. (see “Sending SysEx data dumps” on page 177 on “Receiving SysEx data dumps” on page 178)
- If the **Enable Exclusive** (G–MIDI> FILTER) setting is checked, data will also be dumped in response to a Dump Request message. This data is transmitted and received on the global MIDI channel.

When the KROSS receives this data, the data will be written into the edit buffer. If you want to save the data into internal memory, you’ll have to execute the Write procedure. This can be done either by executing the Write procedure (see “Writing to internal memory” on page 102 of the Operation Guide) on the KROSS itself, or by a MIDI System Exclusive program write request, combination write request, drum kit write request, user arpeggio pattern write request or global setting write request.

Editing sounds via SysEx

By using various MIDI System Exclusive data dumps, you can rewrite all programs or an individual program. By using parameter change messages, you can edit individual parameters as follows.

Parameter changes

- In Program mode, all parameters other than the program name can be edited.
- In Combination mode, parameters other than the combination name can be edited.
- In Sequencer mode, you can edit the track parameters in SEQ, S-INPUT/CTRL, S-LOOP/TONE, S-TRACK, S-ZONE/DELAY, S-MIDI FILTER, and S-ARP, S-DRUM TRACK, S-STEP SEQ, S-FX ROUTING, S-IFX, S-MFX parameters. (see “System Exclusive events supported in Sequencer mode” on page 152)

Drum kit parameter change and user arpeggio pattern parameter change

In Global/Media mode, you can edit drum kit and user arpeggio patterns.

Since the other global parameters or Sequencer mode musical data cannot be edited, you will use data dumps to transfer this data.

The global MIDI channel is used to transmit and receive this data.

First check the **Enable Exclusive** (G-MIDI> FILTER) setting to enable transmission and reception of exclusive data. When you switch modes on the KROSS, a mode change will be transmitted. When you edit individual parameters, parameter change messages will be transmitted.

When these messages are received, the same editing process will be performed as on the transmitted device.

⚠ Cautions regarding data dumps and sound editing

- After MIDI System Exclusive data has been received and processed, a Data Load Completed message will be transmitted. The control master device must not transmit the next message until this message is received (or until a sufficient interval of time has elapsed).
- When you use parameter changes to edit, the changes will affect the data in the edit buffer and will not be stored in internal memory unless you Write it, so any changes will be lost if you re-select the program or combination. The Write procedure can be performed by a MIDI System Exclusive Program Write Request or Combination Write Request message, in addition to the usual method of using the KROSS’s buttons. For more information, please see “Writing to internal memory” on page 102 of the Operation Guide.
- Songs cannot be written into internal memory. Important data that you want to keep must be saved to an SD card before you turn off the power. For more information, please see “Saving to SD card” on page 102 of the Operation Guide.

If notes are “stuck”

If some problem causes “stuck” notes that continue sounding even though you are no longer playing on the keyboard or via MIDI, you can stop the sound by switching the KROSS’s mode.

Playing the KROSS multi-timbrally from an external device

The KROSS can be connected to an external device and played multi-timbrally in the following ways.

- MIDI messages from the external device can play a combination (16-part multi-timbral performance). You can change the overall settings (programs, levels, and effects) by using program change messages to switch combinations.
- MIDI messages from the external device can be used to play a song (16-part multi-timbral performance). Overall settings (programs, levels, effects etc.) can be changed by using a Song Select message to switch songs.
- MIDI Clock messages from the external device can be used to make the KROSS playback a song (set **MIDI Clock** to External

MIDI, and run the KROSS’s sequencer). (“Synchronizing the playback of the Arpeggiator, Drum Track function or sequencer”) You can change the overall settings (programs, levels, effects) by using song select messages to switch songs.

Note: **MIDI Clock** Ext-USB will function in the same way as Ext-MIDI. With the Auto setting, external MIDI clock data that’s received at the MIDI IN connector or the USB B connector will automatically cause the KROSS to switch to the same method of operation as Ext-MIDI or Ext-USB.

Synchronizing the playback of the Arpeggiator, Drum Track function or sequencer

The choice of whether the KROSS will be the master (the controlling device) or the slave (the controlled device) is made by **MIDI Clock** (G-MIDI> BASIC).

Note: When MIDI Clock is set to Auto, the KROSS will normally function in the same way as for the Internal setting. When an external MIDI clock message is received from the MIDI IN or USB connector, the KROSS will automatically run as it would for the Ext-MIDI setting.

Using the KROSS as master and the external MIDI device as slave

Connect the KROSS’s MIDI OUT connector to the MIDI IN connector of the external MIDI device. Connect the KROSS’s USB B connector to your computer’s USB port.

- When you set **MIDI Clock** to Internal, the KROSS will be the master device, and will transmit MIDI timing clock messages.

Arpeggiator, Drum Track, and Step sequencer function:

The tempo can be controlled from the KROSS. (In Program mode, the performance data of the Drum Track is transmitted if the Drum Track “Prog MIDI Out” (see page 162) setting is selected. The performance data of the step sequencer is transmitted if the Step Seq **Prog MIDI Out** (see page 162) setting is selected).

Performance data from the Arpeggiator, the Drum Track, and the Step sequencer function in Combination or Sequencer mode will be transmitted from the timbres or MIDI tracks where the **Status** is BTH, EXT, or EX2.) An external tone generator connected to the MIDI OUT or USB port will sound, and the tempo of an external sequencer can be controlled.

Sequencer: The musical data can be played back and controlled on the KROSS.

Simultaneously, the sequencer playback will be transmitted via MIDI from the MIDI tracks where the **Status** is BTH, EXT, or EX2. An external tone generator that’s connected to the MIDI OUT or USB port will sound, and the tempo of an external sequencer can be controlled.

Using the external MIDI device as master and the KROSS as slave

Connect the KROSS’s MIDI IN connector to the MIDI OUT connector of the external MIDI device. Connect the KROSS’s USB connector to your computer’s USB port.

- If you use the MIDI connectors for the connections, set the **MIDI Clock** to External MIDI. If you use the USB connector for the connections, set it to External USB. The KROSS will be the slave.

Arpeggiator, Drum Track, and Step sequencer function: The tempo will follow the MIDI timing clock. If you playback the external sequencer, the KROSS’s Arpeggiator or Drum Track function will synchronize to the external timing clock.

Even if **MIDI Clock** is Ext-MIDI or Ext-USB and the KROSS is being controlled from the external device, the performance of the Arpeggiator or Drum Track function will still be trans-

mitted via MIDI. (In Program mode, the performance data of the Drum Track is transmitted if the Drum Track “Prog MIDI Out” (see page 162) setting is selected. The performance data of the step sequencer is transmitted if the Step Seq “Prog MIDI Out” (see page 162) setting is selected.)

Performance data from the Arpeggiator, the Drum Track, and the Step sequencer function in Combination or Sequencer mode will be transmitted from timbres or MIDI tracks where the **Status** is BTH, EXT, or EX2.

Sequencer: The KROSS will not be able to control the performance data; it will be controlled by the external MIDI device that’s connected to the MIDI IN or the computer that’s connected to the USB port. If you wish to playback the external sequencer to make the KROSS’s sequencer playback in synchronization to the external timing clock, you must first set the same time signature and starting measure locations on both devices.

Even if **MIDI Clock** is set to Ext-MIDI or Ext-USB and the KROSS is being controlled from an external device, musical data will be transmitted by tracks where the **Status** is BTH, EXT, or EX2.

Recording musical data from an external device

There are two ways that you can play back an external sequencer and record its playback on the KROSS.

- Set **MIDI Clock** (see page 160) to Internal, begin recording, and then start the external sequencer. With this method, the MIDI messages will be recorded without the two devices being synchronized. Since the incoming musical data will simply be recorded, this method allows the performance to be reproduced faithfully, but since measure divisions etc. will not be kept track of, this method is not suitable if you intend to edit the data later.
- If you set **MIDI Clock** to External MIDI or External USB, the start of recording and the tempo etc. will all be under the control of the external sequencer.

Since the two devices will be synchronized during the recording process, measure divisions etc. will be accurately preserved. (You will need to set the time signature before recording.) For more information, please see “Multi REC” on page 109.

Recording the MIDI output of the KROSS’s controllers, Arpeggiator, Drum Track, Step Sequencer function and internal sequencer to an external sequencer/computer

If you wish to record the MIDI output of the KROSS’s controllers, Arpeggiator, Drum Track, Step sequencer function, and internal sequencer on an external sequencer or computer and use the KROSS as the monitoring and playback tone generator while you record, you must turn off the KROSS’s Local Control setting (**Local Control On G–MIDI> BASIC**), and set your external sequencer/computer for echo-back (a function by which the data received at MIDI IN is retransmitted without change from MIDI OUT) so that the data from the KROSS’s controllers, Arpeggiator, Drum Track, Step sequencer function and internal sequencer will not be applied in duplicate to the tone generator.

Using an external MIDI sequencer/computer to record performance data from the Drum Track function

Turn off the KROSS’s local control setting. In Program mode, the Drum Track function will transmit performance data if the Drum Track **Prog MIDI Out** setting (G–MIDI> OUT) is on (checked). By default, this is off (unchecked), so you’ll need to turn it on.

In your external sequencer/computer, turn the echo-back setting on. With these settings, the sound generator won’t produce duplicate notes, and recording and playback will occur correctly.

Using the modulation wheel to record MIDI control changes on an external MIDI sequencer/computer

Set the KROSS to Local Control Off. Set the external MIDI sequencer/computer to Echo Back On. With these settings, recording and playback will occur correctly, and the control changes will not be applied to the tone generator in duplicate.

Recording the Arpeggiator on an external MIDI sequencer/computer

When the arpeggiator is on, playing the keyboard or using the controllers of the KROSS will run and control the arpeggiator.

In the same way, the arpeggiator will be controlled by MIDI messages received from MIDI IN.

Notes that are transmitted from MIDI OUT (USB) by the arpeggiator are controlled as follows, according to the local control setting (**Local Control On G–MIDI> BASIC**).

Local Control On: Notes from the arpeggiator will be transmitted from MIDI OUT (USB).

Local Control Off: Notes from the arpeggiator will not be transmitted from MIDI OUT (USB). Only notes generated by the arpeggiator in response to MIDI messages received at MIDI IN will be sounded.

Setting example 1

Record the note messages generated by the arpeggiator on the external MIDI sequencer/computer.

1. **Turn on this instrument’s arpeggiator. Set this instrument to Local Control On.**
2. **Turn Local Control On for this instrument.**
3. **Turn Echo Back Off on your external sequencer/computer.**

By turning echo back off, you will prevent the arpeggiator from performing duplicate processing on the monitored notes during recording.

4. **During playback, turn off the arpeggiator of this instrument.**

Setting example 2

Use the external MIDI sequencer/computer to record only the notes that trigger the arpeggiator, and use this instrument’s arpeggiator for monitoring while recording, and during playback.

1. **Turn on the KROSS’s arpeggiator .**
2. **Set the KROSS to Local Control Off.**

The note messages generated by the arpeggiator will not be output.

3. **On your external MIDI sequencer/computer, turn echo back on.**

With these settings, the data will be recorded and played correctly, and the arpeggiator will not be applied in duplicate.

About GM (General MIDI)

The KROSS supports the GM standard. It also supports the GM2 sound map (including bank select) with 256 programs and 9 drum programs provided in ROM banks GM, g(1)–g(9), and g(d). (Banks g(1)–g(9) are GM2 variation programs, and g(d) contains drum programs.)

GM is a standard that ensures basic compatibility of sounds and controllers between GM-compatible instruments made by different manufacturers. When using GM with KROSS, be aware of the following.

- GM System On is supported in Sequencer mode. For more information, please see the “GM Initialize” section on page 141.
- When you wish to play a GM sequence, or load GM data into a song, set **Bank Map** (see page 158) to GM(2).

About standard MIDI files

Standard MIDI files (SMF) make it possible for different computer programs or musical instruments made by different manufacturers to exchange time-based MIDI data. Each standard MIDI file contains one song. The KROSS supports format 0 (type 0) where all of the MIDI data is combined into one track, and format 1 (type 1) where the data is separated by track.

When a SMF is loaded into a song in Global/Media mode, the program bank that is selected will differ depending on the **Bank Map** (see page 158) setting. When playing/loading SMF data that conforms to the GM specifications, set **Bank Map** to GM(2).

Sequencer mode

In Global/Media mode when you convert a song into a Standard MIDI File and save it, you can choose either format 0 or format 1.

- If KROSS song data that was saved as a format 1 SMF file is loaded into another device, the track configuration may be different than it was before being saved. This is because MIDI tracks that contain no musical data are omitted, and the remaining tracks are moved into the unused tracks. This will not affect the playback itself.
- If song data that was saved by another device as a format 1 SMF file is loaded into the KROSS, the track configuration may be different than it was before being saved. This is because tracks that contain no musical data are omitted, and the remaining tracks are moved into the unused tracks. This will not affect the playback itself.

When exchanging sequence data between two KROSS, we recommend that you save the sequence data in the KROSS's native format (**Save SEQ**).

When sequence data is saved in the KROSS's native format, all of the settings and patterns unique to the KROSS will be saved, which will ensure a higher level of reproducibility than when the data is saved as a Standard MIDI File (**Save to Std MIDI File**).

Parameter changes and other recorded data is included in the song data as System Exclusive events, so it can be saved to or loaded from media as usual. Exclusive messages can also be loaded or saved as SMF (Standard MIDI File) data (**Load Standard MIDI File**, **Save Song as Standard MIDI File**). This allows recorded System Exclusive events to be saved as SMF data, or exclusive messages included in SMF data to be converted into song data.

During playback, this data can be transmitted to an external MIDI device, or used to control track parameters or effect parameters of the song.

File compatibility with the microSTATION

The KROSS can convert and load microSTATION format .PCG and .SNG files.

The microSTATION itself cannot load KROSS format .PCG and .SNG files. Song data (.SNG) can be loaded into the microSTATION by saving it as a standard MIDI file (SMF format). (see page 184)

When loading microSTATION format .PCG or .SNG files into the KROSS, please be aware of the following limitations.

Parameters for functions not found on the KROSS

Since the KROSS does not have these functions, the related parameters will not be loaded.

Program

- Audition Riff parameters
- Realtime Controls parameters
- Total Effect parameters

Combination/Song

- Realtime Controls parameters
- Total Effect parameters

Global

- External Setup parameters
- System Preference parameters Scroll Text and Initial Song

Switch/pedal assignment parameters

Settings for functions that are available on the KROSS will be preserved. Settings for functions that aren't available on the KROSS will be Off.

Global

- Foot Switch Assign parameters
- Foot Pedal Assign parameters

Category

The categories on the KROSS will be assigned.

Global

- Program/Combination Category

Multisamples and drum samples

The microSTATION and the KROSS have different internal multisamples and drum samples. When loading, similar multisamples or drum samples will be substituted.

Program

- Oscillators 1/2, multisamples

Global

- Drum kits and drum samples

Bank/number structure of the KROSS and the microSTATION

The bank and number structure for combinations, programs, drum kits, and arpeggiator patterns of the KROSS and the microSTATION are shown below. The following table shows the correspondence when microSTATION format files are loaded into the KROSS.

microSTATION bank structure	KROSS bank structure
Combinations	
A	U (*1)
B	- (*2)
C	- (*2)
Program	
A	U (*1)
B	- (*2)
C	- (*2)
D	- (*2)
G, g(1)..g(9), g(d)	- : G, g(1)..g(9), g(d)
Drum kits	
00(INT)...31(INT)	00(INT)...31(INT)
32(User)...47(User)	32(User)...47(User)
User arpeggio patterns	
000...511(INT)	000...511(INT)
	- : 512...915(INT)
512...623(User)	916...1027(User)
624...639(User)	-

Only one bank each of microSTATION combinations and programs can be loaded into the U bank of the KROSS. It is not possible to load the data of all banks at once.

(*1) When you load a microSTATION format .PCG file, the combination bank A and program bank A will be loaded into the KROSS combination bank U and program bank U respectively.

(*2) By opening a microSTATION format .PCG file and loading an individual bank, banks other than bank A can be loaded into the KROSS bank U.

If you load data for which the KROSS has no corresponding bank or number, the KROSS will run with adjusted settings when the corresponding bank does not exist. For this reason, the resulting sound might not be correct.

MIDI Implementation

KROSS MIDI IMPLEMENTATION

Dec.25.'12

Consult your local Korg dealer for more information on MIDI System Exclusive implementation.

1. TRANSMITTED DATA

1-1 CHANNEL MESSAGES

[H] :Hex, [D] :Decimal

[Status]	Second	Third	Description (Transmitted by)		ENA
[Hex]	[H] [D]	[H] [D]			
8n	kk (kk)	40 (64)	Note Off	(Key Off)	*1 A
9n	kk (kk)	vv (vv)	Note On (vv)=1-127	(Key On)	*1 A
An	kk (kk)	vv (vv)	Poly Key Pressure	(Sequencer data)	Q
Bn	00 (00)	mm (mm)	Bank Select(MSB)	(Prog/Combi change)	*2 PB
Bn	01 (01)	vv (vv)	Modulation1	(Modulation Wheel)	C
Bn	02 (02)	vv (vv)	Modulation2	(Pdl = JS-Y)	C
Bn	04 (04)	vv (vv)	Foot Pedal	(Pdl = Foot Pedal)	C
Bn	05 (05)	vv (vv)	Portamento Time	(Pdl = Porta.Time, S Chg)	C
Bn	07 (07)	vv (vv)	Volume	(Pdl = Volume, S/C Chg)	C
Bn	08 (08)	vv (vv)	Post IFX Panpot	(Pdl = Post IFX Pan, S Chg)	C
Bn	0A (10)	vv (vv)	Panpot	(Pdl = Pan, S Chg)	C
Bn	0B (11)	vv (vv)	Expression	(Pdl = Expression)	C
Bn	0C (12)	vv (vv)	Effect Control 1	(Pdl = FX Control1)	C
Bn	0D (13)	vv (vv)	Effect Control 2	(Pdl = FX Control2)	C
Bn	0E (14)	00/7F (00/7)	ARP ON/OFF, ASW		C
Bn	10 (16)	vv (vv)	Multi Purpose Ctrl1	(ASW/Pdl = CC#16(Rbn))	C
Bn	16 (22)	vv (vv)		(ARP MOD GATE, Pdl)	C
Bn	17 (23)	vv (vv)		(ARP MOD VELOCITY, Pdl)	C
Bn	18 (24)	vv (vv)		(ARP MOD SWING, Pdl)	C
Bn	20 (32)	bb (bb)	Bank Select(LSB)	(Prog/Combi change)	*2 PB
Bn	40 (64)	vv (vv)	Hold1	(Damper, ASW)	C
Bn	41 (65)	00/7F (00/7)	Portamento Off/On	(ASW = Porta.SW, S Chg)	C
Bn	42 (66)	00/7F (00/7)	Sostenuato Off/On	(ASW = Sostenuato)	C
Bn	43 (67)	00/7F (00/7)	Soft Pedal	(ASW = Soft)	C
Bn	50 (80)	vv (vv)	Multi Purpose Ctrl5	(ASW = SW1 Mod.)	C
Bn	51 (81)	vv (vv)	Multi Purpose Ctrl6	(ASW = SW2 Mod.)	C
Bn	52 (82)	vv (vv)	Multi Purpose Ctrl7	(ASW = Foot SW)	C
Bn	5B (91)	vv (vv)	Effect 1 Depth	(Pdl = MFX Send2, S Chg)	C
Bg	5C (92)	00/7F (00/7)	Effect 2 Depth	(All Insert FX Off/On)	C
Bn	5D (93)	vv (vv)	Effect 3 Depth	(Pdl = MFX Send1, S Chg)	C
Bg	5E (94)	00/7F (00/7)	Effect 4 Depth	(Master FX1/2 Off/On)	C
Bn	cc (cc)	vv (vv)	Control (cc)=0-119	(Sequencer data)	Q
Bn	cc (cc)	vv (vv)	Control (cc)=0-119	(ARP Controllers = MIDI CC#00-119)	C
Cn	pp (pp)	--	Program Change	(Prog/Combi change)	*2 P
Dn	vv (vv)	--	Channel Pressure	(Sequence data)	Q
En	bb (bb)	bb (bb)	Bender Change	(Pitch Bend Wheel)	C

Pdl : Assignable Pedal
ASW : Assignable Switch

S Chg : Transmitted when change a Song No.(Seq. mode). (Status = EXT,EX2,BTH)
C/S Chg : Transmitted when change a Combination or Song No.(Seq. mode). (Status = EXT,EX2 or BTH)

n : MIDI Channel No. (0 - 15) -----Usually Global Channel.
When in Combination/Sequencer mode, each timbre's/track's channel. (Status = EXT,EX2 or BTH)
g : Always Global Channel No. (0 - 15)
ENA = A : Always Enabled.

C : Enabled when Enable Control Change in Global mode is on.
P : Enabled when Enable Program Change in Global mode is on.
PB: Enabled when Enable Program and Bank Change in Global mode is on.
T : Enabled when Enable After Touch in Global mode is on.
Q : Enabled when Sequencer is playing(transmit), recording(receive)

*1 : kk = 24 - 108 : KROSS 61 (61keys + Transpose)
= 09 - 120 : KROSS 88 (88keys + Transpose)
= 00 - 127 : Sequencer and ARP

*2 : Program Combination MIDI Out[Hex] (Bank Map is KORG) (Bank Map is GM(2))
Bank A 000 - 127 : Bank A 000 - 127 : mm,bb,pp = 00,00, 00 - 7F = 3F,00, 00 - 7F
B 000 - 127 : B 000 - 127 : 00,01, 00 - 7F = 3F,01, 00 - 7F
C 000 - 127 : U 000 - 127 : 00,02, 00 - 7F = 3F,02, 00 - 7F
D 000 - 127 : 00,03, 00 - 7F = 3F,03, 00 - 7F
U 000 - 127 : 00,04, 00 - 7F = 3F,04, 00 - 7F
GM 001 - 128 : 79,00, 00 - 7F = 79,00, 00 - 7F
g(1)-(9) 001 - 128 : 79,01-09, 00 - 7F = 79,01-09, 00 - 7F
g(d) 001 - 128 : 78,00, 00 - 7F = 78,00, 00 - 7F

1-2 SYSTEM COMMON MESSAGES [H] :Hex, [D] :Decimal

Status	Second	Third	Description (Transmitted when)
[Hex]	[H] [D]	[H] [D]	
F2	ss (ss)	tt (tt)	Song Position Pointer
			ss : Least significant [LSB] *4
			tt : Most significant [MSB] *4
F3	ss (ss)		Song Select (Song is selected)
			ss : Song(0-127)

Transmits Song Position Pointer message when in Sequencer mode. (Internal Clock)
 Transmits Song Select message when in Sequencer mode.

*4 : For example, if time signature is 4/4 or 8/8, tt,ss = 00,10 means one measure.

1-3 SYSTEM REALTIME MESSAGES

Status[Hex]	Description (Transmitted when ...)
F8	Timing Clock (Always in Prog/Combi/Seq/Global mode) *5
FA	Start (START in Seq mode) *5
FB	Continue (Continue START in Seq mode) *5
FC	Stop (STOP in Seq mode) *5
FE	Active Sensing (Always) *6

*5 Transmits these messages when MIDI Clock in Global mode is Internal.

*6 Transmits these messages when MIDI Clock in Global mode is External(except USB-MIDI).

1-4 SYSTEM EXCLUSIVE

1-4-1 UNIVERSAL SYSTEM EXCLUSIVE MESSAGE (NON REALTIME)

DEVICE INQUIRY REPLY (Transmits when received a INQUIRY MESSAGE REQUEST)
 [F0,7E,0g,06,02,42,16,01,mm,00,vv,ww,xx,00,F7]

3rd byte	g : Global Channel
6th byte	42 : KORG ID
7th byte	16 : KROSS series LSB ID
8th byte	01 : KROSS series MSB ID
9th byte	mm : KROSS 61 member code mm = 05 KROSS 88 member code mm = 17
11th byte	vv : System Version 1st (1 -)
12th byte	ww : System Version 2nd (0 -)
13th byte	xx : System Version 3rd (0 -)

(i.e. Version 1.0.2: vv=01, ww=00, xx=02)

1-4-2 UNIVERSAL SYSTEM EXCLUSIVE MESSAGES (REALTIME)

Master Volume
 [F0,7F,0g,04,01,vv,mm,F7]

3rd byte	g : Global Channel
6th byte	vv : Value(LSB)
7th byte	mm : Value(MSB)

mm,vv = 00,00 - 7F,7F : Min - Max

2. RECOGNIZED RECEIVE DATA

2-1 CHANNEL MESSAGES [H] :Hex, [D] :Decimal

Status	Second	Third	Description (Use)		ENA
[Hex]	[H] [D]	[H] [D]			
8n	kk (kk)	xx (xx)		Note Off	A
9n	kk (kk)	00 (00)		Note Off	A
9n	kk (kk)	vv (vv)		Note On (vv) = 1-127	A
An	kk (kk)	vv (vv)		Poly Key Pressure (as AMS)	T,Q
Bn	00 (00)	mm (mm)		Bank Select(MSB) (for Prog/Combi change)	*1 P
Bn	01 (01)	vv (vv)		Modulation1 (as Modulation Wheel)	C
Bn	02 (02)	vv (vv)		Modulation2 (as Pdl = JS-Y)	C
Bn	04 (04)	vv (vv)		Foot Pedal (as AMS & FX Dmod Src = Foot Pedal)	C
Bn	05 (05)	vv (vv)		Portamento Time	C
Bn	06 (06)	vv (vv)		Data Entry (MSB) (for RPC edit)	C
Bn	07 (07)	vv (vv)		Volume	C
Bn	08 (08)	vv (vv)		Balance Control (for Post IFX Panpot control)	*2 C
Bn	0A (10)	vv (vv)		Panpot	C
Bn	0B (11)	vv (vv)		Expression	C
Bn	0C (12)	vv (vv)		Effect Control 1 (as FX Dmod Src = FXCtrl1)	C
Bn	0D (13)	vv (vv)		Effect Control 2 (as FX Dmod Src = FXCtrl2)	C
Bn	0E (14)	vv (vv)		(as ARP ON/OFF)	*4 C
Bn	10 (16)	vv (vv)		Multi Purpose Ctrl1 (as AMS & FX Dmod Src = Ribbon)	C
Bn	11 (17)	vv (vv)		Multi Purpose Ctrl2 (as AMS & FX Dmod Src = Knob Mod1)	C
Bn	12 (18)	vv (vv)		Multi Purpose Ctrl3 (as AMS & FX Dmod Src = ValueSlider)	C
Bn	13 (19)	vv (vv)		Multi Purpose Ctrl4 (as AMS & FX Dmod Src = Knob Mod2)	C
Bn	14 (20)	vv (vv)		(as AMS & FX Dmod Src = Knob Mod3)	C
Bn	15 (21)	vv (vv)		(as AMS & FX Dmod Src = Knob Mod4)	C
Bn	16 (22)	vv (vv)		(as ARP MOD GATE)	*4 C
Bn	17 (23)	vv (vv)		(as ARP MOD VELOCITY)	*4 C
Bn	18 (24)	vv (vv)		(as ARP MOD SWING)	*4 C
Bn	20 (32)	bb (bb)		Bank Select(LSB) (for Prog / Combi change)	*1 P
Bn	26 (38)	vv (vv)		Data Entry (LSB) (for RPC edit)	C
Bn	40 (64)	vv (vv)		Hold1 (as Damper)	C
Bn	41 (65)	<=3F/>=40 (<=63/>=64)		Portamento Off/On	C
Bn	42 (66)	<=3F/>=40 (<=63/>=64)		Sostenuto Off/On	C
Bn	43 (67)	vv (vv)		Soft Pedal	C
Bn	46 (70)	vv (vv)		Sound Controller 1 (for Sustain Level control)	C
Bn	47 (71)	vv (vv)		Sound Controller 2 (for Resonance control)	C
Bn	48 (72)	vv (vv)		Sound Controller 3 (for Release Time control)	C
Bn	49 (73)	vv (vv)		Sound Controller 4 (for Attack Time control)	C
Bn	4A (74)	vv (vv)		Sound Controller 5 (for Filter Cutoff control)	C
Bn	4B (75)	vv (vv)		Sound Controller 6 (for Decay Time control)	C
Bn	4C (76)	vv (vv)		Sound Controller 7 (for LFO1 Speed control)	C
Bn	4D (77)	vv (vv)		Sound Controller 8 (for LFO1 Pitch Depth control)	C
Bn	4E (78)	vv (vv)		Sound Controller 9 (for LFO1 Delay control)	C
Bn	4F (79)	vv (vv)		Sound Controller 10 (for Filter EG Intensity control)	C
Bn	50 (80)	vv (vv)		Multi Purpose Ctrl5 (as AMS & FX Dmod Src = SW 1)	C
Bn	51 (81)	vv (vv)		Multi Purpose Ctrl6 (as AMS & FX Dmod Src = SW 2)	C
Bn	52 (82)	vv (vv)		Multi Purpose Ctrl7 (as AMS & FX Dmod Src = FootSW)	C
Bn	53 (83)	vv (vv)		Multi Purpose Ctrl8 (as AMS & FX Dmod Src = MIDI CC#83)	C
Bn	55 (85)	vv (vv)		(as AMS & FX Dmod Src = MIDI CC#85)	C
Bn	56 (86)	vv (vv)		(as AMS & FX Dmod Src = MIDI CC#86)	C
Bn	57 (87)	vv (vv)		(as AMS & FX Dmod Src = MIDI CC#87)	C
Bn	58 (88)	vv (vv)		(as AMS & FX Dmod Src = MIDI CC#88)	C
Bn	5B (91)	vv (vv)		Effect 1 Depth (for Send 2 Level control)	C
Bg	5C (92)	00/!=00 (00/!=000)		Effect 2 Depth (for All Insert FX Off/On)	C
Bn	5D (93)	vv (vv)		Effect 3 Depth (for Send 1 Level control)	C
Bg	5E (94)	00/!=00 (00/!=000)		Effect 4 Depth (for Master FX1,2 Off/On)	C
Bn	60 (96)	00 (00)		Data Increment (for RPC edit)	C
Bn	61 (97)	00 (00)		Data Decrement (for RPC edit)	C
Bn	64 (100)	0r (0r)		RPN Param No. (LSB) (for RPN select)	*3 C
Bn	65 (101)	00 (00)		RPN Param No. (MSB) (for RPN select)	*3 C
Bn	cc (cc)	vv (vv)		Control data (for Seq. recording (cc) = 0-119)	C,Q
Bn	78 (120)	00 (00)		All Sound Off	C
Bn	79 (121)	00 (00)		Reset All Controllers	C
Bn	7A (122)	00/7 (00/127)		Local Control Off/On	A
Bn	7B (123)	00 (00)		All Notes Off	A
Bn	7C (124)	00 (00)		Omni Mode Off (as All Notes Off)	A
Bn	7D (125)	00 (00)		Omni Mode On (as All Notes Off)	A
Bn	7E (126)	<=10 (<=16)		Mono Mode On (as All Notes Off)	A
Bn	7F (127)	00 (00)		Poly mode On (as All Notes Off)	A
Cn	pp (pp)	-- --		Program Change (for Prog/Combi change)	*1 P
Dn	vv (vv)	-- --		Channel Pressure (as AMS & FX Dmod Src = After Touch)	T
En	bb (bb)	bb (bb)		Bender Change	C

AMS : Alternate Modulation Source
 FX Dmod Src : Effect Dynamic Modulation Source

n : MIDI Channel No. (0 - 15) ----- Usually Global Channel.
 When in Combination/Sequencer mode, each timbre's/track's channel.(Status is INT or BTH)

g : Always Global Channel No. (0 - 15)
 x : Random
 ENA : Same as Transmitted data

*1 : When Bank Map in Global mode is KORGM;

MIDI In	[Hex]		Program		Combination
mm,bb,pp =	00,00,	00 - 7F	: Bank	A 000 - 127	: Bank A 000 - 127
	00,01,	00 - 7F	:	B 000 - 127	: B 000 - 127
	00,02,	00 - 7F	:	C 000 - 127	: U 000 - 127
	00,03,	00 - 7F	:	D 000 - 127	
	00,04,	00 - 7F	:	U 000 - 127	
	79,00,	00 - 7F	:	G 001 - 128	
	79,01-09,	00 - 7F	:	g(1)-g(9) 001 - 128	
	78,00,	00 - 7F	:	g(d) 001 - 128	
	38,00,	00 - 7F	:	G 001 - 128	
	3E,00,	00 - 7F	:	g(d) 001 - 128	

When Bank Map in Global mode is GM(2);

MIDI In	[Hex]		Program		Combination
mm,bb,pp =	3F,00,	00 - 7F	: Bank	A 000 - 127	: Bank A 000 - 127
	3F,01,	00 - 7F	:	B 000 - 127	: B 000 - 127
	3F,02,	00 - 7F	:	C 000 - 127	: U 000 - 127
	3F,03,	00 - 7F	:	D 000 - 127	
	3F,04,	00 - 7F	:	U 000 - 127	
	79,00,	00 - 7F	:	G 001 - 128	
	79,01-09,	00 - 7F	:	g(1)-g(9) 001 - 128	
	78,00,	00 - 7F	:	g(d) 001 - 128	
	00,00,	00 - 7F	:	G 001 - 128	
	38,00,	00 - 7F	:	G 001 - 128	
	3E,00,	00 - 7F	:	g(d) 001 - 128	
	3F,7F,	00 - 7F	:	Mute (KORG MUTE)	

*2 : When in Program, Global channel.
 When in Combination/Sequencer mode, each IFX's channel.

*3 : r = 0 : Pitch Bend Sensitivity (Bend Range)
 = 1 : Fine Tune (Detune)
 = 2 : Coarse Tune (Transpose)

For drum program, both of Fine Tune and Coarse Tune affect to Detune.
 Data Entry LSB value has no effect for Pitch Bend Sensitivity and Coarse Tune.

*4 : When CC# is assigned to the ARP Controllers in Global Mode.

n : When in Program/Combination mode, Global channel.
 When in Sequencer mode, current selected track's channel.

