

ProFX8 and ProFX12

Professional Mic/Line Mixers with FX and USB I/O

OWNER'S MANUAL

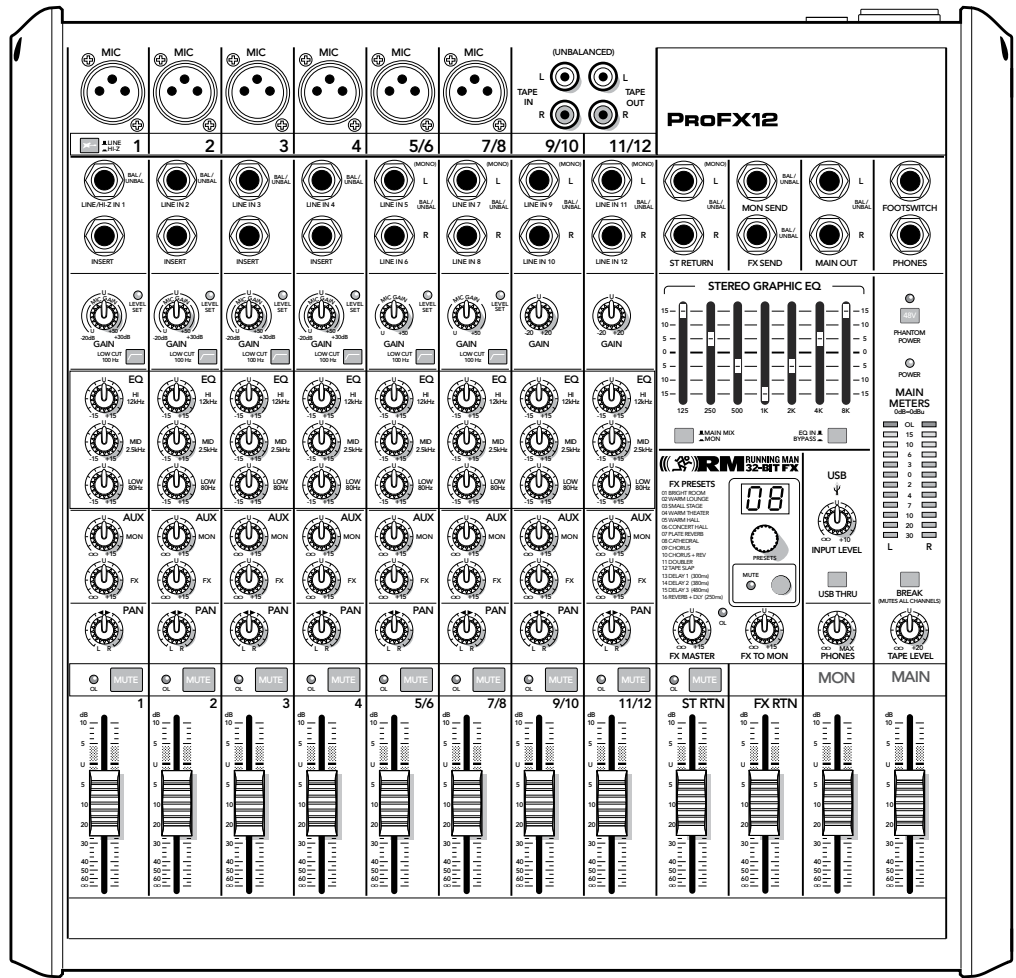
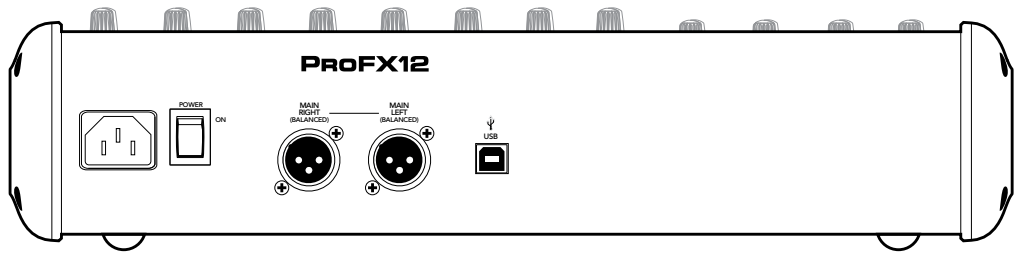

Important Safety Instructions

1. Read these instructions.
2. Keep these instructions.
3. Heed all warnings.
4. Follow all instructions.
5. Do not use this apparatus near water.
6. Clean only with a dry cloth.
7. Do not block any ventilation openings. Install in accordance with the manufacturer's instructions.
8. Do not install near any heat sources such as radiators, heat registers, stoves, or other apparatus (including amplifiers) that produce heat.
9. Do not defeat the safety purpose of the polarized or grounding-type plug. A polarized plug has two blades with one wider than the other. A grounding-type plug has two blades and a third grounding prong. The wide blade or the third prong are provided for your safety. If the provided plug does not fit into your outlet, consult an electrician for replacement of the obsolete outlet.
10. Protect the power cord from being walked on or pinched particularly at plugs, convenience receptacles, and the point where they exit from the apparatus.
11. Only use attachments/accessories specified by the manufacturer.
12. Use only with a cart, stand, tripod, bracket, or table specified by the manufacturer, or sold with the apparatus. When a cart is used, use caution when moving the cart/apparatus combination to avoid injury from tip-over.
13. Unplug this apparatus during lightning storms or when unused for long periods of time.
14. Refer all servicing to qualified service personnel. Servicing is required when the apparatus has been damaged in any way, such as power-supply cord or plug is damaged, liquid has been spilled or objects have fallen into the apparatus, the apparatus has been exposed to rain or moisture, does not operate normally, or has been dropped.
15. This apparatus shall not be exposed to dripping or splashing, and no object filled with liquids, such as vases or beer glasses, shall be placed on the apparatus.
16. Do not overload wall outlets and extension cords as this can result in a risk of fire or electric shock.
17. This apparatus has been designed with Class-I construction and must be connected to a mains socket outlet with a protective earthing connection (the third grounding prong).
18. This apparatus has been equipped with a rocker-style AC mains power switch. This switch is located on the rear panel and should remain readily accessible to the user.
19. The MAINS plug or an appliance coupler is used as the disconnect device, so the disconnect device shall remain readily operable.



20. NOTE: This equipment has been tested and found to comply with the limits for a Class B digital device, pursuant to part 15 of the FCC Rules. These limits are designed to provide reasonable protection against harmful interference in a residential installation. This equipment generates, uses, and can radiate radio frequency energy and, if not installed and used in accordance with the instructions, may cause harmful interference to radio communications. However, there is no guarantee that interference will not occur in a particular installation. If this equipment does cause harmful interference to radio or television reception, which can be determined by turning the equipment off and on, the user is encouraged to try to correct the interference by one or more of the following measures:

- Reorient or relocate the receiving antenna.
- Increase the separation between the equipment and the receiver.
- Connect the equipment into an outlet on a circuit different from that to which the receiver is connected.
- Consult the dealer or an experienced radio/TV technician for help.

CAUTION: Changes or modifications to this device not expressly approved by LOUD Technologies Inc. could void the user's authority to operate the equipment under FCC rules.

21. This apparatus does not exceed the Class A/Class B (whichever is applicable) limits for radio noise emissions from digital apparatus as set out in the radio interference regulations of the Canadian Department of Communications.

ATTENTION — *Le présent appareil numérique n'émet pas de bruits radioélectriques dépassant les limites applicables aux appareils numériques de class A/de class B (selon le cas) prescrites dans le règlement sur le brouillage radioélectrique édicté par les ministere des communications du Canada.*

22. Exposure to extremely high noise levels may cause permanent hearing loss. Individuals vary considerably in susceptibility to noise-induced hearing loss, but nearly everyone will lose some hearing if exposed to sufficiently intense noise for a period of time. The U.S. Government's Occupational Safety and Health Administration (OSHA) has specified the permissible noise level exposures shown in the following chart. According to OSHA, any exposure in excess of these permissible limits could result in some hearing loss. To ensure against potentially dangerous exposure to high sound pressure levels, it is recommended that all persons exposed to equipment capable of producing high sound pressure levels use hearing protectors while the equipment is in operation. Ear plugs or protectors in the ear canals or over the ears must be worn when operating the equipment in order to prevent permanent hearing loss if exposure is in excess of the limits set forth here:

CAUTION AVIS

RISK OF ELECTRIC SHOCK. DO NOT OPEN
RISQUE DE CHOC ELECTRIQUE. NE PAS OUVRIR

CAUTION: TO REDUCE THE RISK OF ELECTRIC SHOCK DO NOT REMOVE COVER (OR BACK) NO USER-SERVICEABLE PARTS INSIDE. REFER SERVICING TO QUALIFIED PERSONNEL.
ATTENTION: POUR EVITER LES RISQUES DE CHOC ELECTRIQUE, NE PAS ENLEVER LE COUVERCLE. AUCUN ENTRETIEN DE PIECES INTERIEURES PAR L'USAGER. CONFIER L'ENTRETIEN AU PERSONNEL QUALIFIE.
AVIS: POUR EVITER LES RISQUES D'INCENDIE OU D'ELECTROCUTION, N'EXPOSEZ PAS CET ARTICLE A LA PLUIE OU A L'HUMIDITE.

The lightning flash with arrowhead symbol within an equilateral triangle is intended to alert the user to the presence of uninsulated "dangerous voltage" within the product's enclosure, that may be of sufficient magnitude to constitute a risk of electric shock to persons.
Le symbole éclair avec point de flèche à l'intérieur d'un triangle équilatéral est utilisé pour alerter l'utilisateur de la présence à l'intérieur du coffret de "voltage dangereux" non isolé d'ampleur suffisante pour constituer un risque d'électrocution.

The exclamation point within an equilateral triangle is intended to alert the user of the presence of important operating and maintenance (servicing) instructions in the literature accompanying the appliance.
Le point d'exclamation à l'intérieur d'un triangle équilatéral est employé pour alerter les utilisateurs de la présence d'instructions importantes pour le fonctionnement et l'entretien (service) dans le livret d'instruction accompagnant l'appareil.

Duration, per day in hours	Sound Level dBA, Slow Response	Typical Example
8	90	Duo in small club
6	92	
4	95	Subway Train
3	97	
2	100	Very loud classical music
1.5	102	
1	105	Matt screaming at Troy about deadlines
0.5	110	
0.25 or less	115	Loudest parts at a rock concert

WARNING — To reduce the risk of fire or electric shock, do not expose this apparatus to rain or moisture.

Read This Page!

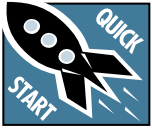

You probably want to try out your new mixer right away. Before you do, please read the safety instructions on page 2, then read this page, and the rest later.

Zero the Mixer

1. Turn down all knobs except the channel EQ and pan knobs, and set all the faders fully down.
2. Set all channel EQ knobs, pan knobs, and the graphic EQ sliders at their center detent.
3. Set all buttons to the “out” position.
4. Whistle a popular show tune.

Connections

If you already know how you want to connect the mixer, go ahead and connect the inputs and outputs the way you want them. If you just want to get sound through the mixer, follow these steps:

1. Plug signal sources into the mixer, such as:
 - Microphones plugged into the mic inputs. Engage phantom power if the mics need it. Check the mic's user manual to be sure.
 - Line-level sources such as keyboards, drum machines, or CD players plugged into the line-level inputs.
 - A guitar plugged into channel 1, with the line/hi-z switch pressed in.
2. Connect cords from the main outs to powered speakers or an amplifier.
3. Plug in the mixer's power cord to a live AC outlet and turn on the mixer.
4. If using powered speakers, turn them on. Otherwise, connect passive speakers to an amp with speaker cables, and turn it on. Adjust the powered speaker or amplifier level controls to however the manufacturer recommends. (This is usually all the way up.)

Set the Gain

1. Play something into an input. This could be an instrument, singing or speaking, or a line level source such as a keyboard or CD player. Be sure that the volume of the input is the same as it would be during normal use, or the gain may have to be readjusted in the middle of a set. You can listen with headphones by carefully turning up the channel fader and headphones level a little.

2. For mono channels, adjust the gain control so the level set LED just comes on occasionally during the loudest parts of the performance. The mono channel gain affects the mic and the line inputs. The hybrid channel gain affects the mic input only, not the stereo line inputs. The stereo channel gain adjusts the stereo line inputs. Adjust as desired, and make sure that the OL LED does not come on during the loudest passages.
3. Repeat steps 1 and 2 for the other channels.

Instant Mixing

1. To get sound out of the speakers and into a waiting world, turn up the channel's fader to the “U” (unity gain) position, and slowly bring up the main fader to a comfortable listening level.
2. Sing and play. You're a star! Bring in the other channels, and adjust their faders to make a nice mix and generally have fun.

USB

The USB connection allows you to play 2 channels of audio from the computer, and to record the main mix to the computer.

Notes

For optimum sonic performance, the channel faders and main fader should be set near the “U” (unity gain) markings.

Turn down all faders before making connections to and from the ProFX mixer.

When shutting down the system, turn off amplifiers or powered speakers first. When powering up, turn them on last. This will prevent the possibility of turn-on and turn-off thumps heard in speakers.

Save the shipping box! You may need it someday.

Please write the serial number here for future reference (i.e., insurance claims, tech support, return authorization, make dad proud, etc.)

Purchased at:

Date of purchase:

Introduction

Thank you for choosing a Mackie professional ProFX mixer. It is equipped with our rather lovely microphone preamps, an internal FX processor and a USB port for playing and recording 2 channels of audio using a computer. The ProFX8 has 8 channels and the ProFX12 has 12 channels. Apart from this difference, the mixers are identical and this manual covers both models.

At Mackie, we know what it takes to be roadworthy. After all, our mixers have traveled all over the world, often under the worst of conditions, and we've applied what we've learned to the mechanical design of our ProFX mixers.

Reliability is paramount to sound reinforcement. That's why our engineers have subjected our mixers to the most rigorous and fiendish tests imaginable to fine-tune the design, and extend its limits beyond those of ordinary mixers.

Features

- The ProFX8 mixer has 8 channels (2 mono, 2 hybrid, 1 stereo)
- The ProFX12 mixer has 12 channels (4 mono, 2 hybrid, 2 stereo)
- Mono channels have a mic input and a mono line-level input, with a gain control and level set LED for adjustment of mic and line gain
- Hybrid channels have a mic input and stereo line-level inputs, with a gain control and level set LED for adjustment of mic gain
- Stereo channels have stereo line-level inputs, with a gain control to adjust the line gain
- +48V phantom power can be applied to all mics
- Tape/CD stereo RCA inputs and outputs
- 1/4" TRS insert jacks on mono channels
- Channel 1 hi-z switch allows direct connection of a guitar or bass without a DI box
- Low cut switch on mono and hybrid channels
- 3-band EQ on each channel
- Aux monitor control on each channel
- Aux FX control on each channel
- Each channel has a pan control, mute switch, overload (OL) LED, and fader
- Stereo return has mute, OL LED and fader
- XLR and 1/4" TRS main stereo line outputs
- 1/4" TRS stereo return
- 1/4" TRS FX send and monitor send
- 1/4" TRS stereo headphones output
- Headphones level control
- Tape input level control
- 16 built-in Running Man effects with input level, OL LED, preset display, FX to monitor level, and footswitchable mute/un-mute
- 7-band graphic EQ can be used for main mix, monitor mix, or bypassed
- 12-segment stereo output meters on main mix
- Break switch mutes all channels except tape input and USB input
- Faders for stereo return, FX return, monitor and main
- USB connection allows 2-channel computer recording and 2-channel computer playback
- USB thru switch and input level

How To Use This Manual

The first few pages after the table of contents are the hookup diagrams. These show typical setups for fun times with your ProFX8 or ProFX12 mixer.

Next is a detailed tour of the entire mixer. The descriptions are divided into sections, just as the mixer is organized into distinct zones:

- Rear Panel: The AC input, power switch, XLR line-level outputs and USB I/O
- Connection Section: The upper section, where you connect microphones, guitars, etc.
- Channel Controls: The channel strips where you adjust and control each channel
- Master Controls: The section on the right, with graphic EQ and main level controls
- Stereo Effect Processor

Throughout these sections are illustrations with each feature numbered and described in the nearby paragraphs.



This icon marks information that is critically important or unique to the mixer. For your own good, read them and remember them.



This icon will lead to some explanations of features and practical tips. Go ahead and skip these if you really need to go.

Appendix A: Service information

Appendix B: Connectors

Appendix C: Technical information

Contents

IMPORTANT SAFETY INSTRUCTIONS	2	26. AUX FX	20
READ THIS PAGE!.....	3	27. PAN.....	20
INTRODUCTION	4	28. OL LED.....	20
CONTENTS	5	29. MUTE	20
HOOKUP DIAGRAMS.....	6	30. CHANNEL FADER	20
REAR PANEL FEATURES	12	MASTER CONTROLS	21
1. POWER CONNECTION.....	12	31. PHANTOM POWER SWITCH.....	21
2. POWER SWITCH.....	12	32. POWER LED	21
3. XLR MAIN OUTS	12	33. METERS	21
4. USB PORT	12	34. BREAK SWITCH	22
FRONT PANEL FEATURES	13	35. TAPE LEVEL	22
CONNECTION SECTION	13	36. STEREO GRAPHIC EQ.....	22
5. MIC INPUTS.....	13	37. MAIN MIX/MON	22
6. LINE/HI-Z SWITCH.....	13	38. EQ IN/BYPASS.....	22
7. LINE/HI-Z INPUT (CHANNEL 1 ONLY).....	13	39. USB INPUT LEVEL	22
8. MONO LINE INPUTS	14	40. USB THRU.....	23
9. STEREO LINE INPUTS	14	41. PHONES LEVEL	23
10. CHANNEL INSERT	14	42. OL LED (FOR STEREO RETURNS).....	23
11. STEREO RETURN	14	43. MUTE (FOR STEREO RETURNS).....	23
12. MON SEND	15	44. STEREO RETURN FADER	23
13. FX SEND	15	45. FX RETURN FADER	23
14. 1/4" MAIN OUTS	15	46. MONITOR FADER	23
15. FX FOOTSWITCH	15	47. MAIN FADER.....	23
16. PHONES	15	STEREO EFFECTS PROCESSOR	24
17. TAPE INPUT	16	48. PRESET DISPLAY	24
18. TAPE OUTPUTS	16	49. PRESET SELECTOR	24
CHANNEL CONTROLS	17	50. INTERNAL FX MUTE.....	24
19. GAIN	18	51. FX MASTER.....	24
20. LEVEL SET LED.....	18	52. OL LED.....	24
21. LOW CUT.....	18	53. FX TO MON	24
22. HI EQ.....	19	APPENDIX A: SERVICE INFORMATION.....	26
23. MID EQ.....	19	APPENDIX B: CONNECTIONS.....	27
24. LOW EQ.....	19	APPENDIX C: TECHNICAL INFORMATION	29
25. AUX MON.....	19	PROFX8 AND PROFX12 LIMITED WARRANTY	32

Need help with your mixer?

- Visit www.mackie.com and click Support to find: FAQs (Frequently Asked Questions), manuals, addendums, and user forums.
- Email us at: techmail@mackie.com.
- Telephone 1-800-898-3211 to speak with one of our splendid technical support representatives, (Monday through Friday, normal business hours, Pacific Time).

HOOKUP DIAGRAMS

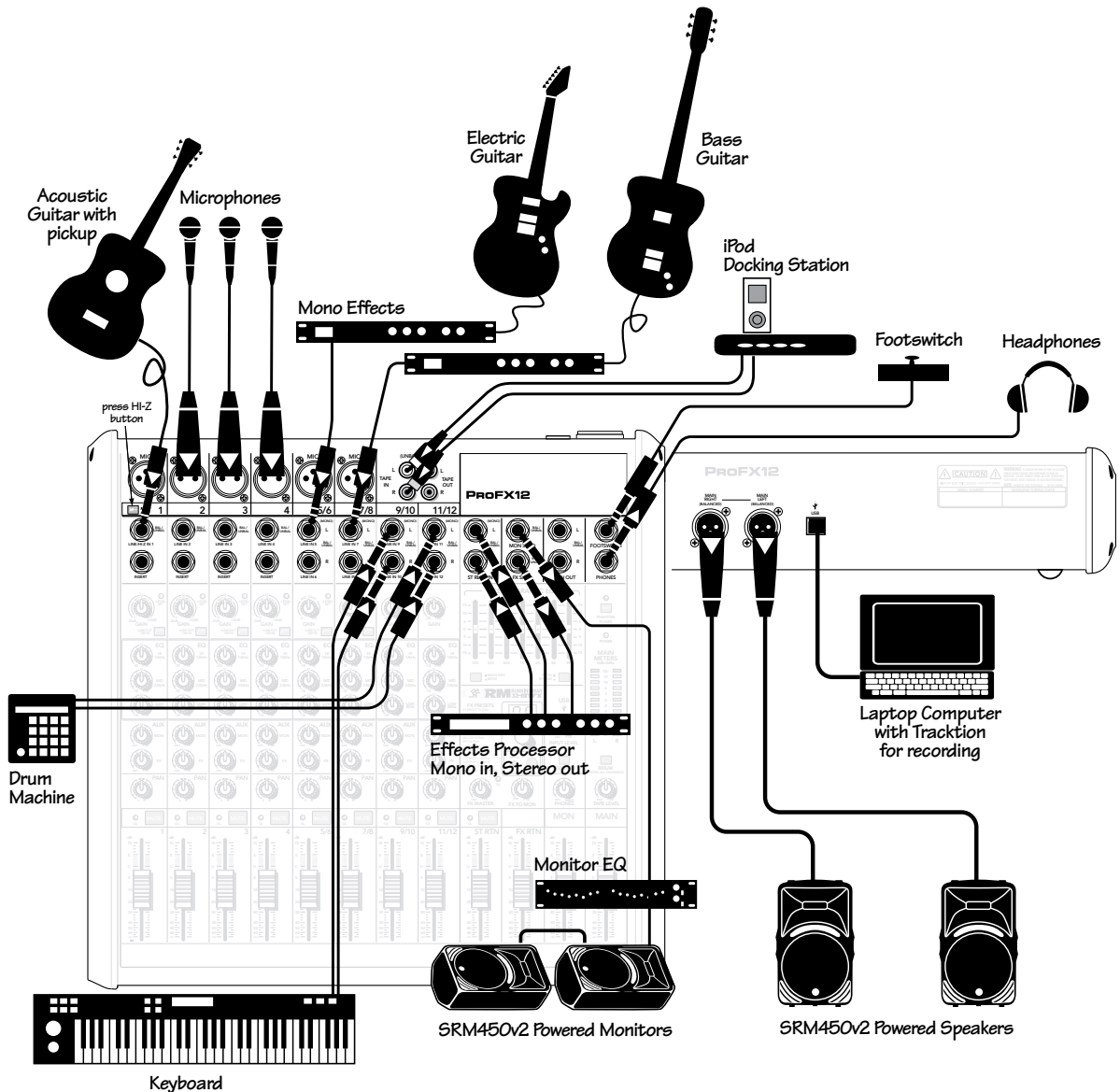

This diagram shows a guitar connected directly to channel 1 (with the hi-z switch pressed in), microphones attached to channels 2, 3, and 4, guitar effects processors connected to the left line-level input of channel 5/6 and 7/8, a keyboard attached to channel 9/10's line-level inputs and a drum machine connected to channel 11/12. An iPod docking station is attached to the stereo tape inputs. An effects processor receives a mono input from the FX send and its stereo outputs connect to the stereo return inputs.

Mackie SRM450v2 powered speakers are connected to the left and right main output. Two of these speakers are also set up as stage monitors and connect to the mixer's monitor output via a graphic EQ. The aux mon controls of each channel allow you to create a stage monitor mix that is independent of the main mix. Use the external graphic EQ to adjust the stage monitor EQ as desired. Headphones are used for monitoring, and a footswitch allows you to mute/un-mute the internal effects as desired.

A laptop connects to the USB port, and allows the 2-channel main mix of the performance to be recorded using Traktion software. Two channels of audio can also play from the computer to the main mix.

Band System ProFX12

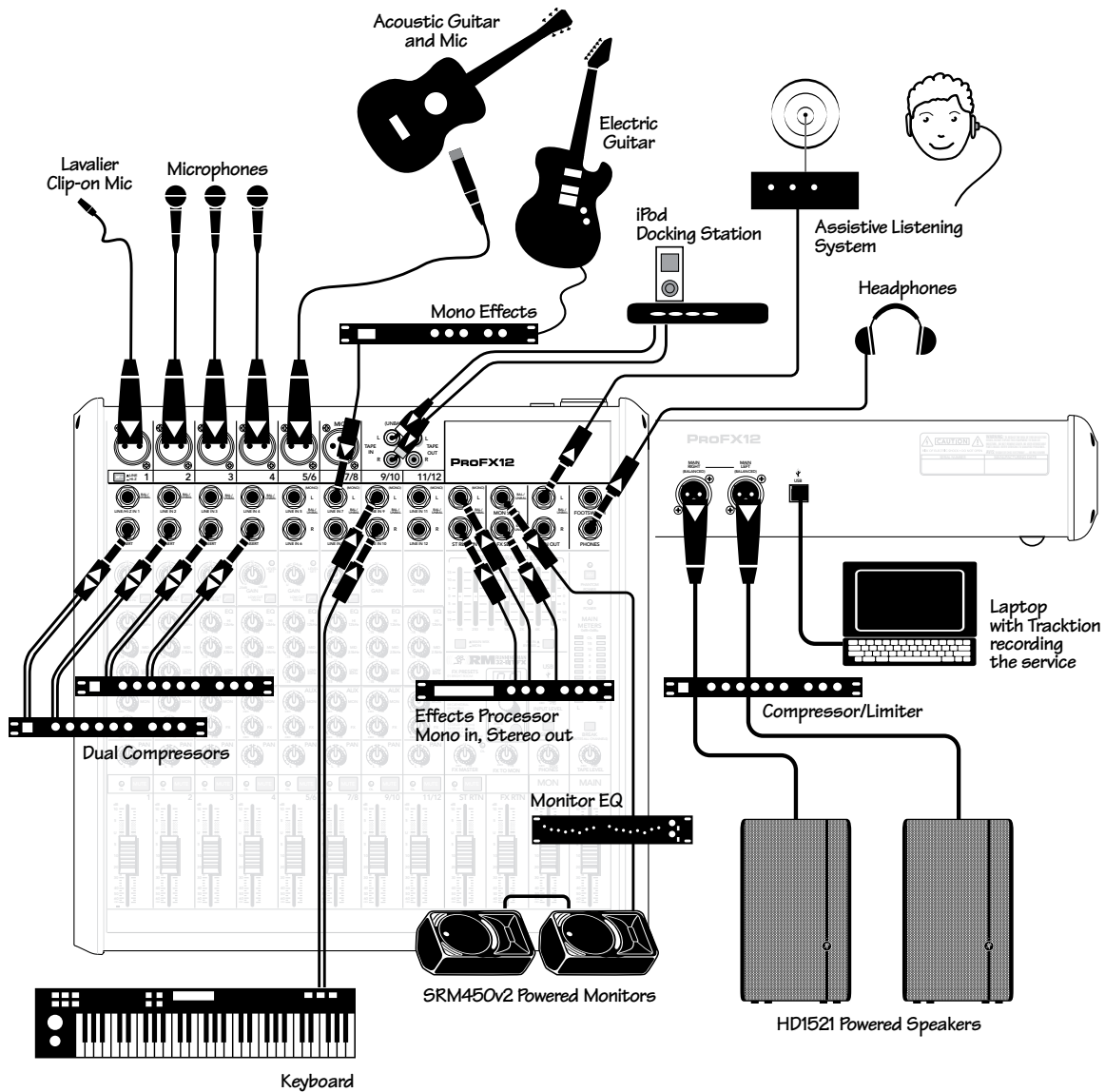

This diagram shows various microphones attached to channels 1 to 4, a mic'd guitar on channel 5/6, a guitar effects processor connected to the left line-level input of channel 7/8 and a keyboard attached to channel 9/10's line-level inputs. An iPod docking station is attached to the stereo tape inputs. An effects processor receives a mono input from the FX send and its stereo outputs connect to the stereo return inputs. An assistive listening system is connected to the line-level main output. Dual compressors are connected to the inserts of channels 1 to 4, allowing vocal compression.

Mackie HD1521 powered speakers are connected to the left and right main output via a compressor/limiter. Two SRM450v2 powered speakers are set up as stage monitors and connect to the mixer's monitor output via a graphic EQ. The aux mon controls of each channel allow you to create a stage monitor mix that is independent of the main mix. Use the external graphic EQ to adjust the stage monitor EQ, as desired. Headphones are used for monitoring.

A laptop connects to the USB port, and allows the 2-channel main mix of the service to be recorded using Traktion software. Two channels of audio can also play from the computer to the main mix.

House of Worship System ProFX12

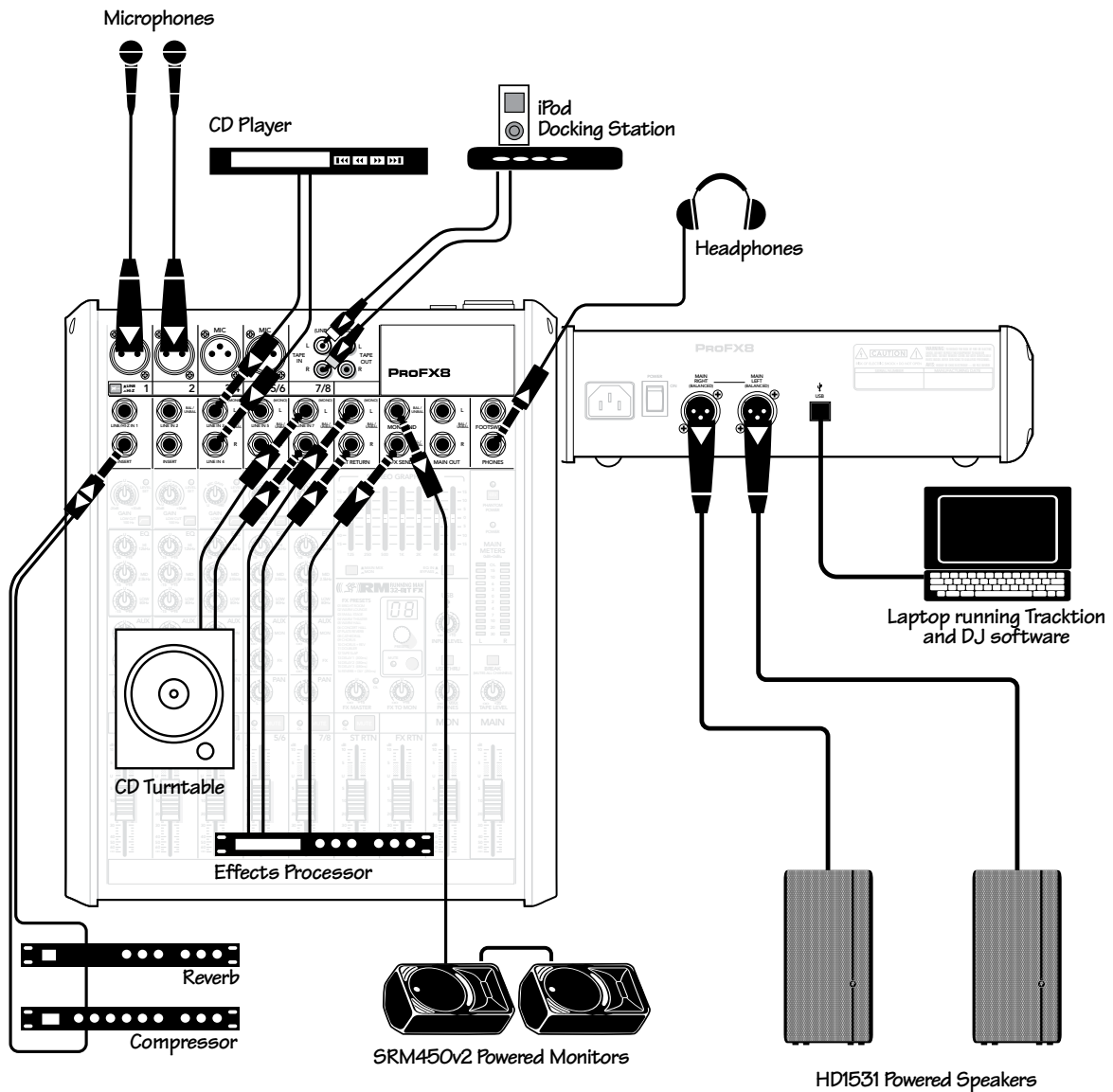

This diagram shows two microphones attached to channels 1 and 2, a CD player connected to the line-level inputs of channel 3/4 and a CD turntable connected to the line-level inputs of channel 7/8. An iPod docking station is attached to the stereo tape inputs. An effects processor receives a mono input from the FX send and its stereo outputs connect to the stereo return inputs. A reverb and compressor are connected to the insert of channel 1 allowing vocal compression and a touch of reverb.

Mackie HD1531 powered speakers are connected to the left and right main output. Two SRM450v2 powered speakers are set up as stage monitors and connect to the mixer's monitor output. The aux mon controls of each channel allow you to create a stage monitor mix that is independent of the main mix. Switch the internal graphic EQ to adjust the stage monitor EQ if desired. Headphones are used for monitoring.

A laptop connects to the USB port and allows 2-channel output of DJ software to play in the main mix. It may also be used to record a set on the computer for posterity.

DJ System ProFX8

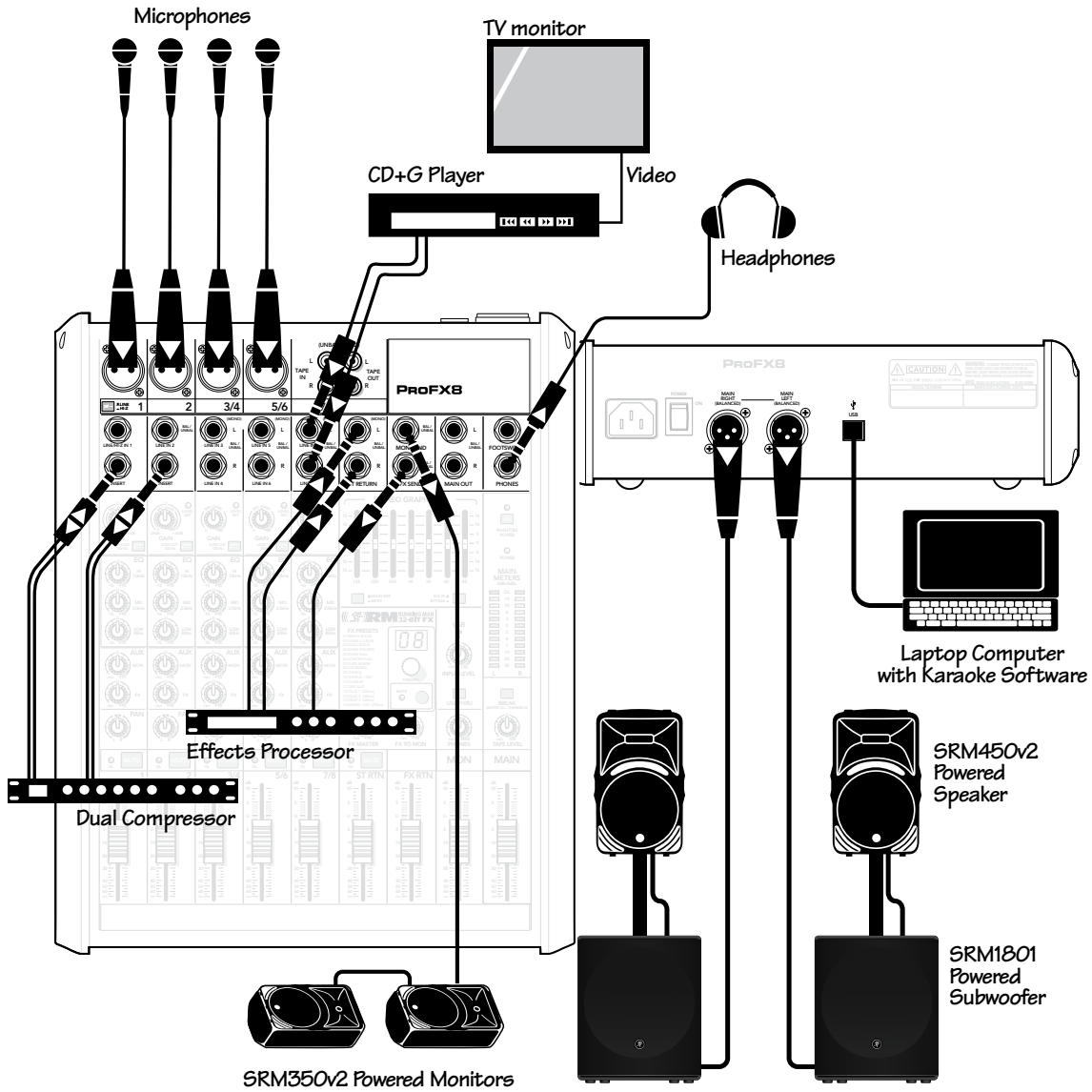

This diagram shows microphones attached to channels 1 to 4 and a CD+G player connected to the line-level inputs of channel 7/8. An effects processor receives a mono input from the FX send and its stereo outputs connect to the stereo return inputs. A dual compressor is connected to the insert of channel 1 and 2, allowing vocal compression.

Mackie SRM450v2 powered speakers and SRM1801 powered subwoofers are connected to the left and right main output. Two SRM450v2 powered speakers are set up as stage monitors and connect to the mixer's monitor output. The aux mon controls of each channel allow you to create a stage monitor mix that is independent of the main mix. Headphones are used for monitoring.

A laptop running Karaoke software connects to the USB port and allows a 2-channel output to play in the main mix.

The CD+G player allows karaoke text and graphics to be displayed on the TV monitor.

Karaoke System ProFX8

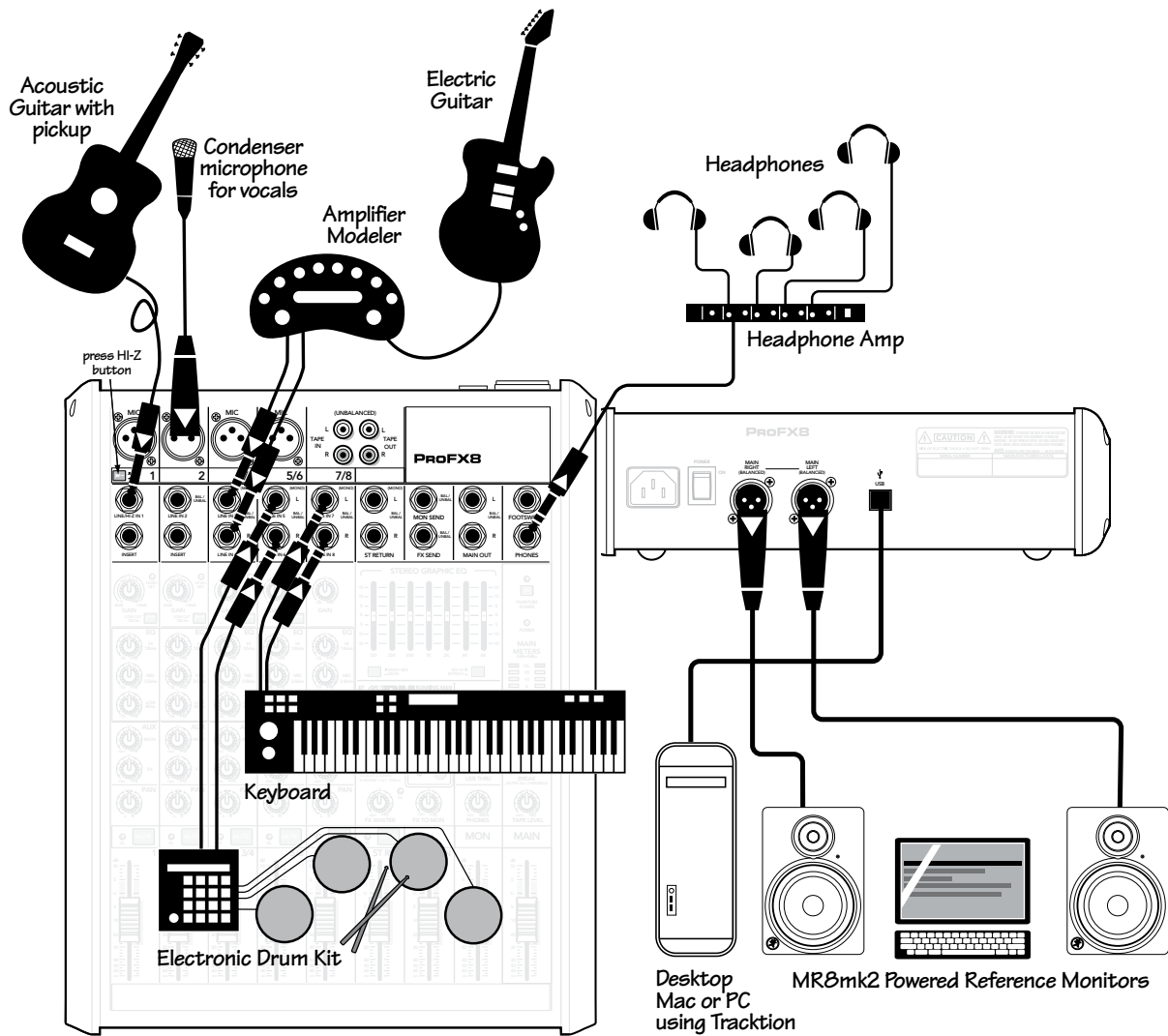

This diagram shows an acoustic guitar connected directly to channel 1 (with the hi-z switch pressed in), a condenser microphone attached to the channel 2 mic input, a guitar amplifier modeler connected to the line-level inputs of channel 3/4, an electronic drum kit connected to channel 5/6 and a keyboard attached to channel 7/8.

Mackie MR8mk2 powered reference monitors are connected to the left and right main output for careful and accurate monitoring of the performance.

A desktop computer connects to the USB port and allows the 2-channel main mix to be recorded and 2 channels to be played back using Traktion software.

Home Studio System ProFX8

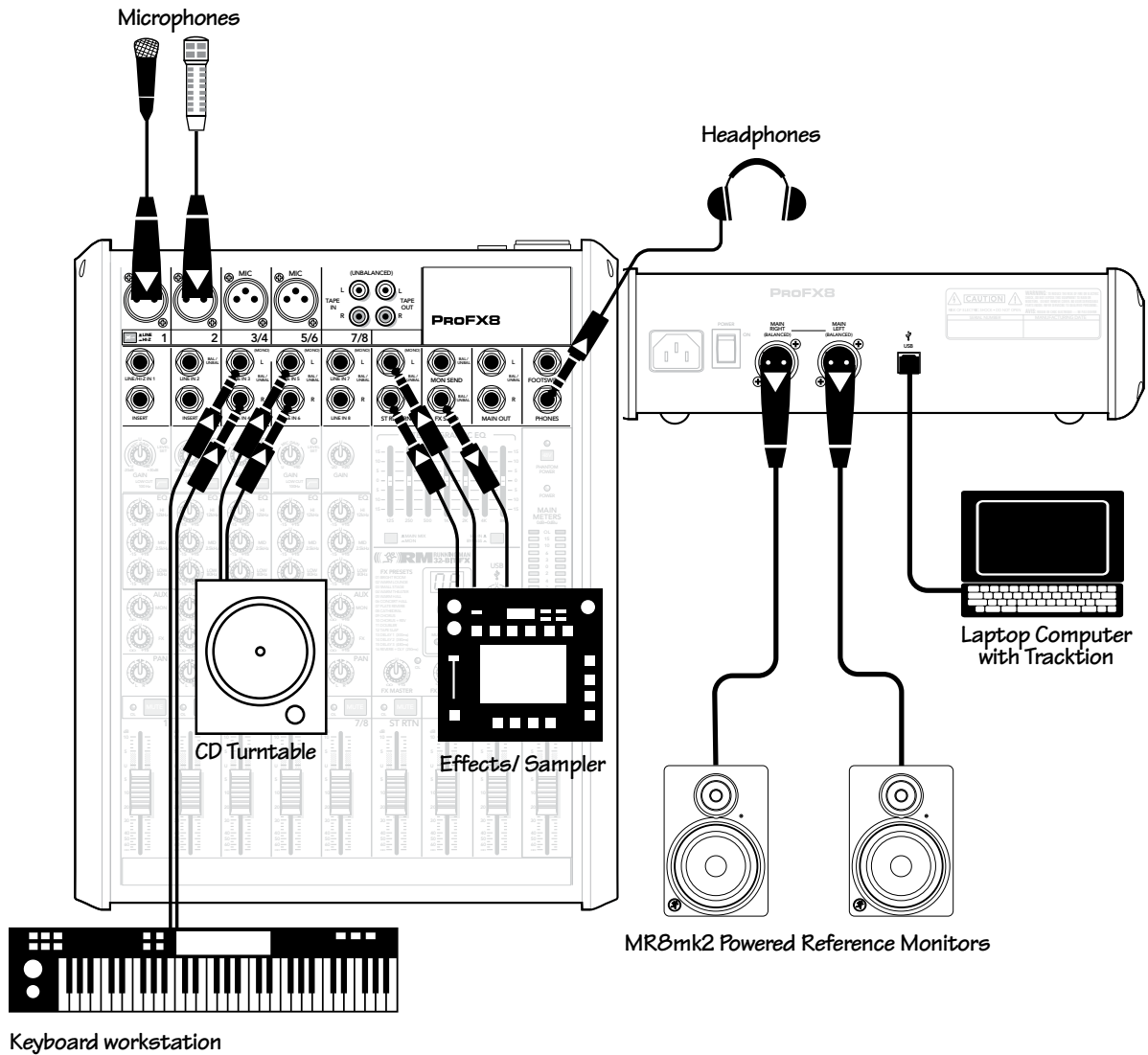

This diagram shows microphones attached to the channel 1 and 2 mic inputs, a keyboard workstation attached to channel 3/4's line-level inputs and a CD turntable connected to channel 5/6's line-level inputs. An effects/sampler receives a mono input from the FX send and its stereo outputs connect to the stereo return inputs.

Mackie MR8mk2 powered reference monitors are connected to the left and right main output for careful and accurate monitoring.

A desktop computer connects to the USB port and allows the 2-channel main mix to be recorded and 2 channels played back using Traktion software.

Podcast System ProFX8

Rear Panel Features

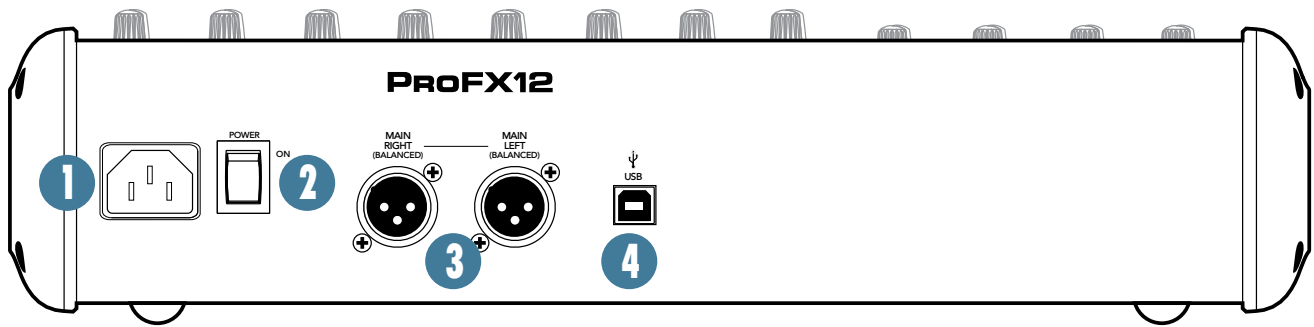

1. POWER CONNECTION

This is a standard 3-prong IEC AC power connector. Securely connect the supplied detachable linecord here and plug the other end into an AC outlet. The mixer has a universal power supply that may accept any AC voltage ranging from 100 VAC to 240 VAC. No need for voltage select switches or step-up or step-down transformers; it will work virtually anywhere in the world. It is less susceptible to voltage sags or spikes than conventional power supplies and provides greater electromagnetic isolation and better protection against AC line noise.

2. POWER SWITCH

Press the top of this rocker switch to turn on the mixer. The front panel power LED [32] will glow with happiness...or at least it will if the mixer is plugged into a suitable live AC mains supply.

Press the bottom of this switch to put the mixer into standby mode. It will not function, but the circuits are still live. To remove AC power, either turn off the AC mains supply, or unplug the power cord from the mixer and the AC mains supply.



As a general guide, turn on the mixer first, before any external power amplifiers or powered speakers, and turn it off last. This will reduce the possibility of any turn-on or turn-off thumps in the speakers.

3. XLR MAIN OUTS

These XLR connectors provide stereo line-level signals from the main mix. Connect these to the balanced inputs of the powered speakers, or to the power amplifier powering the main speakers.

The main mix is the sum of all active channels currently playing, including any 2-channel USB input from the computer. How much of a channel that is heard in the main mix is determined by that channel's fader [30].



The XLR outputs are 6 dB higher output than the 1/4" TRS main outputs [14]. Balanced connections offer better immunity to external noise (specifically, hum and buzz) than unbalanced connections. Because of this, it is the preferred interconnect method, especially where very long lengths of cable are being used.

4. USB PORT

The USB serial I/O interface allows digital audio to transfer to and from a computer.

The interface provides two audio outputs to the computer:

- Main mix output, left and right. These output signals are independent of any adjustments made to the main fader [47] and graphic EQ [36]. This allows you to easily record live performance directly to a laptop.
- The USB thru switch [40] allows you to also include the output from your computer in your recording. See page 23 for more details of this switch.

The computer may also playback two channels into the mixer via the USB interface:

- Left and right signals from the computer are added to the main mix. The USB input level control [39] allows you to adjust the level of the incoming audio from the computer being added to the main mix.

Front Panel Features

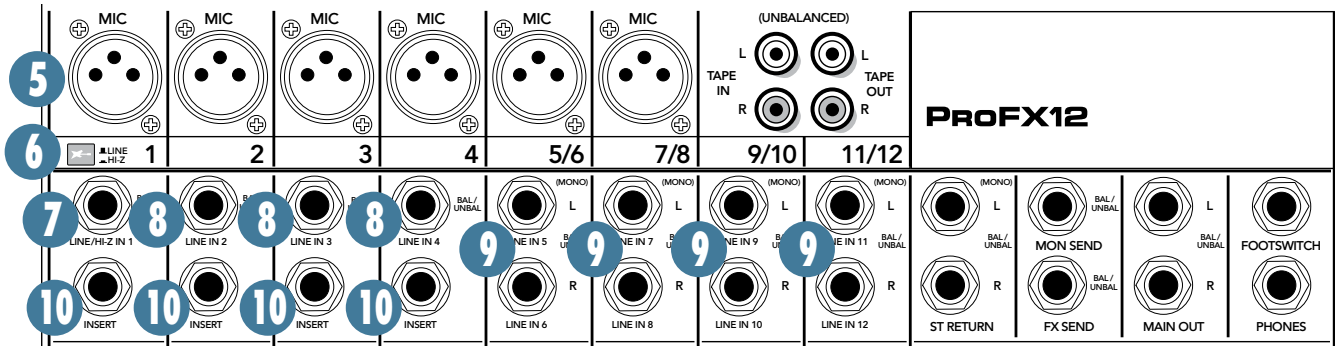

Connection Section

This is where to plug things in: microphones, line-level instruments and effects, headphones, and the ultimate destination for your sound: PA system, stage monitors, effects processors, CD player/recorder, etc.

See Appendix B for further details and drawings of the connectors to use with the ProFX mixer.

5. MIC INPUTS

We use phantom-powered, balanced microphone inputs just like the big studio mega-consoles for exactly the same reason: This kind of circuit is excellent at rejecting hum and noise. You can plug in almost any kind of mic that has a standard XLR male mic connector.

Professional ribbon, dynamic and condenser mics will all sound excellent through these inputs. The ProFX mixer's mic inputs will handle any kind of mic level tossed at them without overloading. Be sure to perform the gain-setting procedure mentioned on page 3.

PHANTOM POWER

Most modern professional condenser mics require phantom power which lets the mixer send low-current DC voltage to the mic's electronics through the same wires that carry audio. (Semi-pro condenser mics often have batteries to accomplish the same thing.) "Phantom" owes its name to an ability to be "unseen" by dynamic mics (Shure SM57/SM58, for instance), which don't need external power and aren't affected by it, anyway.

The ProFX mixer's phantom power is globally controlled by the phantom power switch [31]. (This means that phantom power for all mic inputs is turned on and off together.)

 Never plug single-ended (unbalanced) microphones or ribbon microphones into the mic input jacks if phantom power is on. Do not plug instrument outputs into the mic input jacks with phantom power on unless you know for certain it is safe to do so.

6. LINE/HI-Z SWITCH

To connect a guitar directly to the mixer without using a DI Box, press this switch in first; then connect the output from the guitar to channel 1's 1/4" TRS input [7]. The input impedance is optimized for direct connection and high-frequency fidelity is assured.

In the out position, channel 1's 1/4" TRS input becomes a line input just like the other mono line inputs [8].

To use guitars or other instruments on other channels, you will need to use an external DI box first. Without the DI box – or if this switch is not pressed in – guitars may sound dull and muddy.

7. LINE/HI-Z INPUT (Channel 1 only)

This 1/4" jack shares circuitry (but not phantom power) with the mic preamp and may be driven by balanced or unbalanced sources.

To connect a balanced line to this input, use a 1/4" Tip-Ring-Sleeve (TRS) plug.

To connect an unbalanced line to this input, use a 1/4" mono (TS) phone plug or instrument cable.

This line-level input may also accept instrument-level signals if the hi-z switch [6] is pressed in. This allows you to connect guitars directly into channel 1 without the need for a DI box.

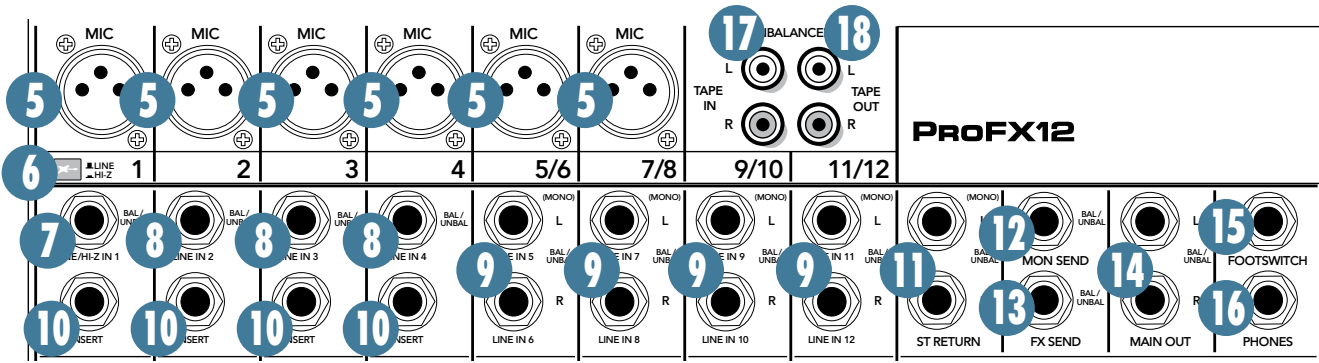

8. MONO LINE INPUTS

These 1/4" jacks share circuitry (but not phantom power) with the mic preamps and may be driven by balanced or unbalanced sources.

To connect balanced lines to these inputs, use a 1/4" Tip-Ring-Sleeve (TRS) plug.

To connect unbalanced lines to these inputs, use a 1/4" mono (TS) phone plug or instrument cable.



If using a stereo source, and the stereo and hybrid channels are in use, utilize two mono channels instead. Traditionally, an odd-numbered channel receives the left signal. For example, feed the ProFX mixer a stereo signal by inserting the device's left output plug into the channel 1 jack (panned fully left) and its right output plug into the channel 2 jack (panned fully right).

9. STEREO LINE INPUTS

These 1/4" jacks may be driven by stereo or mono, balanced or unbalanced sources. They may be used with just about any professional or semi-pro instrument, effect or tape player.

To connect balanced lines to these inputs, use a 1/4" Tip-Ring-Sleeve (TRS) plug.

To connect unbalanced lines to these inputs, use a 1/4" mono (TS) phone plug or instrument cable.

If using just a mono source, plug it into the left input (labeled mono) and the signal will appear (as if by magic) equally on the left and right of the main mix.

10. CHANNEL INSERT

These unbalanced 1/4" jacks are for connecting serial effects processors such as compressors, equalizers, de-essers, or filters.

We've included inserts for just the mono channels. If using this kind of processing on other channels, simply patch through the processor before plugging into the ProFX mixer.

The insert point is after the gain control [19], level set LED [20] and low cut switch [21], but before the channel EQ [22-24] and fader [30]. The channel signal may go out of the insert jack to an external device, be processed (or whatever) and come back in on the same insert jack. To do this requires a special insert cable that must be wired thusly:

- Tip = send (output to effects device)
- Ring = return (input from effects device)
- Sleeve = common ground

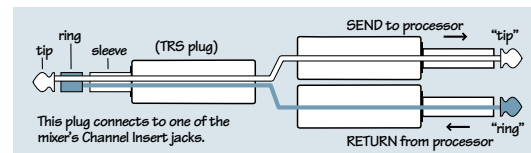

Insert jacks may be used as channel direct outputs; post-gain, and pre-EQ. See the connector section on page 28 (figure F) showing three ways to use insert connections.

11. STEREO RETURN

This is where to connect the outputs of parallel effects devices (or extra audio sources). The circuits will handle stereo or mono, balanced or unbalanced signals. They may be used with just about any pro or semi-pro effects device or line-level source on the market. The signals coming into these inputs may be adjusted using the stereo return fader [44] before passing onto the main mix bus (see page 23). Signals coming in here may also be quickly muted with the mute switch [43], and the OL LED [42] will illuminate if the incoming signal is too high.

Stereo Device: If using a stereo parallel effects device (two cords), use stereo return left and right.

Mono Device: If using an effects device with a mono output (one cord), plug that into the stereo return left/mono, and leave the right unplugged. The signal will be sent to both sides, magically appearing in the center as a mono signal.

12. MON SEND

Stage monitors allow the talented musicians to hear themselves clearly on stage, and this can often be a good thing. The monitor mix may be carefully adjusted in level using the aux mon controls [25]. These tap a portion of each channel's signal to provide a 1/4" TRS output here to feed external stage monitors. These could either be passive stage monitors powered by an external amplifier, or powered stage monitors with their own amplifier built in.

The monitor signal is the sum (mix) of all the channels whose aux mon control is set to more than minimum. If they want "more me, and less Keith," you should turn up their channel's aux mon control, and turn down Keith's.

The overall output level may be adjusted with the monitor fader [46] and its EQ tweaked with the graphic EQ [36] if the main mix/mon switch [37] is pressed in. Alternatively, an external graphic EQ may be added between this output and the powered monitors. This allows you to adjust the EQ and minimize the chance of feedback from nearby microphones.

The monitor output is not affected by the main fader [47] or the channel faders [30]. This allows you to set up the monitor mix and level just right, and not have it change when a channel fader or the main mix fader is adjusted. This is known as "pre-fader."

13. FX SEND

This 1/4" TRS line-level output may be used to feed an external effects processor (FX), such as a nice sound effect or delay unit. The output from this jack is an exact copy of what goes into the internal FX processor, being the careful mix of all channels whose aux FX control [26] is turned to more than minimum.

(The processed output of the internal FX does not come out of this output, but is added internally to the main mix or monitor mix.)

The overall output level may be adjusted with the FX master knob [51]. (This knob also effects the level going into the internal FX.)

The output is "post-fader," so any changes to the channel faders [30] will also affect the level going to the external processor.

The processed output from the effects processor is usually returned to the stereo returns [11] or a spare channel where you may carefully mix the original unprocessed channel (dry) and the processed channel (wet). Altering the original channel fader increases both the wet and dry signals and keeps them at the same delicate ratio. (For example, the reverb remains at the same level relative to the original.)

14. 1/4" MAIN OUTS

These outputs feed the main mix out into the waiting world. Amplifiers may be fed this way or through the XLR main outputs [3].

To use these outputs to drive balanced inputs, connect 1/4" TRS (Tip–Ring–Sleeve) phone plugs like this:

Tip = + (hot)
Ring = –(cold)
Sleeve = Ground

To use these outputs to drive unbalanced inputs, connect 1/4" TS (Tip–Sleeve) phone plugs like this:

Tip = + (hot)
Sleeve = Ground

15. FX FOOTSWITCH

This 1/4" TRS connector is where to connect a footswitch. This will allow you to easily mute or un-mute the internal effects, while stamping your foot and looking like you were mad about something. Any latching one-button on/off footswitch will work.

If the internal effects have already been muted with the internal FX mute switch [50], then the footswitch has no effect, but you can still stamp your foot and pout if that helps any. Cultivate that bad-boy image.

16. PHONES

This 1/4" TRS stereo jack will drive any standard headphone to very loud levels. The wiring follows standard conventions:

Tip = Left channel
Ring = Right channel
Sleeve = Common ground

The headphones output is the stereo main mix, not affected by the main fader [47], or the graphic EQ [36].



Warning: When we say the headphone output is loud, we're not kidding. It can cause permanent ear damage. Even intermediate levels may be painfully loud with some earphones. Be careful! Always turn the phones level control [41] all the way down before connecting headphones, adding new sources, or making any other changes. Keep it down until you've put the phones on. Then turn it up slowly.

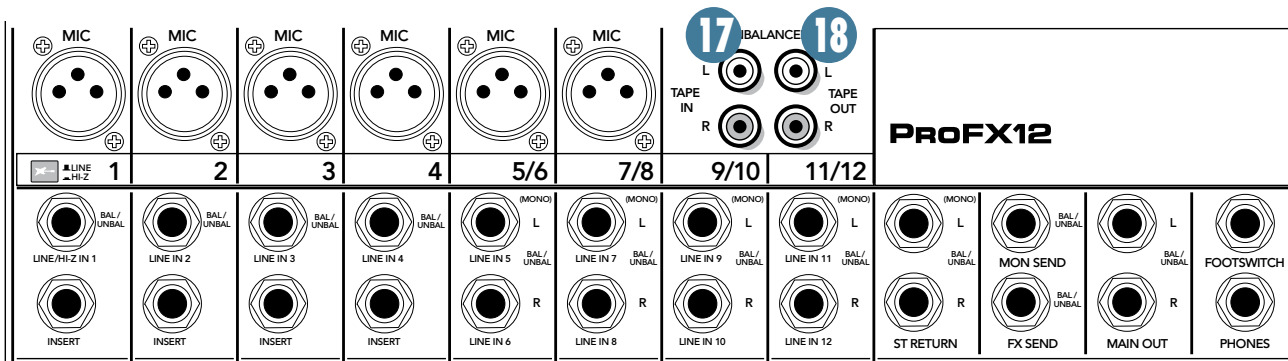

17. TAPE INPUT

These stereo unbalanced RCA inputs are designed to work with semi-pro as well as pro player/recorders. They may also be connected to any standard source with an unbalanced line-level output, such as a CD or DVD player, iPod, and so on.

Connect the source's line-level outputs here using good quality hi-fi (RCA) cables.

These may be used with a tape or CD player to feed music to a PA system between sets when the break switch [34] is engaged. The level coming into the mixer may be adjusted with the tape level knob [35]. For example, press the break switch to mute all channels at once, then play the tape or CD player and bring up its level slowly.

18. TAPE OUTPUT

These stereo unbalanced RCA outputs allow you to record the main stereo mix onto a tape deck, hard disk recorder, automatic CD burner, computer, etc. This allows you to make a recording for posterity/archive/legal purposes whenever the band gets back together again.

The tape output is the stereo main mix, not affected by the main fader [47], or the graphic EQ [36].

ProFX12

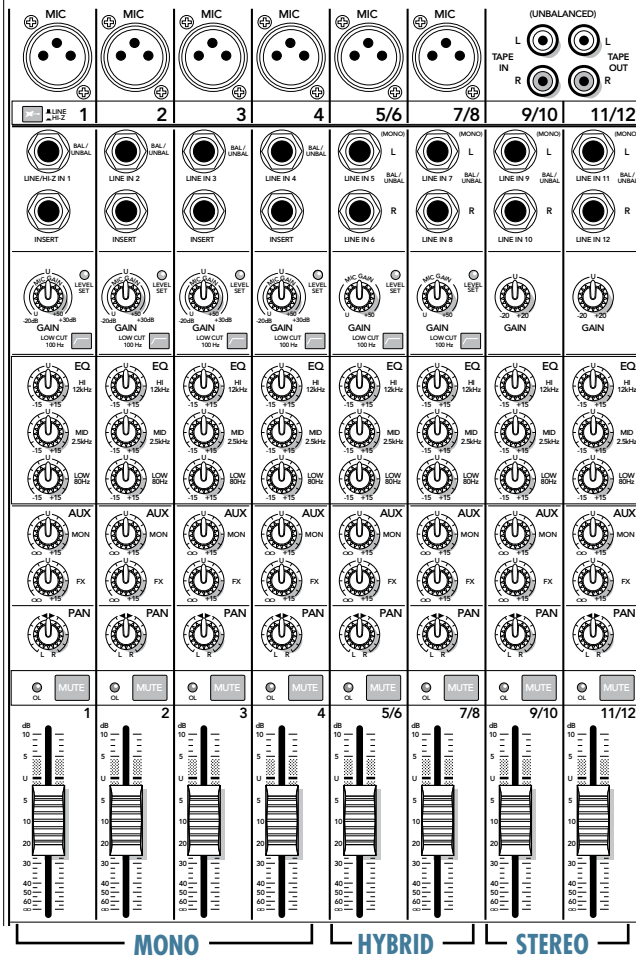

Channel Controls

The vertical channel strips look very similar, with only a few differences between them. Each channel works independently, and just controls the signals plugged into the inputs directly above it. There are three different flavors of channel strip: Mono, Hybrid and Stereo.

Mono Channels (1–4 on ProFX12) (1–2 on ProFX8)

- The mono channel controls affect both the mono mic input and the mono line-level input.
- The gain knob adjusts both mic and line inputs.
- Each mono channel has an insert jack and low cut switch.
- Channel 1 has a hi-z switch to connect a guitar directly.
- The 3-band EQ has shelving high, shelving low, and peaking mid EQ.

Hybrid Channels (5/6, 7/8 on ProFX12) (3/4, 5/6 on ProFX8)

- Except for gain and low cut, these controls affect the mono mic input and the stereo line-level input.
- The gain knob adjusts the mic input only. (The stereo line inputs are fixed at unity gain.)
- The low cut switch only affects the mic input.
- The mono mic input is split equally to the left and right.
- The hybrid channel EQ is a 3-band design just like the mono channel EQ.

Stereo Channels (9/10, 11/12 on ProFX12) (7/8 on ProFX8)

- These controls affect the stereo line-level inputs.
- The gain knob adjusts the left and right line inputs equally. There is no level set LED or low cut switch.
- The stereo channel EQ is a 3-band design just like the mono channel EQ.

“U” LIKE UNITY GAIN

Mackie mixers have a “U” symbol on almost every level control. This “U” stands for “unity gain,” meaning no change in signal level (0 dB gain). Once you have adjusted the input signal with the gain control, set every control at “U” and the signals will travel through the mixer at optimal levels. What’s more, all the labels on our level controls are measured in decibels (dB), so you’ll know what you’re doing level-wise if you choose to change a control’s settings.

ProFX8

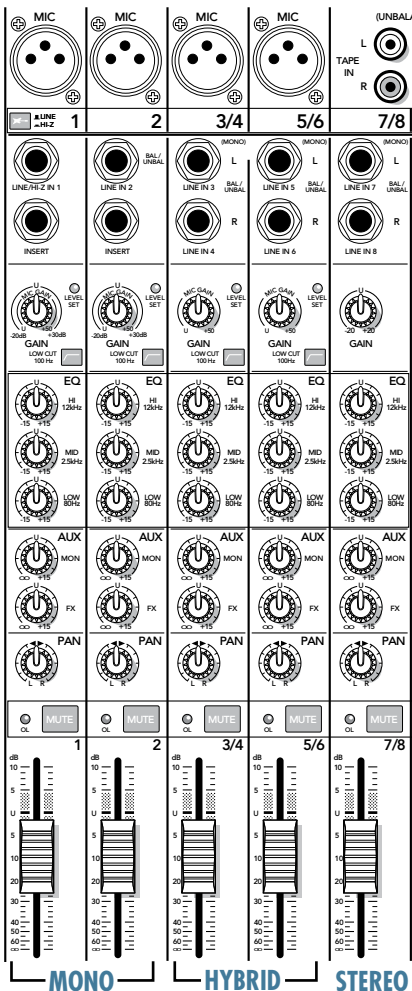

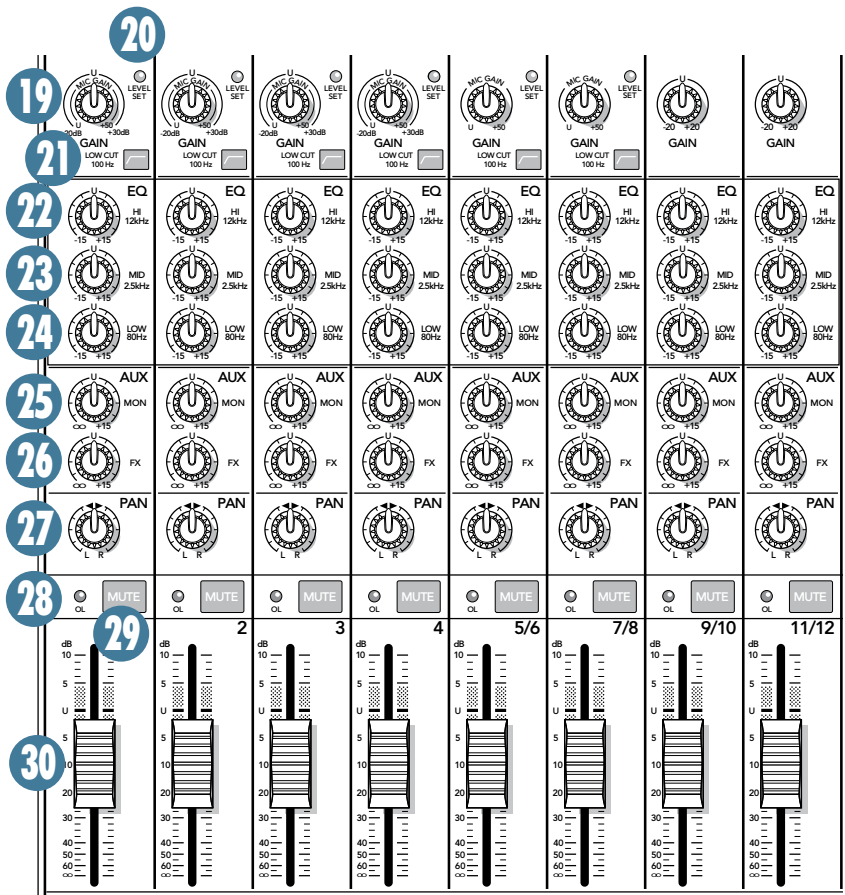

19. GAIN

If you haven't already, please read the gain-setting procedure on page 3. The gain adjustment allows the various source signals from the outside world to be adjusted to the same optimal internal operating levels.

Setting the gain correctly will ensure that the pre-amplifier's gain is not too high, where distortion could occur, and not too low, where the quieter, exquisitely-delicate passages might be lost in background noise.

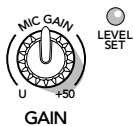

For mono channels (mic input with a mono line input), the gain knob adjusts the input sensitivity of the mic and line inputs.

Adjust the gain control so the level set LEDs [20] illuminate occasionally during the louder moments and are off during the quieter moments.

If the signal comes through the mic XLR jack, there will be 0 dB of gain ("U" for unity) with the knob fully down, ramping to 50 dB of gain fully up.

Through the 1/4" mono input, there is 20 dB of attenuation fully down and 30 dB of gain fully up, with a "U" (unity gain) mark at 12:00. This 20 dB of attenuation can be very handy when inserting a very hot signal, need to add a lot of EQ boost, or both. Without this "virtual pad," this scenario might lead to channel clipping.

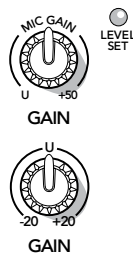

For hybrid channels (mic input and stereo line input), the gain control just affects the microphone input.

For stereo channels (no mic input) the gain control just affects the line-level inputs, with 20 dB of gain, and 20 dB of attenuation. There is no level set LED.

20. LEVEL SET LED

These LEDs are used with the gain control [19] to set the channel preamplifier gain just right for each source.

If one or more channels are distorting, check the level set LEDs. If they are on continuously, turn down the gain.

21. LOW CUT

Each channel with a mic input has a low cut switch that cuts the bass frequencies below 100 Hz, at a rate of 18 dB per octave. All mic inputs are affected, as well as the line inputs of the mono channels.

We recommend using low cut on every microphone application except kick drum, bass guitar, and bassy synth patches. These aside, there isn't much down there that you want to hear, and filtering it out makes the low stuff you do want much more crisp and tasty. Not only that, low cut can help reduce the possibility of feedback in live situations and help to conserve the amplifier power.

Another way to consider low cut's function is that it actually adds flexibility during live performances. With the addition of low cut, you may safely use low EQ on vocals. Many times, bass shelving EQ can really benefit voices. Trouble is, adding low EQ also boosts stage rumble, mic handling clunks and breath pops. Applying low cut removes all those problems so you can add low EQ without blowing the subwoofers.

3-BAND EQ

The ProFX mixer has 3-band equalization at carefully selected points — low shelving at 80 Hz, mid peaking at 2.5 kHz, and high shelving at 12 kHz. “Shelving” means that the circuitry boosts or cuts all frequencies past the specified frequency. For example, rotating the low EQ knob 15 dB to the right boosts bass starting at 80 Hz and continuing down to the lowest note you never heard. “Peaking” means that certain frequencies form a “hill” around the center frequency — 2.5 kHz in the case of the mid EQ.

The following graphs of frequency vs. signal level show the approximate overall effect of EQ adjustment on the frequency range.

22. HI EQ

This control gives you up to 15 dB boost or cut above 12 kHz, and it is flat (no boost or cut) at the detent. Use it to add sizzle to cymbals, and an overall sense of transparency, or edge to keyboards, vocals, guitar and bacon frying. Turn it down a little to reduce sibilance, or to hide tape hiss.

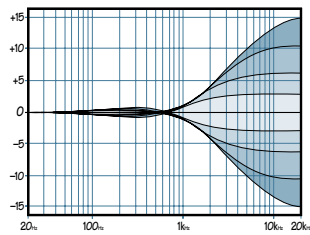

Hi EQ

23. MID EQ

Short for “midrange,” this knob provides 15 dB of boost or cut, centered at 2.5 kHz, also flat at the center detent. Midrange EQ is often thought of as the most dynamic, because the frequencies that define any particular sound are almost always found in this range. You can create many interesting and useful EQ changes by turning this knob down as well as up.

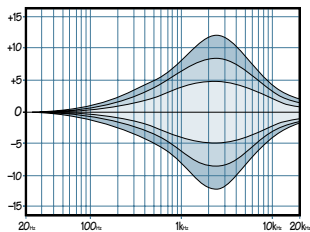

Mid EQ

24. LOW EQ

This control gives you up to 15 dB boost or cut below 80 Hz. The circuit is flat at the center detent position. This frequency represents the punch in bass drums, bass guitar, fat synth patches, and some really serious male singers.

Used in conjunction with the low cut [21] switch, you can boost the low EQ without injecting a ton of subsonic debris into the mix.

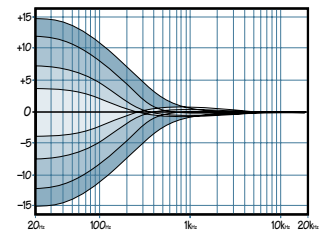

Low EQ

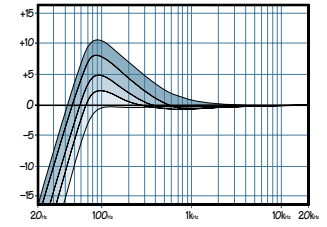

Low EQ with Low Cut

MODERATION DURING EQ

With EQ, things may be upset royally. We've designed a lot of boost and cut into each equalizer circuit, because we know everyone will occasionally need that. But if the EQs are maxed on every channel, the resulting mix is mush. Equalize subtly and use the left sides of the knobs (cut), as well as the right (boost). Very few platinum-record-album engineers ever use more than about 3 dB of EQ. If more than that is necessary, there's usually a better way to get it, such as placing a mic differently (or using a different kind of mic entirely).

25. AUX MON

These knobs tap a portion of each channel's signal to set up a nice monitor mix feeding stage monitors, independent of the main mix. Adjust these controls on each channel until the band is happy with the stage monitor mix.

The aux mon feed from hybrid and stereo channels is a mono sum of the left and right sides of these channels.

The controls are off when turned fully down, deliver unity gain at the center detent, and can provide up to 15 dB of gain turned fully up.

The channel fader [30], pan [27] and mute [29] do not affect the monitor output, but the other channel controls will. (The aux mon is pre-fader.)

The monitor signal from the monitor output jack [12] is the sum (mix) of all the channels whose aux mon control is set to more than minimum. The overall output level may be adjusted with the monitor fader [46] and its EQ tweaked with the graphic EQ [36] if the main mix/mon switch [37] is pressed in. Internal FX may also be added to the monitor mix with the FX to mon knob [53].

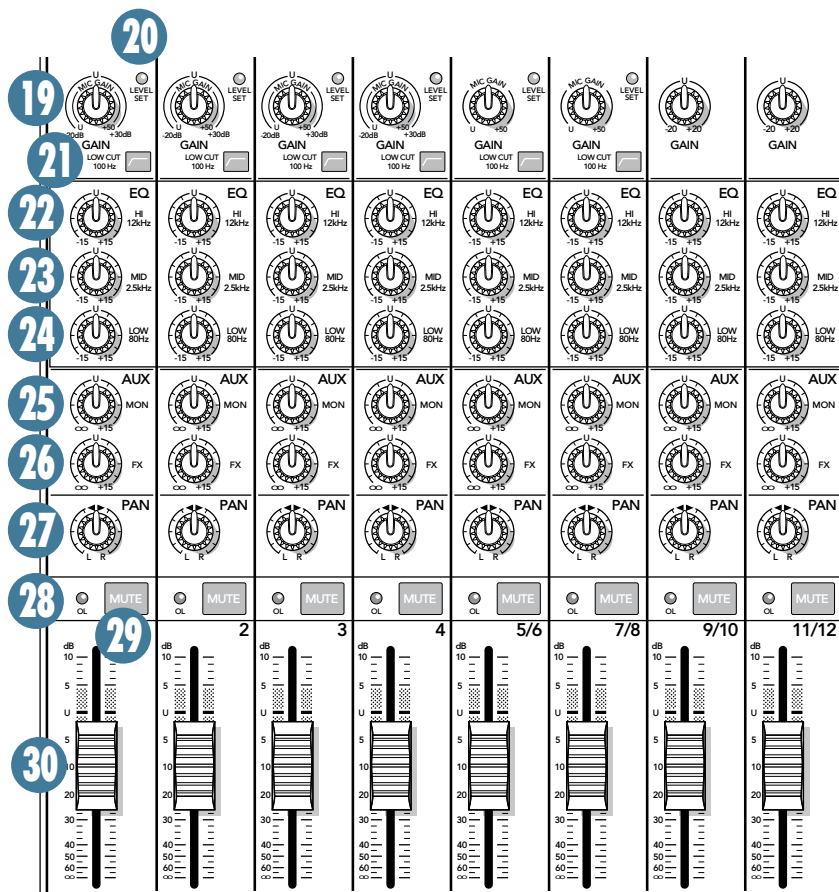

26. AUX FX

These knobs tap a portion of each channel's signal to set up a nice FX mix feeding the internal FX processor, and to feed external processors via the FX output [13].

The aux FX feed from hybrid and stereo channels is a mono sum of the left and right sides of these channels.

The controls are off when turned fully down, deliver unity gain at the center detent, and can provide up to 15 dB of gain turned fully up.

The channel fader [30], mute [29] and other channel controls affect the FX output, but pan [27] does not. (The aux FX is post-fader.)

The FX signal reaching the internal FX processor and the FX send output jack, is the sum (mix) of all the channels whose aux FX control is set to more than minimum. The overall FX send level may be adjusted with the FX master knob [51].

The FX signal from the internal FX processor is added to the main mix using the FX return fader [45], and may be added to the monitors with the FX to mon knob [53].

27. PAN

These knobs adjust the amount of channel signal sent to the left versus the right outputs. On mono channels these controls act as pan pots. On hybrid and stereo channels, they work like the balance control on a home stereo. They do not affect the aux mon or FX mixes.

28. OL LED

This LED will light if the channel signal is too high, and this may cause distortion due to overloading.

The OL LED comes before the channel fader [30] in the signal path, so the fader has no effect in your efforts to turn off the OL LED.

Overloading may occur if the gain [19] is set too high, so check that the level set LED [20] is not turning on frequently. Turn down the gain if it is.

Overloading may also occur if the channel EQ [22-24] is set too high. Check that the EQ settings are moderate. Use the low cut switches [21] if the overloading is due to lower unwanted bass thumps and bangs.

29. MUTE

Press this switch in to mute the channel in the main mix. The aux mon output of the channel is not muted, but the FX output to the internal FX processor and FX send jack [13] is.

30. CHANNEL FADER

These faders control the channel's level from off, to unity gain, on up to 10 dB of additional gain. The mono channels have mono faders, and the hybrid and stereo channels use stereo faders.

With the gain control [19] set correctly, the faders should be set around unity gain (U).

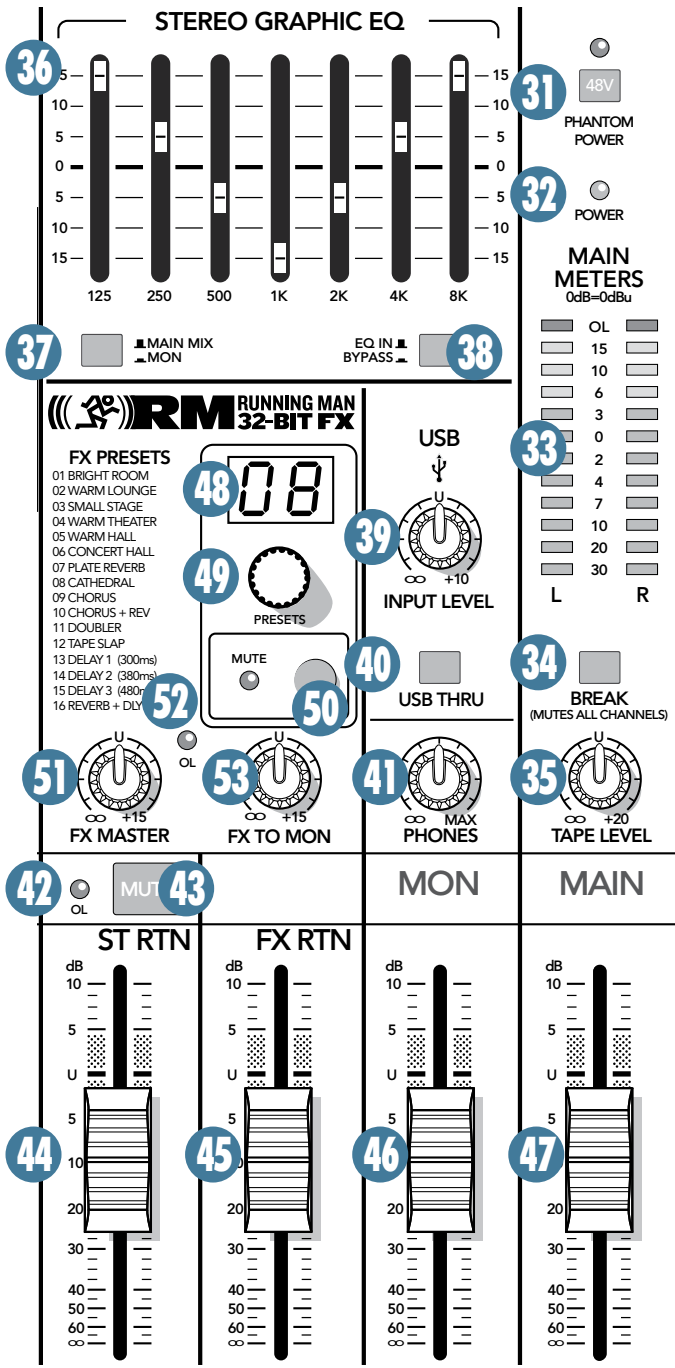

Master Controls

31. PHANTOM POWER SWITCH

If the microphones need phantom power, press in this switch to add phantom power to all the XLR microphone inputs of the mixer. This lets the mixer send low-current DC voltage to the mic's electronics through the same wires that carry audio. The LED will turn on as a reminder that phantom power is engaged.

Most modern professional condenser mics require phantom power. Semi-pro condenser mics often have batteries to accomplish the same thing. "Phantom" owes its name to an ability to be "unseen" by dynamic mics (Shure SM57/SM58, for instance), which don't need external power and aren't affected by it anyway.

VERY IMPORTANT Never plug single-ended (unbalanced) microphones, or ribbon microphones into the mic input jacks if phantom power is on. Do not plug instrument outputs into the mic input jacks with phantom power on, unless you know for certain it is safe to do so.

32. POWER LED

This LED comes on when the mixer is plugged into the AC mains supply, and the rear panel power switch [2] is on.

If the LED does not turn on, make sure the AC power is live, both ends of the power cord are correctly inserted, the electricity bill has been paid and the lights in town are on.

33. METERS

These meters have 2 columns of 12 LEDs each, with dB markings from -30 to +15, and OL (overload at +20 dBu). They indicate the stereo signal strength of the main mix after the main fader [47].

Typically, these meters should be bouncing between the "0" and the "+3" LEDs. It is okay if the OL LEDs light occasionally, but if they light frequently or continuously, turn down the main fader until they blink occasionally or not at all.

Remember, audio meters are just tools to help assure that the levels are "in the ballpark." You don't have to stare at them (unless you want to).

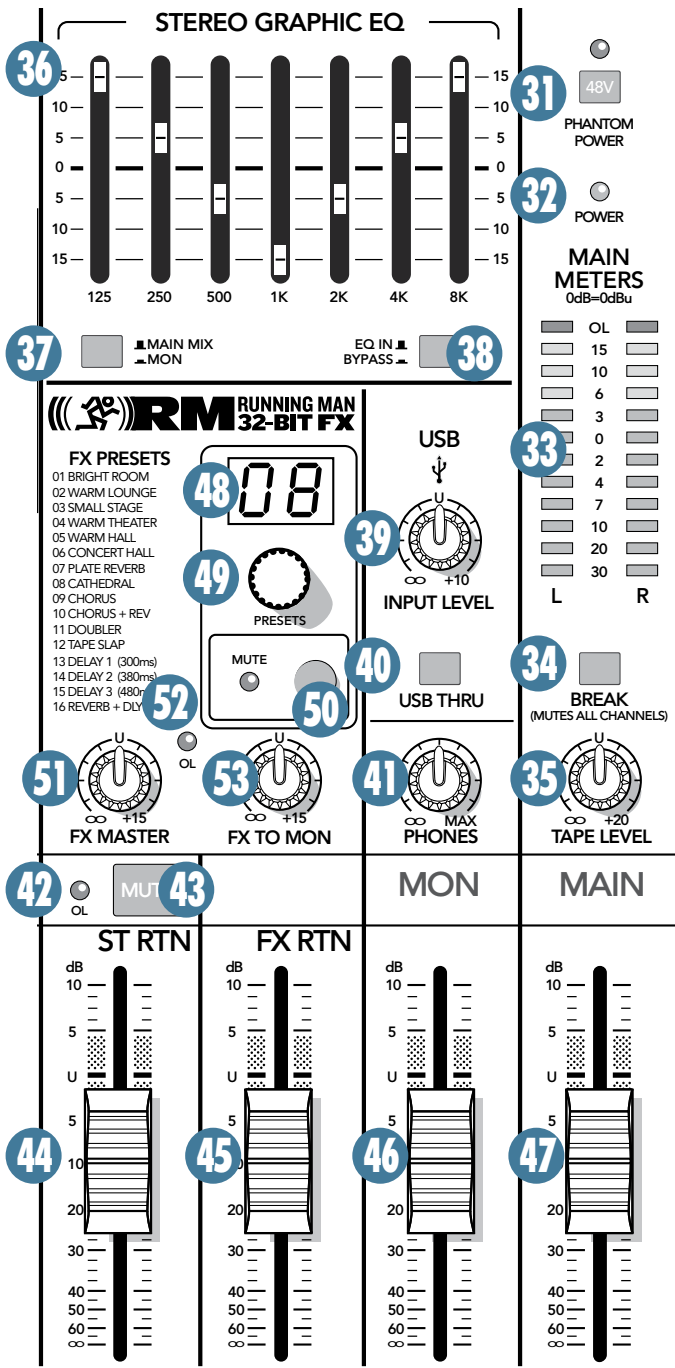

34. BREAK SWITCH

This important “take-a-break” switch quickly mutes all the microphones and line-level inputs when the band is between sets. This will prevent protestors or rogue karaoke singers from storming the stage at the interval. The monitor send [12] and FX send [13] are not affected. Check this switch first if you are having trouble with no sound in the system.

You can still play the stereo RCA tape inputs [17] in the main stereo mix, and play audio coming in from your computer via the USB inputs. For example, you could play a soothing CD while the band is off stage.

35. TAPE LEVEL

This knob controls the input level of signals entering the tape inputs. It is conveniently located close to the break switch [34] so all channels may be quickly muted while bringing up the background music while the band is taking a break.

36. STEREO GRAPHIC EQ

This 7-band graphic equalizer adjusts the main mix output. It affects the line-level outputs [3, 14], but not the tape outputs [18], headphones [16], or the USB output [4]. This EQ may be used for the monitor mix instead of the main mix, if the main mix/mon switch [37] is engaged. It may also be quickly bypassed using the EQ in/bypass switch [38].

Each slider adjusts the level of its frequency band, with up to 15 dB of boost or cut, and no change in level at the center (0 dB) position. The frequency bands are: 125, 250, 500, 1k, 2k, 4k, and 8kHz.

The EQ section comes before the main fader [47] and meters [33]. As with the channel EQ, just take it easy. There is a large amount of adjustment, and if you are not careful, you can upset the delicate balance of nature. Although it may not seem cool to actually turn down controls, with EQ it is often your best option. Turn down the offending frequency range, rather than boost the wanted range. Use it to reduce the level of some frequency bands where feedback occurs.

37. MAIN MIX/MON

Use this switch to choose if the stereo graphic EQ [36] is used for the stereo left and right main mix or if it is used for the monitors. For example, there may be times when the graphic EQ may be used wisely in the monitor mix to reduce feedback in the monitors from nearby microphones.

38. EQ IN/BYPASS

Use this switch to quickly engage or disengage the stereo graphic EQ. This may be used for quick checks of EQ settings or to shorten the signal path if not using the EQ.

39. USB INPUT LEVEL

This control adjusts the signal level of the two channels coming in from the computer, via the USB port, relative to the mix of the other channels. Adjust it carefully to achieve the desired mix with the other channels.

The USB input from audio software such as Tracktion, could be individual instrument tracks, a mix of tracks, or processed tracks.

40. USB THRU

In addition to a mix of the other channels, the USB output to the computer may contain any input from the computer if this switch is down. (This switch only affects the output to the computer, not the headphones or main mix.)

- If disengaged (out), the USB output to the computer will just be the main mix. This is a good position for overdubbing, as any playback from the computer may be played through the main speakers and headphones, while playing along with a guitar and recording only the guitar via USB. This is also good for live recording as a safeguard against feedback. Here, the USB level knob should also be down.
- If pressed in, the USB output to the computer will be the main mix, including any audio coming in from the computer. This is a good position to record live performances where playback of audio from the computer is also part of the performance.

41. PHONES LEVEL

This controls the volume of the headphones output from off to maximum gain.



Warning: The headphone amplifier is designed to drive any standard headphones to a very loud level. It can cause permanent

hearing damage. Even intermediate levels may be painfully loud with some headphones. Be careful! Always start with the phones level control turned all the way down before connecting headphones or making any connections. Keep it down until you've put on the headphones, and turn it down first whenever you play a new source or instrument.

42. OL LED (for stereo returns)

This LED will light if the signal coming into the stereo return inputs [11] is too high, and this may cause distortion due to overloading.

The OL LED comes before the stereo return fader [44], so the fader has no effect in your efforts to turn off the OL LED.

Check external processors and other devices, and turn down their levels until the OL LED does not come on.

43. MUTE (for stereo returns)

Press this switch in to mute the signals coming into the stereo return inputs [11].

44. STEREO RETURN FADER

Use this fader to lovingly adjust the level of any audio coming into the stereo return inputs [11] from external processors or other equipment. The audio is added to the main mix and it may also be muted with the stereo return mute switch [43].

Typically, this fader can just live at the unity “U” mark, and the external device’s output control set at whatever they call unity gain (check the manual of the effects unit, CD player, drum machine, or whatever). If that turns out to be too loud or too quiet, adjust the external device’s outputs, not the mixer. That way, the mixer’s faders are easy to relocate at the unity “U” mark. The range is off to +10 dB.

45. FX RETURN FADER

Use this fader to gently adjust the level of the stereo output from the internal FX processor being added to the main mix. The range is off to +10 dB with unity at “U”.

46. MONITOR FADER

This fader controls the overall level of the monitor send signal sent out to the stage monitors.

Adjust it carefully and check that the band is happy with the levels. The fader does not affect the main mix level.

The monitor send signals are off with the fader fully down, the “U” marking is unity gain, and fully up provides 10 dB of additional gain.

47. MAIN FADER

This fader controls the level of the main mix and affects the meters [33] and main line-level outputs [3, 14]. The level adjustment occurs after the stereo graphic EQ [36] in the signal path.

This gives you ultimate control over the audience. Adjust it carefully, with a good eye on the meters to check against overloading and a good ear on the levels to make sure the audience is happy.

The control does not affect the monitor send [12], tape output [18], headphones [16], or USB output [4].

The main mix signals are off with the fader fully down, the “U” marking is unity gain and fully up provides 10 dB of additional gain. This additional gain will typically never be needed, but once again, it’s nice to know it’s there. The level control is stereo, as it affects both the left and right of the main mix equally. This is the control to turn down at the end of the song when you want “The Great Fade-Out.”

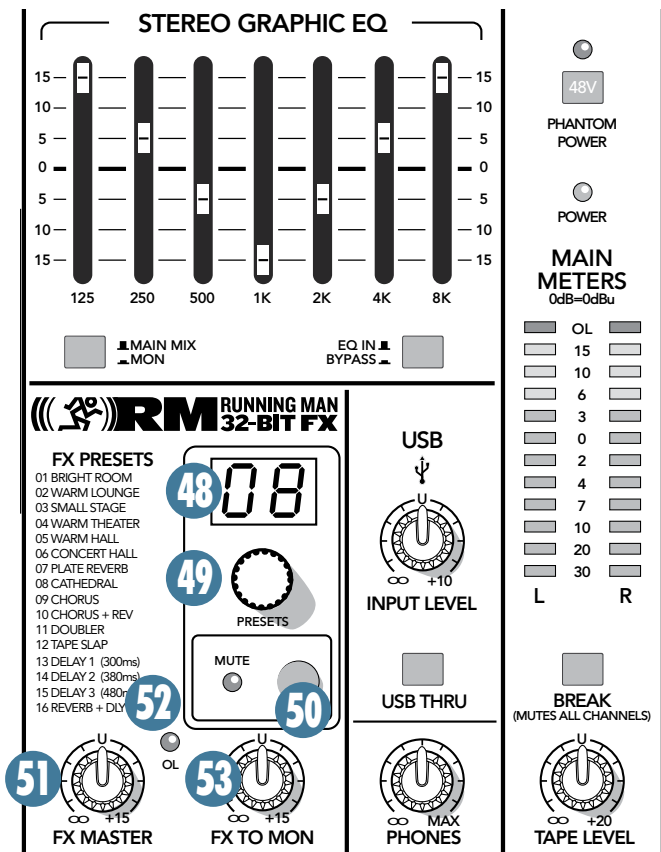

Stereo Effects Processor

The Mackie Running-Man 32-bit internal effects processor is a mono-in, stereo-out effects processor, with 16 presets. It is fed by adjusting the aux FX control [26] on each channel. The FX master knob [51] adjusts the overall level entering the FX processor and the OL LED [52] shows if the level is too high.

The output from the processor may be added to the main mix by adjusting the FX return fader [45]. Its output may also be added to the monitor mix by adjusting the FX to mon knob [53].

48. PRESET DISPLAY

This display shows the number of the currently selected effects preset, as shown in the list of presets silkscreened to the left of the display.

49. PRESET SELECTOR

Rotate this knob to increase or decrease the number of the preset. The available presets are shown in the table on the next page and are marked on the panel silkscreen. (Only one preset may be selected at a time.)

50. INTERNAL FX MUTE and LED

When engaged, the internal effects processor is muted. Its output will not appear in the main mix or monitors, and the adjacent LED will come on. The footswitch connection [15] becomes disabled and the footswitch cannot be used to mute or un-mute the effects.

If this switch is not engaged, then the internal effects may be muted or un-muted with a footswitch.

51. FX MASTER

Use this knob to control the level of the signals going into the internal effects processor. Adjust it carefully, with an inner magical eye on the adjacent OL LED [52] to prevent overloading the effects processor.

Fully down is off, 12 o'clock is unity gain, and fully up is 15 dB of gain.

It also affects the level going out of the FX send output [13].

52. OL LED

This LED illuminates when the effects processor is being overloaded with too strong a signal (OL). Turn down the FX master [51] if it is.

The signals going into the processor are affected by the channel aux FX controls [26], and the channel faders [30]. Check the LED if these controls have been altered.

53. FX TO MON

This knob adds the output of the internal FX processor to the stage monitor mix. Fully down is off, 12 o'clock is unity gain, and fully up is 15 dB of gain.

TABLE OF INTERNAL EFFECTS

No.	Title	Description	Example of its use
1	BRIGHT ROOM	This room has a bright tone with lots of scattered reflections to simulate harder, more reflective surfaces.	Useful on vocals that require a brighter reverb to cut through the mix, or for giving acoustic instruments a livelier vibe.
2	WARM LOUNGE	This preset features a medium sized room/lounge sound, with just enough enhancement of the lower mids to produce a warm tone.	Useful for vocals on songs that require a larger, more "wet" sound, or for giving dimension to bright horns without adding harshness.
3	SMALL STAGE	This preset simulates the sound of a small concert stage, with a medium reverb time and reverberant space.	Useful for vocals or guitars in fast paced, high-energy songs that call for a "live" sounding reverberation.
4	WARM THEATER	This reverb has a warm bodied tone and medium long reverb time to simulate the live acoustics of a theater space.	Perfect for vocals, drums, acoustic and electric guitars, keyboards, and more.
5	WARM HALL	This reverb simulates the sound of a spacious, yet cozy, heavily draped and carpeted concert hall with an especially warm tone.	Perfect for adding natural concert hall ambience to close-mic'd orchestral instruments.
6	CONCERT HALL	This hall reverb is characterized by its large, spacious sound, long pre-delay, and vibrant tone.	Adds life to acoustic instruments and vocals from solos to full-on symphonies and choirs.
7	PLATE REVERB	This preset emulates vintage mechanical reverberation that was generated with a metal plate. Its sound is characterized by lots of early reflections and no pre-delay.	Perfect for thickening percussive instruments, such as a snare drum, or tight vocal arrangements.
8	CATHEDRAL	This reverb emulates the extremely long tails, dense diffusion and long pre-delays and reflections that would be found in a very large, stone walled house of worship.	Gives amazing depth to choirs, wind instruments, organs, and soft acoustic guitars.
9	CHORUS	This preset provides a soft, ethereal sweeping effect that is useful for thickening and for making a particular sound pop out of the mix.	Perfect for enhancement of electric and acoustic guitar and bass, or to add a dramatic effect to vocals, particularly group harmonies and choirs.
10	CHORUS + REV	This preset perfectly combines the chorus effect above with a large, roomy reverb.	This lets you both thicken your sound with the chorus effect while adding warmth and spaciousness thanks to the smooth reverb.
11	DOUBLER	This effect simulates the sound of a vocal or instrument being recorded twice (double tracked) on a multi-track recorder. (50MS)	Provides a vibe that is similar to chorus without the subtle swirl.
12	TAPE SLAP	This effect provides a single, relatively rapid delay of the original signal, with the added warmth that vintage tape-based echo units provided. (180 MS)	Often used on vocals for a 1950's era feel, or on guitars for a surf-type tone. Often used by people whose favorite number is 12.
13 14 15	DELAY 1 (300MS) DELAY 2 (380MS) DELAY 3 (480 MS)	These delay presets provide around three repeats of the original signal. The default delay time for each preset is shown in ms – the smaller the time, the faster the delay.	These work best with full, up-beat music like rock where the delay needs to cut through the mix.
16	REVERB + DLY (250MS)	This effect combines the warm theater reverb effect with the echoes of the 3-repeat delay effect.	Perfect for thickening vocals while adding dimension, it can also be used as a spacey effect on electric guitars.

Appendix A: Service Information

If you think your ProFX mixer has a problem, please check out the following troubleshooting tips and do your best to confirm the problem. Visit the support section of our website (www.mackie.com) where you will find lots of useful information such as FAQs, documentation and user forums. You may find the answer to the problem without having to send your mixer away.

Troubleshooting

Bad Channel

- Has the gain been set correctly?
- Is the mute switch on?
- Is the fader turned up?
- Is the channel OL LED on?
- Is the channel EQ set moderately?
- Try unplugging any insert devices.
- Try the same source signal in another channel, set up exactly like the suspect channel.

Bad Output

- Is the associated level fader (if any) turned up?
- Are any OL LEDs on in the channels, main meters or internal FX?
- If it's one of the main outs, try unplugging all the others. For example, if it's the 1/4" left main out, unplug the RCA and XLR left outputs. If the problem goes away, it's not the mixer.
- If it's a stereo pair, try switching them around. For example, if a left output is presumed dead, switch the left and right cords, at the mixer end. If the problem switches sides, it's not the mixer.

Noise

- Turn the channel gain and faders down, one by one. If the sound disappears, it's either that channel or whatever is plugged into it, so unplug whatever that is. If the noise disappears, it's from your whatever.

Power

- Check that the power cord is firmly connected at both ends.

Repair

For warranty service, refer to the warranty information on page 32.

Non-warranty service for Mackie products is available at a factory-authorized service center. To locate your nearest service center, visit www.mackie.com, click "Support" and select "Locate a Service Center." Service for Mackie products living outside the United States can be obtained through local dealers or distributors.

If you do not have access to our website, you can call our Tech Support department at 1-800-898-3211, Monday-Friday, normal business hours, Pacific Time, to explain the problem. Tech Support will tell you where the nearest factory-authorized service center is located in your area.

Appendix B: Connections

"XLR" Connectors

Mackie mixers use 3-pin female "XLR" connectors on all microphone inputs, with pin 1 wired to the grounded (earthed) shield, pin 2 wired to the "high" ("hot" or positive polarity) side of the audio signal and pin 3 wired to the "low" ("cold" or negative polarity) side of the signal. See Figure A. This is all totally aboveboard and in full accord with the hallowed standards dictated by the AES (Audio Engineering Society).

Use a male "XLR"-type connector, usually found on the nether end of what is called a "mic cable," to connect to a female XLR jack.

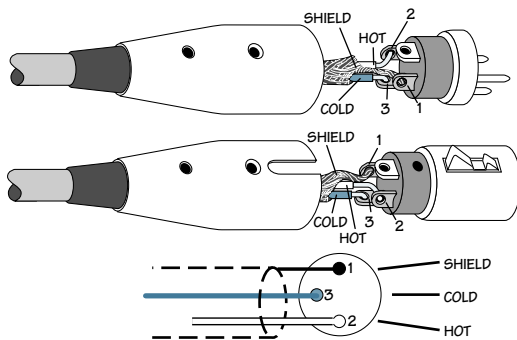

Figure A: XLR Connectors

1/4" TRS Phone Plugs and Jacks

"TRS" stands for Tip-Ring-Sleeve, the three connections available on a "stereo" 1/4" or "balanced" phone jack or plug. See Figure B.

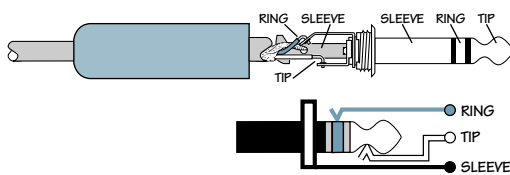

Figure B: 1/4" TRS Plugs

TRS jacks and plugs are used in several different applications:

- Stereo headphones, and rarely, stereo microphones and stereo line connections. When wired for stereo, a 1/4" TRS jack or plug is connected tip to left, ring to right and sleeve to ground (earth). Mackie mixers do not directly accept 1-plug-type stereo microphones. They must be separated into a left cord and a right cord, which are plugged into the two mic preamps.

- Balanced mono circuits. When wired as a balanced connector, a 1/4" TRS jack or plug is connected tip to signal high (hot), ring to signal low (cold), and sleeve to ground (earth).
- Unbalanced Send/Return circuits. When wired as send/return "Y" connector, a 1/4" TRS jack or plug is connected tip to signal send (output from mixer), ring to signal return (input back into mixer), and sleeve to ground (earth).

1/4" TS Phone Plugs and Jacks

"TS" stands for Tip-Sleeve, the two connections available on a "mono" 1/4" phone jack or plug. See Figure C.

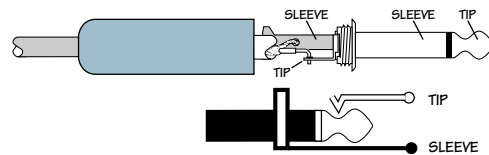

Figure C: TS Plug

TS jacks and plugs are used in many different applications, always unbalanced. The tip is connected to the audio signal and the sleeve to ground (earth). Some examples:

- Unbalanced microphones
- Electric guitars and electronic instruments
- Unbalanced line-level connections

RCA Plugs and Jacks

RCA-type plugs (also known as phono plugs) and jacks are often used in home stereo and video equipment and in many other applications (Figure D). They are unbalanced and electrically identical to a 1/4" TS phone plug or jack (see Figure C). Connect the signal to the center post and the ground (earth) or shield to the surrounding "basket."



Figure D: RCA Plug

TRS Send/Receive Insert Jacks

Mackie's single-jack inserts are the three-conductor, TRS-type 1/4" phone. They are unbalanced, but have both the mixer output (send) and the mixer input (return) signals in one connector. See Figure E.

The sleeve is the common ground (earth) for both signals. The send from the mixer to the external unit is carried on the tip, and the return from the unit to the mixer is on the ring.

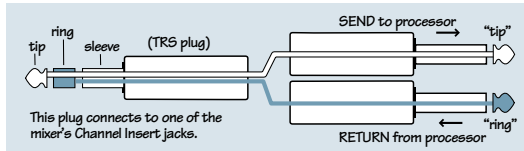

Figure E

Using the Send only on an Insert Jack

If you insert a TS (mono) 1/4" plug only partially (to the first click) into a Mackie insert jack, the plug will not activate the jack switch and will not open the insert loop in the circuit (thereby allowing the channel signal to continue on its merry way through the mixer).

This allows you to tap out the channel or bus signal without interrupting normal operation.

If you push the 1/4" TS plug in to the second click, you will open the jack switch and create a direct out, which does interrupt the signal in that channel. See Figure F.

NOTE: Do not overload or short-circuit the signal you are tapping from the mixer. That will affect the internal signal.

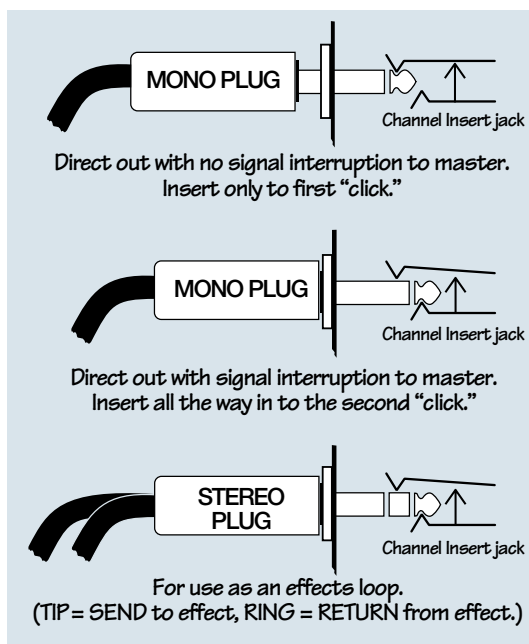

Figure F

Mackie Stereo Inputs and Returns: Mono, Stereo, Whatever

Stereo line inputs and stereo returns are a fine example of the Mackie philosophy (which we just made up) of Maximum Flexibility with Minimum Headache. The inputs and returns will automatically be mono or stereo, depending upon how you use the jacks. Here's how it works:

A mono signal should be patched into the input or return jack labeled left (mono). The signal will be routed to both the left and right sides of the return circuit, and will show up in the center of the stereo pair of buses it's assigned to, or it can be "panned" with the pan control.

A stereo signal, having two plugs, should be patched into the left (mono) and the right input or return jacks. A jack switch in the right jack will disable the mono function, and the signals will show up in stereo.

A mono signal connected to the right jack will show up in the right bus only. You probably will only want to use this sophisticated effect for special occasions.

Appendix C: Technical Information

Specifications

Noise

20 Hz – 20 kHz, 150 Ω Source Impedance	
Equivalent Input Noise	
(Mic in to Insert Send out, max gain)	-125 dBu
Residual Output Noise	
(All outputs, master levels off, all channel levels off)	-95 dBu
(All outputs, master levels unity, all channel levels off)	-80 dBu
(All outputs, master levels unity, one channel level unity)	-80 dBu

Distortion

20 Hz – 20 kHz	
THD+N, SMPTE IMD	
(Mic input to Main output)	<0.03% @ +4 dBu output

Common Mode Rejection Ratio

1 kHz	
(Mic input to Insert Send output)	60 dB gain at unity

Frequency Response

20 Hz – 30 kHz	
(Mic input to any output, gain at unity)	+0 dB / -1 dB

Crosstalk

20 Hz – 20 kHz	
Adjacent Inputs	-90 dB @ 1 kHz
Inputs to Outputs	-90 dB @ 1 kHz
Fader Off	-75 dB @ 1 kHz
Mute Switch/Break Switch Mute	-90 dB @ 1 kHz

Maximum Levels

All Inputs	+22 dBu
Main Mix XLR	+28 dBu
All other outputs	+22 dBu

Impedances

Mic in	3 k Ω
Channel Insert return	10 k Ω
Ch 1 Instrument Input	1 M Ω
All other inputs	20 k Ω
Tape out	1.1 k Ω
Phones out	25 Ω
All other outputs	120 Ω

Maximum Voltage Gain (EQ Flat)

Mic Input Channel to	
Insert Output	50 dB
Tape Output	60 dB
USB Output	50 dB
1/4 Inch Main Output	70 dB
XLR Main Output	76 dB
Monitor Send	75 dB
FX Send	90 dB
Mono Line Input Channel to	
Insert Output	30 dB
Tape Output	40 dB
USB Output	30 dB
XLR Main Output	56 dB
Monitor Send	55 dB
FX Send	70 dB
Stereo Line Input Channel to	
Tape Output	30 dB
USB Output	20 dB
XLR Main Output	46 dB
Monitor Send	45 dB
FX Send	60 dB
Tape Input to	
Tape Output	20 dB
USB Output	10 dB
XLR Main Output	36 dB
USB Input to	
Tape Output	20 dB
USB Output	10 dB
XLR Main Output	36 dB
Stereo Return to	
Tape Output	10 dB
USB Output	0 dB
XLR Main Output	26 dB
Effects Return to	
Tape Output	10 dB
USB Output	0 dB
XLR Main Output	26 dB
Monitor Send	25 dB

Channel EQ

Low Cut	100 Hz, -18 dB/Octave
High Shelving	\pm 15 dB @ 12 kHz
Mid Peaking	\pm 15 dB @ 2.5 kHz
Low Shelving	\pm 15 dB @ 80 Hz

Digital Effects

I/O	Mono Input / Stereo Output
Number of Presets	16

Channel Level Set LED

0 dBu (normal operating level)

Channel OL LED

-1 dB before channel clipping
Measured post-EQ, pre-fader

Meters

Main L/R Mix
Two columns of 12 segments each:
OL (+20 dBu), +15, +10, +6, +3, 0 (0 dBu), -2, -4, -7, -10, -20, and -30

7 Band Graphic EQ

Frequency Centers 125, 250, 500, 1k, 2k, 4k, 8k
Gain ±15 dB
Assignable to Main or Monitor
Bypassable

USB

Format USB 1.1
I/O Stereo Input / Stereo Output
A/D/A 16 Bit, 44.1 kHz / 48 kHz

Phantom Power

48 VDC to all Mic channels at once

AC Power Requirements

Voltage Range 100 – 240 VAC, 50 – 60 Hz
Power Consumption: 20 Watts (ProFX8)
25 Watts (ProFX12)
Power Connector 3 Pin IEC

Dimensions (H x W x D)

ProFX8 14.05" x 11.41" x 3.58"
(357 mm x 290 mm x 91 mm)
ProFX12 14.05" x 14.6" x 3.58"
(357 mm x 370 mm x 91 mm)

Weight

ProFX8 7.1 lb (3.2 kg)
ProFX12 9.0 lb (4.1 kg)

Dimensions

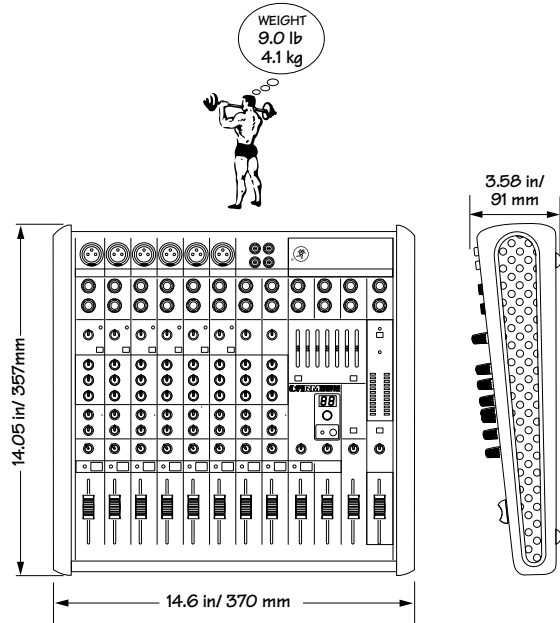
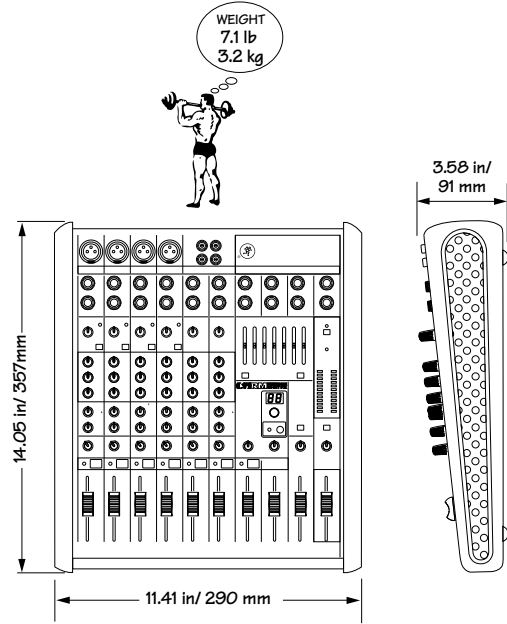

LOUD Technologies Inc. is always striving to improve our products by incorporating new and improved materials, components, and manufacturing methods. Therefore, we reserve the right to change these specifications at any time without notice.

“Mackie,” and the “Running Man” are registered trademarks of LOUD Technologies Inc. All other brand names mentioned are trademarks or registered trademarks of their respective holders, and are hereby acknowledged.

©2011 LOUD Technologies Inc. All Rights Reserved.

 **Correct disposal of this product.** This symbol indicates that this product should not be disposed of with your household waste, according to the WEEE Directive (2002/96/EC) and your national law. This product should be handed over to an authorized collection site for recycling waste electrical and electronic equipment (EEE). Improper handling of this type of waste could have a possible negative impact on the environment and human health due to potentially hazardous substances that are generally associated with EEE. At the same time, your cooperation in the correct disposal of this product will contribute to the effective usage of natural resources. For more information about where you can drop off your waste equipment for recycling, please contact your local city office, waste authority, or your household waste disposal service.

Block Diagram

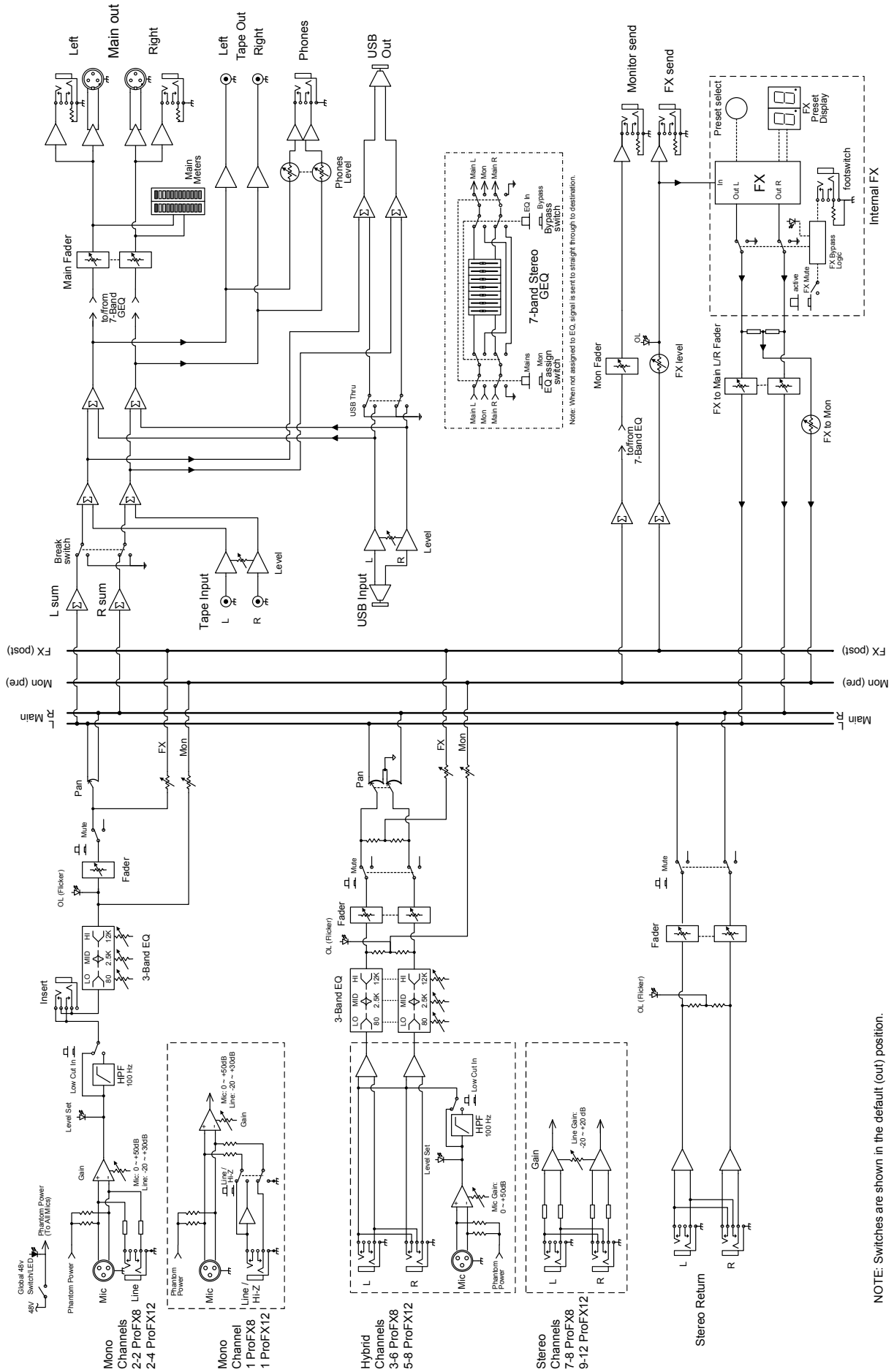

NOTE: Switches are shown in the default (out) position.

ProFX8 and ProFX12 Limited Warranty

Please keep your sales receipt in a safe place.

This Limited Product Warranty (“Product Warranty”) is provided by LOUD Technologies Inc. (“LOUD”) and is applicable to products purchased in the United States or Canada through a LOUD-authorized reseller or dealer. The Product Warranty will not extend to anyone other than the original purchaser of the product (hereinafter, “Customer,” “you” or “your”).

For products purchased outside the U.S. or Canada, please visit www.mackie.com/warranty to find contact information for your local distributor, and information on any warranty coverage provided by the distributor in your local market.

LOUD warrants to Customer that the product will be free from defects in materials and workmanship under normal use during the Warranty Period. If the product fails to conform to the warranty then LOUD or its authorized service representative will at its option, either repair or replace any such nonconforming product, provided that Customer gives notice of the noncompliance within the Warranty Period to the Company at: www.mackie.com/support or by calling LOUD technical support at 1.800.898.3211 (toll-free in the U.S. and Canada) during normal business hours Pacific Time, excluding weekends or LOUD holidays. Please retain the original dated sales receipt as evidence of the date of purchase. You will need it to obtain any warranty service.

For full terms and conditions, as well as the specific duration of the Warranty for this product, please visit www.mackie.com/warranty.

The Product Warranty, together with your invoice or receipt, and the terms and conditions located at www.mackie.com/warranty constitutes the entire agreement, and supersedes any and all prior agreements between LOUD and Customer related to the subject matter hereof. No amendment, modification or waiver of any of the provisions of this Product Warranty will be valid unless set forth in a written instrument signed by the party to be bound thereby.

MACKIE®

16220 Wood-Red Road NE • Woodinville, WA 98072 • USA

United States and Canada: 800.898.3211

Europe, Asia, Central and South America: 425.487.4333

Middle East and Africa: 31.20.654.4000

Fax: 425.487.4337 • www.mackie.com

E-mail: sales@mackie.com